

# Eaton® 9PXM UPS

4–20 kVA

User's Guide

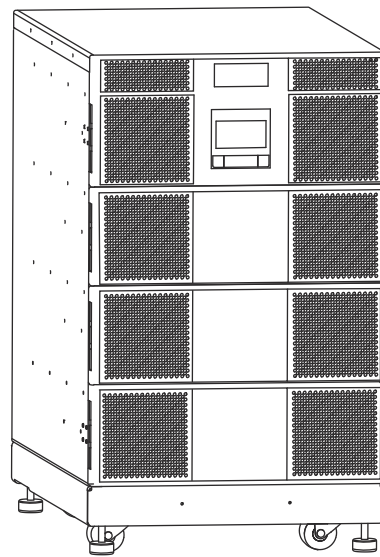
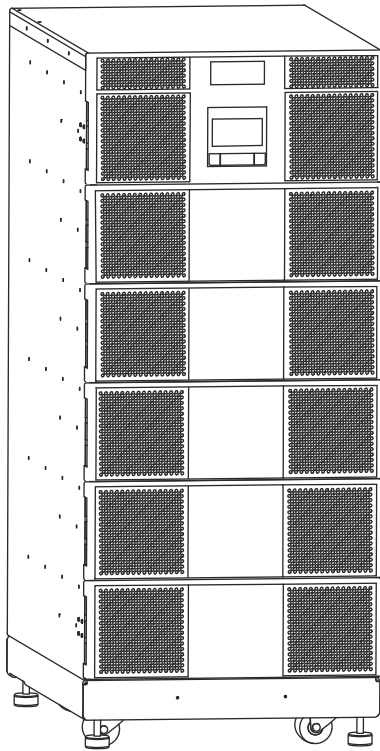

# EATON

*Powering Business Worldwide*



# Eaton® 9PXM UPS

4–20 kVA

User's Guide

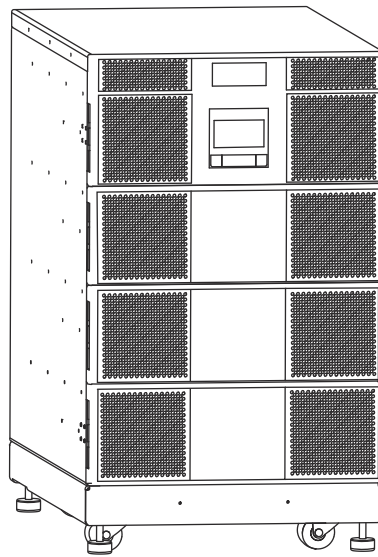
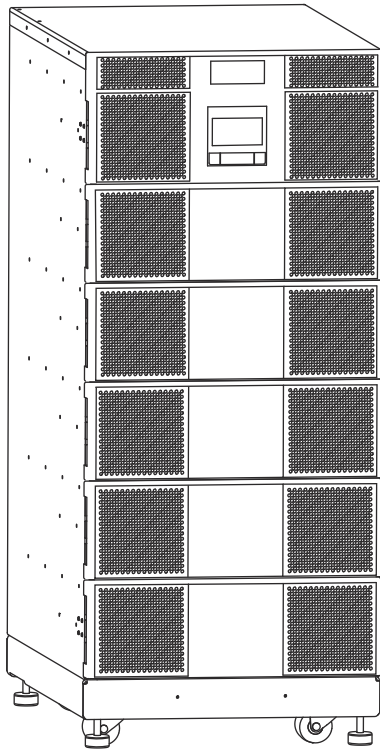

# EATON

*Powering Business Worldwide*

Eaton 9PXM is a registered trademark and PredictPulse, ConnectUPS, and BestDock are trademarks of Eaton or its subsidiaries and affiliates. Phillips is a registered trademark of Phillips Screw Company. Torx is a registered trademark of Textron, Inc. National Electrical Code and NEC are registered trademarks of National Fire Protection Association, Inc. All other trademarks are property of their respective companies.

©Copyright 2000–2018 Eaton, Raleigh, NC, USA. All rights reserved. No part of this document may be reproduced in any way without the express written approval of Eaton.

## **Class A EMC Statements**

### **FCC Part 15**

**Note:** This equipment has been tested and found to comply with the limits for a Class A digital device, pursuant to part 15 of the FCC Rules. These limits are designed to provide reasonable protection against harmful interference when the equipment is operated in a commercial environment. This equipment generates, uses, and can radiate radio frequency energy and, if not installed and used in accordance with the instruction manual, may cause harmful interference to radio communications. Operation of this equipment in a residential area is likely to cause harmful interference in which case the user will be required to correct the interference at his own expense.

### **ICES-003**

This Class A Interference Causing Equipment meets all requirements of the Canadian Interference Causing Equipment Regulations ICES-003.

Cet appareil numérique de la classe A respecte toutes les exigences du Règlement sur le matériel brouilleur du Canada.

### **EN 62040-2**

Some configurations are classified under EN 62040-2 as "C2 UPS for Unrestricted Sales Distribution."

## Special Symbols

The following are examples of symbols used on the UPS or accessories to alert you to important information:



**RISK OF ELECTRIC SHOCK** - Observe the warning associated with the risk of electric shock symbol.



**CAUTION: REFER TO OPERATOR'S MANUAL** - Refer to your operator's manual for additional information, such as important operating and maintenance instructions.



This symbol indicates that you should not discard the UPS or the UPS batteries in the trash. This product contains sealed, lead-acid batteries and must be disposed of properly. For more information, contact your local recycling/reuse or hazardous waste center.



This symbol indicates that you should not discard waste electrical or electronic equipment (WEEE) in the trash. For proper disposal, contact your local recycling/reuse or hazardous waste center.

# Table of Contents

<b>1</b>	<b>INTRODUCTION</b> .....	<b>1</b>
	Safety Warnings .....	1
	Physical Features .....	3
<b>2</b>	<b>INSTALLATION SETUP</b> .....	<b>9</b>
	Equipment Clearances .....	9
	Location Requirements .....	9
	UPS Setup .....	9
	Eight- and Twelve-Slot Cabinets .....	9
	Anchor Bracket Installation .....	11
	Rack-Mount Installation .....	12
<b>3</b>	<b>UPS WITH BYPASS ELECTRICAL INSTALLATION</b> .....	<b>15</b>
	Circuit Breaker Input Current Ratings .....	16
	Bypass Module Installation .....	17
	UPS Connections .....	17
	Input Signal Wire Routing .....	21
	System Wiring Diagram .....	23
	Bypass Overview .....	26
	Bypass Module Operation .....	27
	No Break Transfer from UPS Mode to Service Mode .....	27
	Lock-out/Tag-out .....	28
	No Break Transfer from Service Bypass to UPS Mode .....	28
<b>4</b>	<b>UPS ELECTRICAL INSTALLATION</b> .....	<b>31</b>
	Input Current Ratings .....	31
	UPS Electrical Installation .....	32
	System Wiring Diagram .....	36
<b>5</b>	<b>BATTERY CABINET INSTALLATION</b> .....	<b>39</b>
	Prepare the EBM cabinet: .....	39
	Connecting the EBM(s) to the UPS .....	41
<b>6</b>	<b>UPS STARTUP</b> .....	<b>47</b>
	Power Module and Battery Module Installation .....	47
	UPS Startup .....	50
	Initial Startup Parameters .....	51
<b>7</b>	<b>OPERATION</b> .....	<b>53</b>
	Normal Operation .....	53
	UPS Standby Mode .....	53
	UPS Shutdown .....	53
	Operating modes .....	53
	Online Mode .....	53
	Battery Mode .....	54
	Low-Battery Warning .....	54
	End of Battery Backup Time .....	54
	Bypass Mode .....	54
	Return of AC Input Power .....	54
	Setting High Efficiency Mode .....	55
	Configuring Bypass Settings .....	55
	Bypass Voltage Min Limit .....	55

# Table of Contents

Bypass Voltage Max Limit . . . . .	55
Protected Bypass (Enabled) . . . . .	55
Unsynchronized Transfers . . . . .	55
Configuring battery settings . . . . .	55
Advanced Battery Management . . . . .	56
Auto Battery Test . . . . .	56
Low Battery Warning . . . . .	56
External Battery Setting . . . . .	56
Deep Discharge Protection . . . . .	56
Retrieving the Event log . . . . .	56
Retrieving the Fault log . . . . .	56
Control Panel Operation . . . . .	57
Display functions . . . . .	57
LCD Description . . . . .	58
Display Status Indicators . . . . .	59
Changing Parameter Settings . . . . .	59
Display Menu Screens . . . . .	60
Start Screen . . . . .	60
Status Screen . . . . .	60
Menu Screen . . . . .	60
Measurements . . . . .	61
Control . . . . .	62
Local Settings . . . . .	63
In/Out Settings . . . . .	64
On/Off Settings . . . . .	65
Input Signals . . . . .	67
Comm Settings . . . . .	68
User Password Settings . . . . .	69
Event Log . . . . .	69
Fault Log . . . . .	69
Identification . . . . .	70
Registration Information . . . . .	70
<b>8 COMMUNICATION . . . . .</b>	<b>71</b>
Intelligent Power Manager . . . . .	71
Optional Interface Kits . . . . .	71
Communication Ports . . . . .	71
UPS Communication Ports . . . . .	71
EBM Communication Ports . . . . .	72
Dedicated Input Signals . . . . .	72
DB-9 Communication Port . . . . .	73
Communication Slots . . . . .	73
Network Card MS . . . . .	73
PXGX UPS Card . . . . .	74
Network and Modbus Card MS . . . . .	74
Relay Card-MS . . . . .	74
<b>9 MAINTENANCE . . . . .</b>	<b>75</b>
Routine Maintenance . . . . .	75
Storage Temperature . . . . .	75
External Bypass Switch (Make-Before-Break Only) Operation . . . . .	75
Battery Replacement . . . . .	75
Power Module Replacement . . . . .	76



- UPS Firmware Upgrade ..... 78
  - Prerequisites ..... 78
  - Unpacking the Downloaded Zip File ..... 78
  - Launch the Firmware Upgrade Tool..... 80
  - USB Connection to the UPS (Initial Required Step for USB Connections Only) 80
  - UPS CSB firmware Upgrade ..... 81
  - UPS UPM or EBM UPM and SuperCharger Firmware Upgrade ..... 83
- 10 SPECIFICATIONS ..... 87**
  - Nominal Electrical Input and Output ..... 87
  - Combined UPM Power Ratings..... 87
  - Circuit Breakers ..... 88
  - Environmental and Safety ..... 88
  - Battery Ratings ..... 89
  - Output Run Times ..... 89
  - Weights and Dimensions..... 89
  - Output Receptacles..... 90
- 11 TROUBLESHOOTING ..... 91**
  - Troubleshooting ..... 91
    - Typical Alarms and Faults ..... 91
    - Silencing the Alarm ..... 92
  - Frequently Asked Questions..... 93
  - Service and Support ..... 94
- 12 WARRANTY ..... 95**

This page intentionally left blank.

## List of Figures

Eight and Twelve-Slot Cabinets (Front View) . . . . .	3
Twelve-Slot Rear View Access . . . . .	4
Power Modules and Battery Slots . . . . .	5
Battery Modules per Slot . . . . .	5
Uninterruptible Power Module . . . . .	6
UPS Control Panel . . . . .	7
UPS on Shipping Pallet . . . . .	10
Moving the UPS from the Pallet . . . . .	10
Floor Anchor Bracket Installation . . . . .	11
Rack-Mount Ear Installed . . . . .	12
Rack Tray Location . . . . .	13
Remove Cabinet from Caster Tray . . . . .	14
Securing the UPS in the Rack . . . . .	14
Typical Installation with a Bypass Switch . . . . .	15
UPS AC Power Terminal Access . . . . .	18
UPS Input Wiring . . . . .	19
UPS Input and Output Terminals . . . . .	20
Bypass Switch Wiring Label and Terminal Blocks . . . . .	21
UPS Input Control Signal Wiring for Maintenance Bypass . . . . .	22
Wiring Diagram - UPS with External Bypass Switch (L1, L2, N) . . . . .	24
Wiring Diagram - UPS with External Bypass Switch (L1, L2, N) and MBB Option . . . . .	25
Bypass Switch Positions . . . . .	26
Bypass From UPS to LINE . . . . .	27
Bypass From LINE to SERVICE . . . . .	28
LOTO Feature . . . . .	28
From SERVICE to LINE . . . . .	29
From LINE to UPS . . . . .	29
Typical Installation without a Bypass Switch . . . . .	31
UPS Power Terminals . . . . .	33
UPS Input Wiring . . . . .	34
UPS Input and Output Terminal Connections . . . . .	34
Wiring Diagram - UPS with No External Bypass (L1, L2, N) . . . . .	37
UPS Connections . . . . .	40
Battery Cable Assembly Installation. . . . .	41
Split-Phase Input . . . . .	41
Single Phase Input . . . . .	42
No AC Input . . . . .	42
EBM to UPS Connections . . . . .	43
UPS Input Control Signal Wiring (for External Controls) . . . . .	43
CAN and Chassis Ground Wires EBM to EBM . . . . .	44
CAN and Chassis Ground Wires EBM to UPS . . . . .	44
EBM Emergency Disconnect Switch . . . . .	45
Inserting the Modules . . . . .	48
EBM Battery Modules and Charger . . . . .	49
Communication Ports . . . . .	50
UPS Control Panel . . . . .	57
LCD Display Status Indicators . . . . .	58
Status Indicators . . . . .	59
Start Screen Menu . . . . .	60
Status Screen Menu . . . . .	60

## List of Figures

Menu Screen	60
Measurements Menu	61
Control Menu	62
Local Settings Menu	63
In/Out Settings Menu	64
On/Off Settings Menu	65
Battery Settings Menu	66
Input Signals Menu	67
Comm Settings Menu	68
Password Menus	69
Event Log Menu	69
Fault Log Menu	69
Identification Menu	70
Register Product Menu	70
UPS Communication Ports	71
EBM Communication Ports	72
Battery Replacement	76
Power Module Replacement	77
Extract Zip File to Unzip Folder	78
Create Unzip Folder	79
Enter Extraction Password	79
Extracted Firmware Files	80
Firmware Upgrade Tool Window	80
Windows Drivers	81
Window Device Manager Selection	81
CSB Upgrade Selection	82
Upgrade Initialization	82
Communication Types	83
UPM - EBM/Supercharger Firmware Menu	83
Firmware Comm Port Selection	84
Installation Start	84
Flash Data	85
Programming Address	85
Flash Data Complete	85
Compatible Output Receptacles	90
Event Log Menu	91

## Chapter 1 Introduction

The Eaton® 9PXM uninterruptible power system (UPS) is a modular UPS that contains two battery modules per slot (two-battery slot) and power control modules (referred to as power modules). These modules plug into a rack cabinet structure containing additional control, communication and display functions that enable integrated control of all power modules. The UPS is housed in a single cabinet with either eight or twelve slots which may be either floor or rack-mounted. Optional extra battery capacity is housed in extended battery module (EBM) cabinets.

The twelve-slot UPS cabinet can accommodate a maximum of six power modules and two battery modules per slot in the remaining six slots. However, if a customer chooses to only have one power module they can install two battery modules per slot in the remaining eleven slots. The eight-slot cabinet can accommodate the same configuration with two less total units each. Both UPS cabinet models allow their output to be limited such that an excess number of power modules allow the failure of one or more modules without causing the UPS to lose any functionality. Optional super charger modules can be installed in the power module slots.

The power modules can be removed and replaced (easily replaceable) without powering the UPS down if the UPS has sufficient redundant capacity. Battery modules (2 battery modules per slot) may also be easily replaced for maintenance. Power control circuitry in the cabinet senses problems in power modules, and automatically transfers control and load to the remaining power modules. Battery modules and Power modules are accessed through removable front panels.

All power modules share the load requirements equally. For example, three power modules are capable of supplying a total of 12 kVA. If a load requires only 6 kVA, each power module supplies 2 kVA to the output. If one power module is removed or for some reason fails, each of the two remaining power modules would supply half of the load, or 3 kVA. In other words, redundancy exists when the load can be supplied by less than all of the installed power modules.

To permit UPS removal from the power path while maintaining power to the loads, an external bypass switch is required. This switch is optional but recommended for system serviceability.

### Safety Warnings

---

#### **IMPORTANT SAFETY INSTRUCTIONS — SAVE THESE INSTRUCTIONS**

---

This manual contains important instructions that you should follow during installation and maintenance of the UPS and batteries. Please read all instructions before operating the equipment and save this manual for future reference.

---

- The 9PXM is a modular UPS with a power range of 4kVA to 20kVA. Each Power Module is rated for up to 4kVA. The 20kVA (N+1) Split-Phase model chassis will have twelve slots, two per row. All of the twelve slots can accommodate two battery modules per slot. The Power Modules will be restricted to the slots in only the left side of the chassis, when viewed from the front. A super charger can be installed in any of the power module slots. This super charger can also be used in an external battery module (EBM). The 16kVA (12kVA (N+1)) Models will be similar but will have eight slots.
- Do NOT install more than six power and/or optional super charger modules in the system.
- Battery modules to be used in the Eaton 9PXM system are model P-103002954. Each battery module weighs 15 kg (33 lb). Use care in lifting and moving battery modules.
- All input and output wiring must be copper and adequate to carrying currents as listed in Table 9 on page 87.
- Torque all bolts holding input and output power conductors to values specified in Table 2 on page 16.
- The user is required to provide power input and output disconnect devices for the UPS. These must be within sight of the UPS and easily accessible.

### Consignes de Sécurité

---

#### **CONSIGNES DE SÉCURITÉ IMPORTANTES — CONSERVER CES INSTRUCTIONS**

---

Ce manuel comporte des instructions importantes que vous êtes invité à suivre lors de toute procédure d'installation et de maintenance des batteries et de l'onduleur. Veuillez consulter entièrement ces instructions avant de faire fonctionner l'équipement et conserver ce manuel afin de pouvoir vous y reporter ultérieurement.

---

- Les blocs de puissance à phase auxiliaire sont dotés d'étiquettes marron sur le dessus et produisent deux tensions de sortie: 110/110 pour 220, 120/120 pour 240, 120/120 pour 208, ou 127/127 pour 220 Vca.
  - N'installez PAS plus de six chargeurs de batteries optionnels et/ou de puissance dans le système.
  - Les modules de batterie à utiliser dans le système Eaton 9PXM correspondent au modèle P-103002954. Chaque module de batterie pèse 15 kg (33 lb). Levez ou déplacez les modules de batterie avec soin.
  - Tous les câblages d'entrée et de sortie doivent être en cuivre et doivent prendre en charge les courants répertoriés dans les Table 9 des pages 87.
  - Couplez tous les boulons en maintenant les conducteurs de sortie sur les valeurs indiquées dans le Table 2 à la page 16.
  - L'utilisateur doit fournir des appareils de déconnexion de l'alimentation en entrée et en sortie pour l'onduleur. Ceux-ci doivent se trouver dans le périmètre de l'onduleur et être faciles d'accès.
- 

### Advertencias de Seguridad

---

#### **INSTRUCCIONES DE SEGURIDAD IMPORTANTES — GUARDE ESTAS INSTRUCCIONES**

---

Este manual contiene instrucciones importantes que debe seguir durante la instalación y el mantenimiento del SIE y de las baterías. Por favor, lea todas las instrucciones antes de poner en funcionamiento el equipo y guarde este manual para referencia en el futuro.

---

- Los módulos de potencia de fase dividida portan etiquetas de color café en la parte delantera y producen dos voltajes de salida: 110/110 para 220, 120/120 para 240, 120/120 para 208 ó 127/127 para 220 Vca.
- NO instale en los módulos de potencia del sistema más de seis módulos de potencia y/o de cargadores opcionales de baterías.
- Los módulos de baterías a utilizarse en el sistema Eaton 9PXM son del modelo P-103002954. Cada módulo de batería pesa 15 kg (33 lb). Levante y mueva con cuidado los módulos de baterías.
- Todo el cableado de entrada y de salida debe ser de cobre y del tipo adecuado para transportar las corrientes detalladas en la Table 9 y en las páginas 87 .
- Apriete todos los pernos que sostengan los conductos de alimentación de entrada y de salida según los valores de torsión especificados en la Table 2, en la página 16.
- Se le solicita al usuario suministrar dispositivos de desconexión de entrada y salida de alimentación para el SIE. Éstos deben estar a la vista del SIE y ser de fácil acceso.

## Physical Features

The Eaton 9PXM UPS is available in eight or twelve-slot cabinet sizes. The cabinet front has a control panel and magnetic-latch front covers that provide access to the power modules and battery modules. Casters and leveling feet are installed on a caster tray for a floor-mounted UPS installation (see Figure 1).

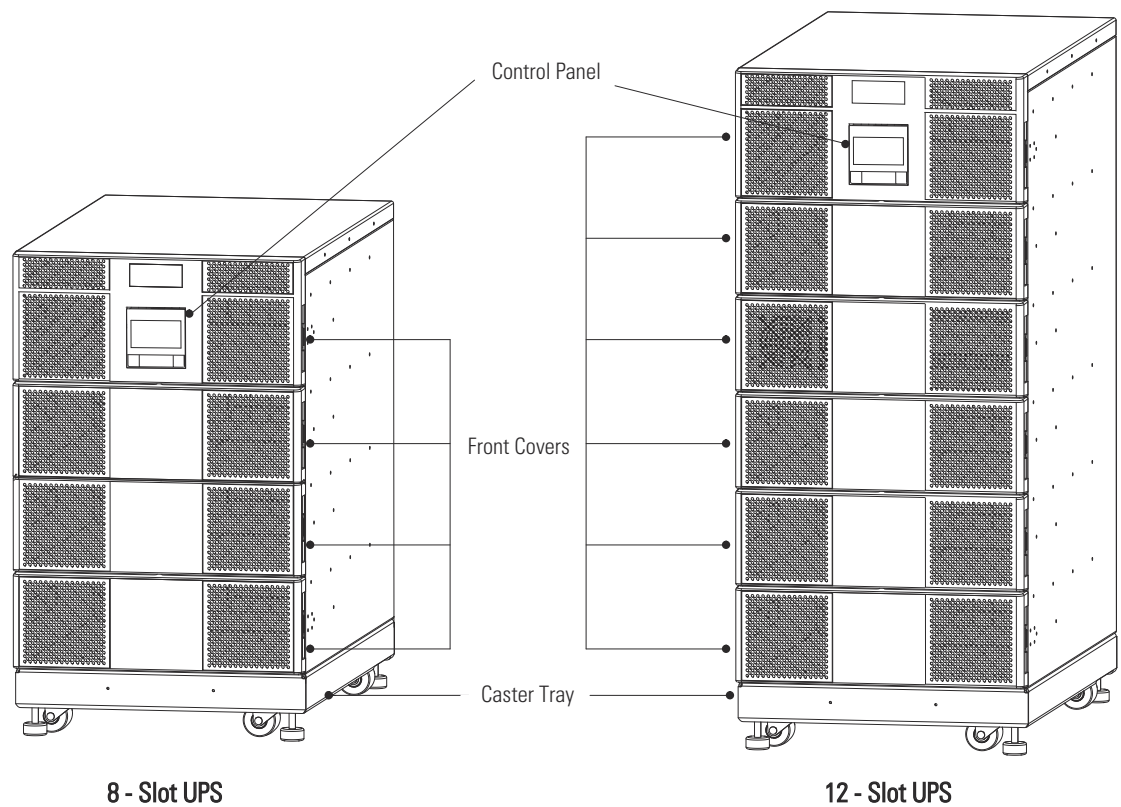

**Figure 1. Eight and Twelve-Slot Cabinets (Front View)**

The rear UPS panel features power input and output connections with protective covers. Communication ports provide input signals for maintenance bypass, remote power off, etc. DB-9, USB ports and communication slots for network connectivity cards allow for remote monitoring of UPS operation. Slots for output receptacles installed by Eaton are available by removable knockout panels depending on the user's requirements (see Figure 2).

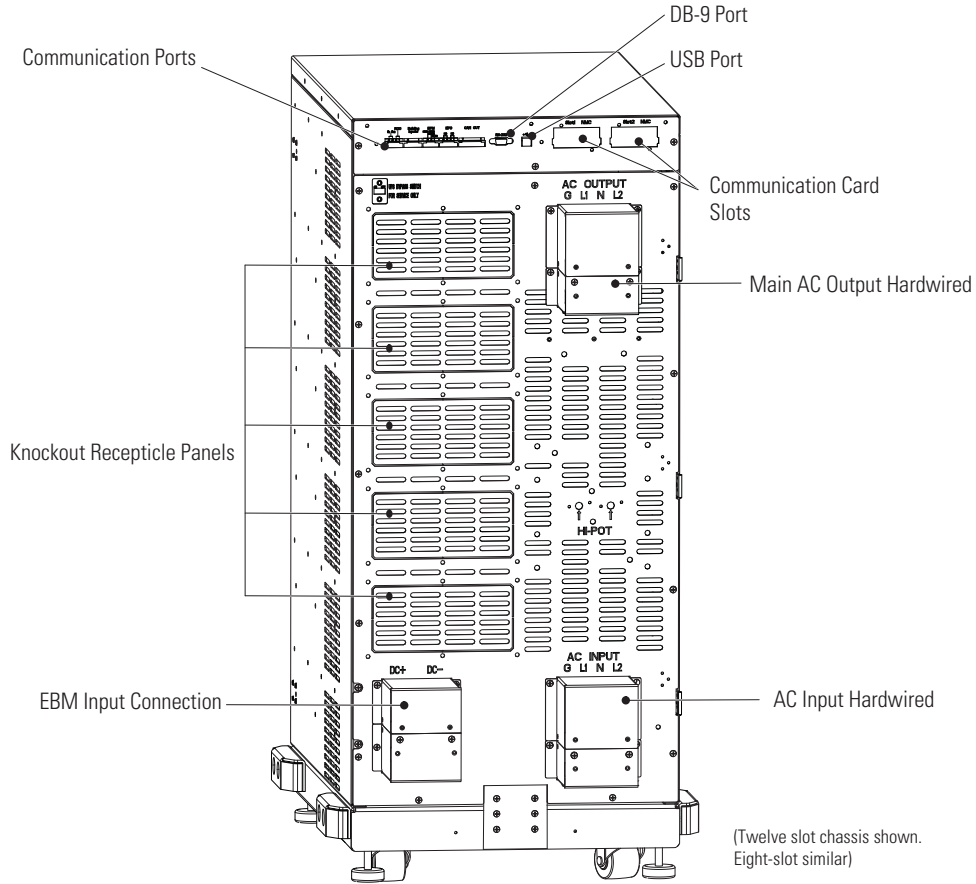

**Figure 2. Twelve-Slot Rear View Access**



UPS power modules (UPMs) are installed in the left hand slots of the UPS facing the user behind the front covers. Battery slots consist of two battery modules each and can be used in both the right or left hand slots. For the twelve-slot cabinet, a minimum of one UPM and up to eleven two-battery slots each can be used in the 9PXM. One UPM and seven two-battery slots can be used in an eight-slot cabinet (see Figure 3).

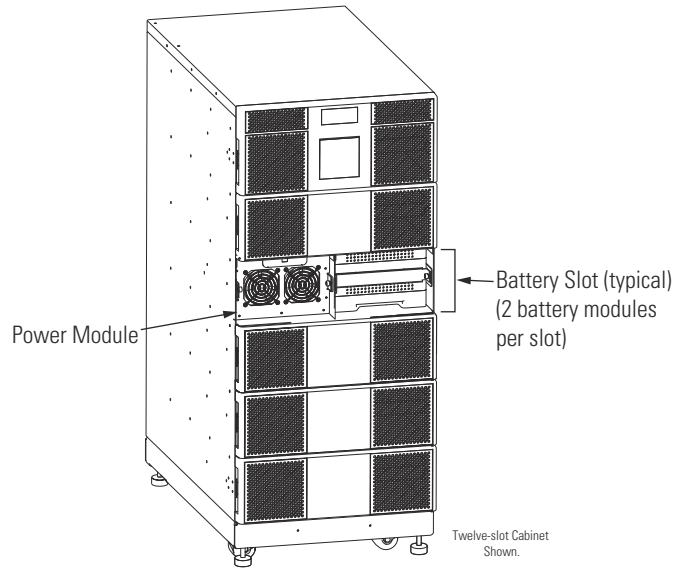

**Figure 3. Power Modules and Battery Slots**

#### **Battery Modules**

As a UPS, the eight-slot 9PXM chassis can accommodate a maximum of seven two-battery slots and the twelve-slot can contain up to eleven two-battery slots. Each two-battery slot contains two battery modules that can be removed and installed separately from the battery slots in the chassis. A battery module supplies 60VDC with five 12V batteries, each 9PXM battery two-battery slot supplies 120VDC, with 10 batteries (see Figure 4).

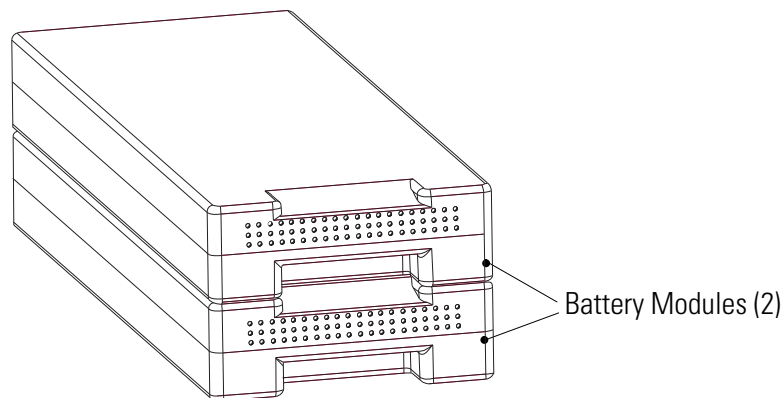

**Figure 4. Battery Modules per Slot**

### **Uninterruptible Power Modules (UPM)**

The eight-slot 9PXM chassis can accommodate a maximum of four power modules and the twelve-slot can contain up to six modules. Each 4kVA has a built in 5 Amp battery charger and is cooled by two cooling fans.(see Figure 5).

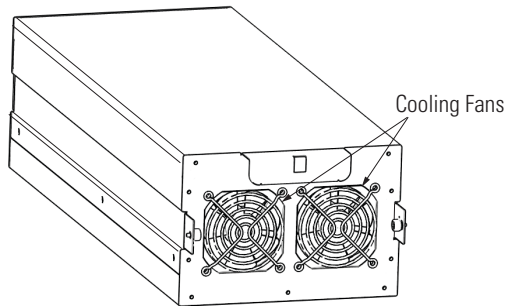

**Figure 5. Uninterruptible Power Module**

### **Super Charger Modules (Optional)**

Super chargers have a built in 20A charger and charge the batteries and are identical in appearance to power modules. They are identified separately from each other by their labels. The UPS can contain a minimum of one super charger while External Battery Modules (EBMs) can accommodate one in the lower left slot. One super charger is able to fully charge the batteries of a fully-loaded EBM (max 11 two-battery slots).

### Control Panel

The UPS control panel has a graphical LCD screen, light indicators and function buttons. It provides information and control for the UPS, load status, events, measurements and settings. Refer to Chapter 7, "Control Panel Operation" on page 57 for control panel description and operation.

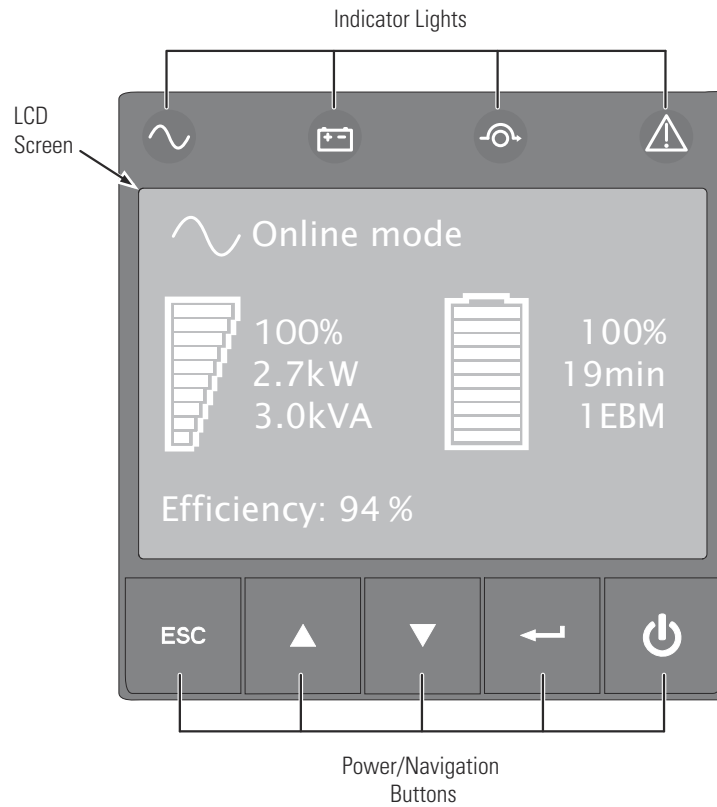

**Figure 6. UPS Control Panel**

This page intentionally left blank.

## Chapter 2 Installation Setup

This chapter explains how to set up and install the Eaton 9PXM eight and twelve-slot cabinets:

- Equipment Clearances
- Location Requirements
- UPS Setup
- Anchor Bracket Installation
- Rack-mount installation

### Equipment Clearances

All cabinet sizes require the following clearances to allow for servicing and adequate ventilation:

- Sides: 15.2 cm (6")
- Top and back: 30.5 cm (12")
- Front: 91.5 cm (36")

If flexible conduit connects the UPS to the service input and load distribution panels, you may be able to gain access for servicing by moving the UPS. If this is the case, you must still leave 30.5 cm (12") clearance at the back and 15.2 cm (6") at the sides of the UPS for ventilation.



**NOTE** Do not block the ventilation holes on each side and the back of the cabinet.

---

External battery cabinets may be installed with bases tight against the UPS cabinet base and against each other.

### Location Requirements

Install the Eaton 9PXM UPS as close as possible to the equipment or the load distribution panel it will protect.

If a separate external battery cabinet (EBM) is installed, the battery cabinets must be adjacent to the Eaton 9PXM UPS. If the batteries will be farther from the cabinet than the standard cables allow, contact your service representative or your local distributor for assistance.

UPS cabinet dimensions are located in Chapter 10, "Weights and Dimensions" on page 89.

### UPS Setup

The Eaton 9PXM UPS eight and twelve-slot cabinets are shipped on a shipping pallet. Power modules and battery modules are shipped in separate boxes on another pallet.



**NOTE** Installation for the eight-slot cabinets are identical to the twelve-slot cabinets. Twelve-slot cabinets are shown in these set up instructions.

---

### Eight- and Twelve-Slot Cabinets



**CAUTION**

Do NOT or attempt to move the cabinet with the power modules or battery modules installed.

---

To set up 8- or 12-slot cabinets:

1. Move the UPS shipping pallet close to the desired location.
2. If installed, remove the straps and bracket bolts that attach the UPS to the pallet (see Figure 7).
3. If you are rack-mounting the UPS, proceed to “Rack-Mount Installation” on page 12.

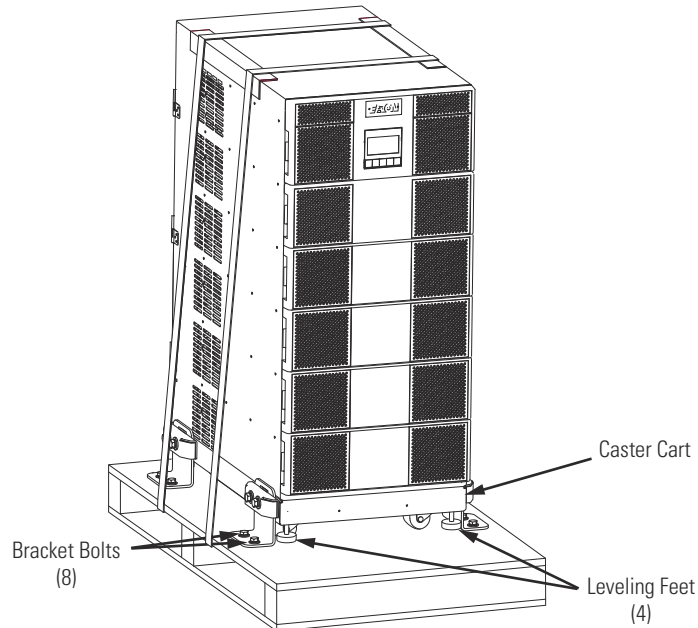

**Figure 7. UPS on Shipping Pallet**

4. Attach the supplied ramp to the pallet with the two brackets and four wood screws provided (see Figure 8).
5. Retract the leveling feet by turning them clockwise then carefully roll the cabinet down the ramp to its intended operating location (see Figure 8).

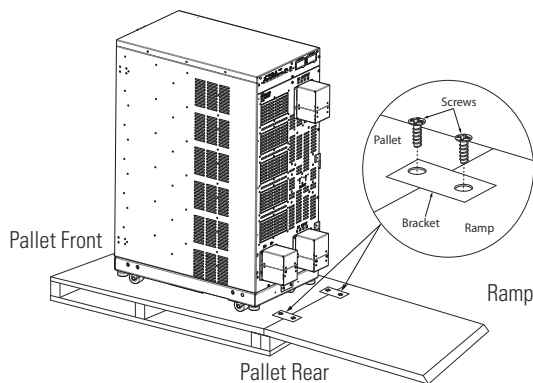

**Figure 8. Moving the UPS from the Pallet**



**NOTE**

For ease of installation, determine if you have sufficient clearance at the rear of the UPS to complete the electrical connections before securing the UPS in its final position (see Chapter 4, “UPS Electrical Installation”)

6. Stabilize the cabinet at its operating location by extending the four leveling feet until the cabinet rests on the floor.

---

**i NOTE** If the floor is uneven and the cabinet is tilted or unstable, you may need to place a thin steel plate under a corner.

---

7. If you are installing the floor anchors and they are not already installed, see “Anchor Bracket Installation” in the next section to install the floor anchor brackets.
8. If you are installing an external battery cabinet, continue to “Battery Cabinet Installation” on page 39.
9. Continue to “UPS with Bypass Electrical Installation” on page 15 or “UPS Electrical Installation” on page 31, as applicable

### Anchor Bracket Installation

---

**i NOTE** For ease of installation, complete the rear electrical connections before securing the anchor brackets to the floor (Chapter 4, “UPS Electrical Installation”)

---

The Eaton 9PXM UPS cabinet is shipped with four anchor (stabilizer) brackets (Kit P-157002300). These brackets must be attached to the floor. Under all module-loading conditions, they act as a protective stop to prevent the cabinet from falling forward if it is unintentionally pushed.

Each bracket has holes that enable it to be attached by screws to the floor (see Figure 9). The anchor brackets are attached to the cabinet base itself.

To install the stabilizer brackets:

1. Select the location for the brackets at the floor intersection beside the intended cabinet location.
2. Attach the brackets to the cabinet base as shown in Figure 9
3. Roll the UPS cabinet to its intended location. Position the rear section of the cabinet base under the open ends of the stabilizer brackets as far as the cabinet will go.
4. Turn all four leveling feet counter-clockwise until the cabinet rests on the floor.
5. Using the proper type of customer-supplied screws for the intended mounting surface, attach each bracket as shown in Figure 9. All screws must be properly driven into the structural material.

---

**i NOTE** If the floor is uneven and the cabinet is tilted or unstable, you may need to place a thin steel plate under a corner. Do not use the caster bolts to level the cabinet.

---

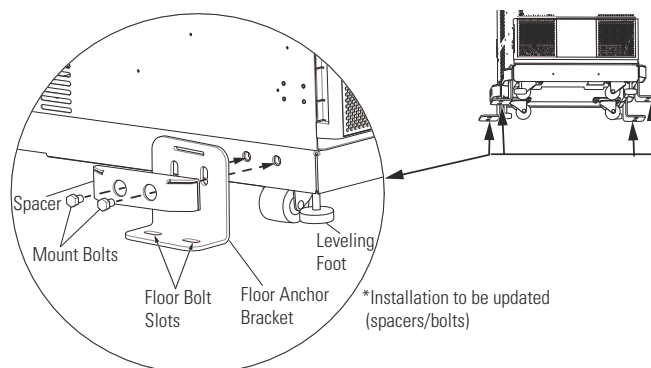

**Figure 9. Floor Anchor Bracket Installation**

## Rack-Mount Installation

---

**CAUTION**

---

The 12-slot UPS weighs 93 kg (204 lb) with the caster cart. Install the cabinet in the rack before installing power and battery modules and before making connections to the intended power source.

---

The Eaton 9PXM UPS and the battery cabinet are very heavy with power modules and two battery modules per slot installed. If installed, before moving the cabinets, remove the power modules and battery two battery modules per slot (see "Power Module and Battery Module Installation" on page 47).

---

**NOTE** The UPS cabinets may be installed in an EIA-standard 48.3 cm (19") equipment rack. An optional rack-mounting kit (P-157002204), containing brackets and required hardware, is available.



**NOTE** This procedure is also applicable to the P-103002494 12-slot external battery module (EBM).

---

Use the following mounting procedures to install the UPS cabinet into the equipment rack:

1. Install rack-mount ears (two per side) on each side of the UPS cabinet (see Figure 10).

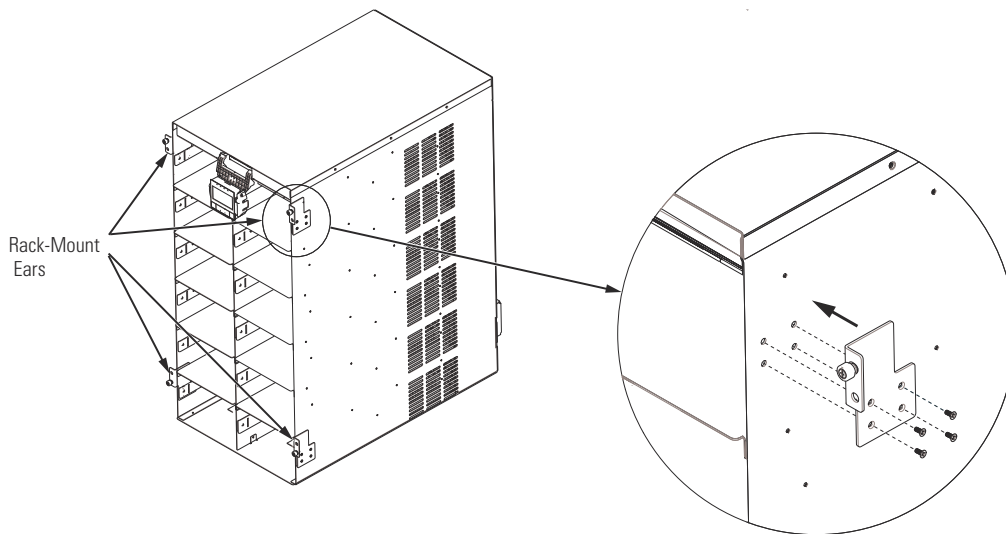

**Figure 10. Rack-Mount Ear Installed**

2. Select the proper holes in the front vertical rack rails that position the rack tray at the bottom in the rack and extend the back rails to align with the rear holes. Secure with the screws and washers (see Figure 11).



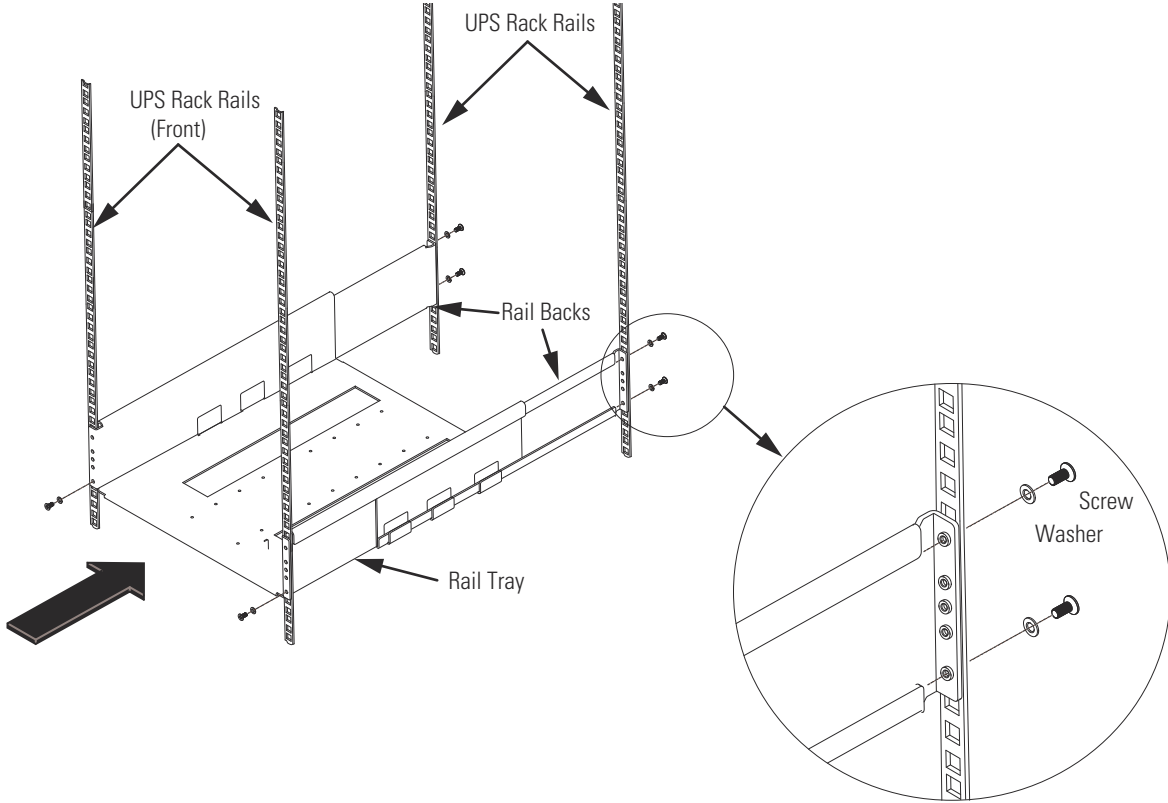

**Figure 11. Rack Tray Location**

- 3. Remove the cabinet from the caster cart as follows (see Figure 12):
  - a. Lower the leveling feet to stabilize the caster cart.
  - b. Remove the rear bracket and screws.
  - c. Using two people, slide the cabinet backwards to disengage it from the slot tabs.
  - d. Lift the cabinet off of the caster cart.

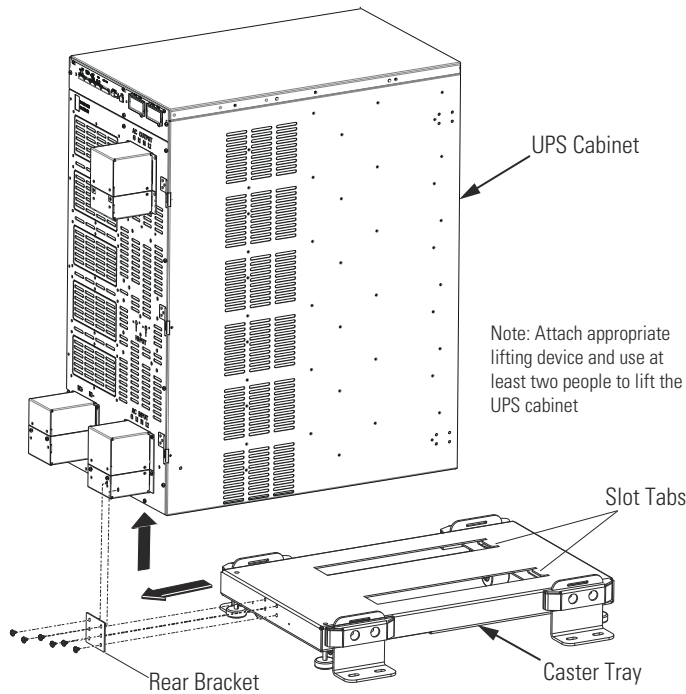

**Figure 12. Remove Cabinet from Caster Tray**

4. Carefully slide the UPS from the caster tray onto the rail tray in the equipment rack until the rack-mount ears of the cabinet are almost flush with the front vertical rails of the rack. Install metal clip nuts in the rack in line with the upper mounting brackets. Install the provided screws (see Figure 13).
5. Install the provided screws into the lower rack mount ears to the threaded holes in the rail tray (see Figure 13).

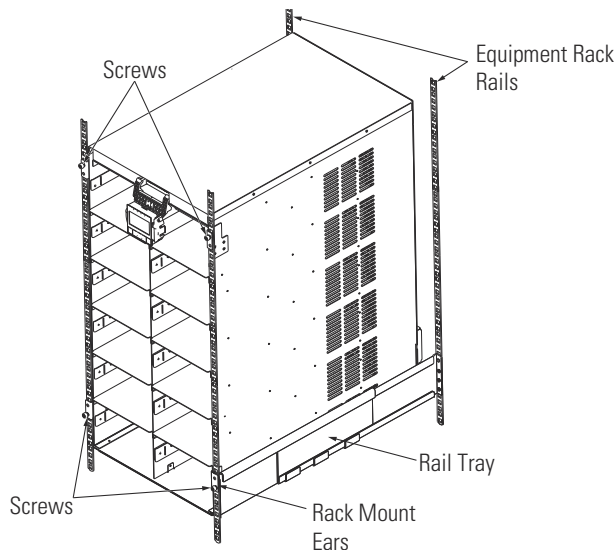

**Figure 13. Securing the UPS in the Rack**

6. If you are installing an optional EBM cabinet P-103002494, refer to Chapter 5, "Battery Cabinet Installation" on page 39.

## Chapter 3 UPS with Bypass Electrical Installation

The Eaton 9PXM UPS input power is hardwired through a conduit to either a main power source circuit breaker or to an optional bypass switch. It is recommended that you install an Eaton® Bypass Power Module (BPM) to enable power transfer during maintenance or UPS downtime.

### WARNING

Risk of electrical shock. Only qualified service personnel (such as a licensed electrician) should perform the electrical installation in this section.



**NOTE** For installation and configuration of the Eaton bypass switch refer to the manual “Eaton Bypass Power Module (BPM) User’s Guide P-164000628” supplied with the switch or on the Eaton website <http://www.eaton.com/Eaton/index.htm>.

If a bypass switch is used, both UPS input and UPS output must be hardwired — through separate conduits — to the bypass switch, as shown in Figure 14.

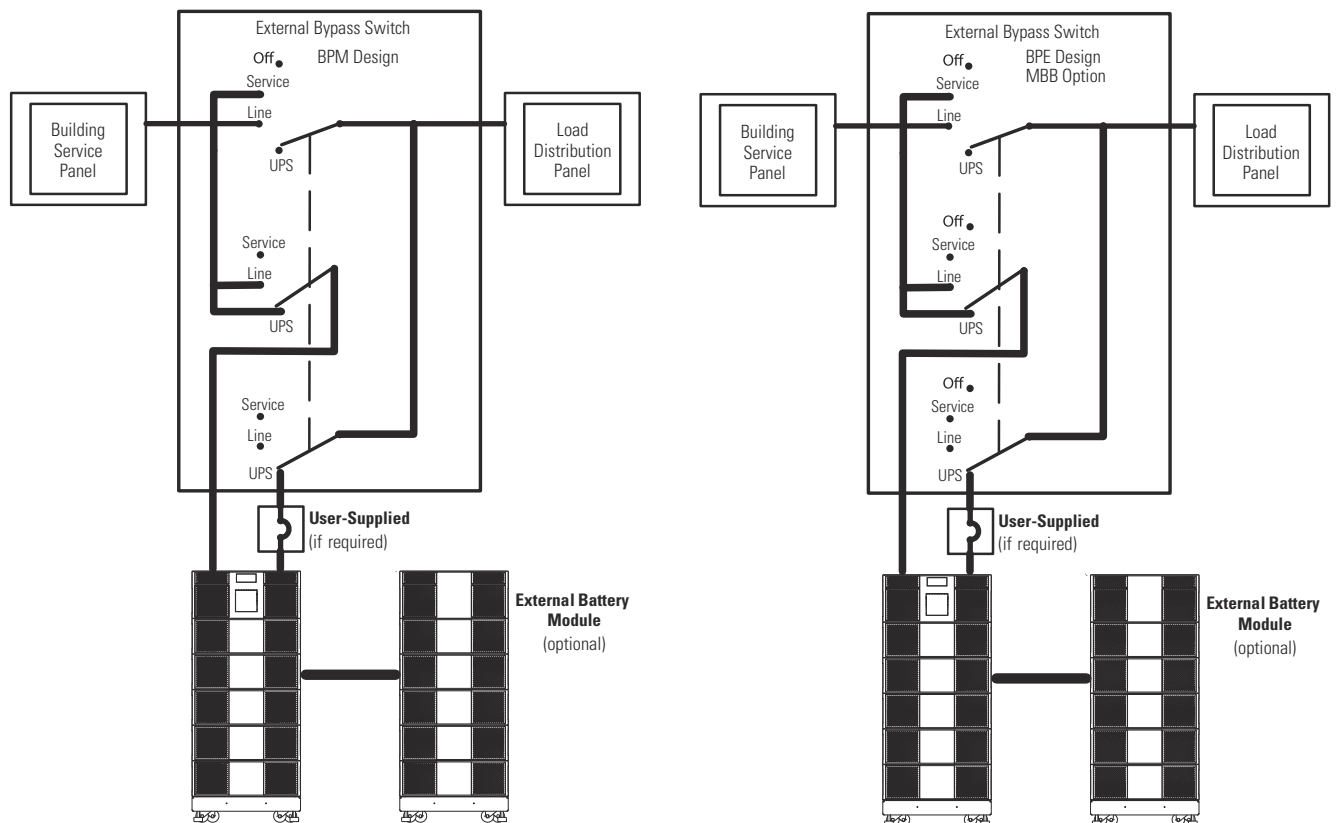

**Figure 14. Typical Installation with a Bypass Switch**

## Circuit Breaker Input Current Ratings

Table 1 contains the required circuit breaker ratings for hardwired installations.

**Table 1. Required Input Circuit Breaker Sizes (120/208 Vac or 120/240 Vac, 60 Hz)**

UPS Capacity	Input Circuit Breaker Rating
4 kVA	25A
8 kVA	50A
12 kVA	75A
16 kVA	100A
20 kVA	125A

**NOTE 1** If you are installing an optional super charger module, refer to that user's guide for the proper input circuit breaker sizes and ratings.



**NOTE 2** To accommodate the feature of easy system expandability, it is recommended that initial installation of the Eaton 9PXM UPS contains wiring to support the maximum capacity of the UPS cabinet of 20kVA for 12-slot and 16-kVA for 8-slot cabinets.

See Table 2 for recommended conductor sizes to wire the input circuit breakers.

**Table 2. Recommended Wire Sizes**

Input Circuit Breaker Size	75°C Copper Wire Size	Conductor Screw Torque
25A	5.3 mm <sup>2</sup> (10 AWG)	4.0 Nm (35 lb in)
40A	8.4 mm <sup>2</sup> (8 AWG)	4.5 Nm (40 lb in)
60A	21.2 mm <sup>2</sup> (4 AWG)	5.1 Nm (45 lb in)
80A	26.7 mm <sup>2</sup> (3 AWG)	6.6 Nm (50 lb in)
100A	33.6 mm <sup>2</sup> (2 AWG)	6.6 Nm (50 lb in)
125A	42.1 mm <sup>2</sup> (1 AWG)	6.6 Nm (50 lb in)



### IMPORTANT

FOR U.S. INSTALLATIONS, READ THIS IMPORTANT NOTE

- Table 2 lists the mm<sup>2</sup> and AWG wire size for each circuit breaker size shown on the wiring diagrams. The minimum recommended circuit breaker sizes for each model and voltage application are listed on the wiring diagrams.
- Conductor sizes shall be no smaller than the 75°C wire size based on the ampacities given in Table 310–16 of the National Electrical Code® (NEC®), ANSI/NFPA 70-1999, and article 220. All circuit conductors, including the neutral conductor, must be the same size (ampacity) wire. Code may require a larger AWG size than shown in this table because of temperature, number of conductors in the conduit, or long service runs. Follow local code requirements.

## Bypass Module Installation



**NOTE** For installation and configuration of the Eaton bypass switch refer to the manual “Eaton Bypass Power Module (BPM) User’s Guide P-164000628” supplied with the switch or on the Eaton website <http://www.eaton.com/Eaton/index.htm>.

### UPS Connections



**NOTE 1** Refer to “Circuit Breaker Input Current Ratings” on page 16 for breaker, terminal block, and wire sizing.

**NOTE 2** Connection diagrams can be found on Figure 20 on page 24.



### CAUTION

To prevent electrical shock or damage to the equipment, verify that the Eaton 9PXM UPS is OFF before you remove the terminal covers. The circuit breaker or disconnect switch must also be OFF at the AC input service panel.

To install the UPS with an external bypass switch:

1. Mount the bypass switch within sight of the UPS. If you do not have an Eaton bypass switch or the fuse box or panel is out of sight, you must install a separate disconnect switch next to the UPS.
2. The bypass switch should be mounted securely to a sturdy surface. You may need to turn the cabinet 90 degrees (on its side) to enable operator access to the switch handle.
3. Remove the screws on the bypass switch front cover and remove the cover. Remove any packing material inside the bypass switch.
4. Remove the blank plate in the bottom of the bypass switch for AC Line Input, AC to UPS Input, AC from UPS Output, and AC to the UPS load.
5. Unscrew and remove the rear AC Input and Output upper terminal cover(s) of the UPS. See Figure 15.

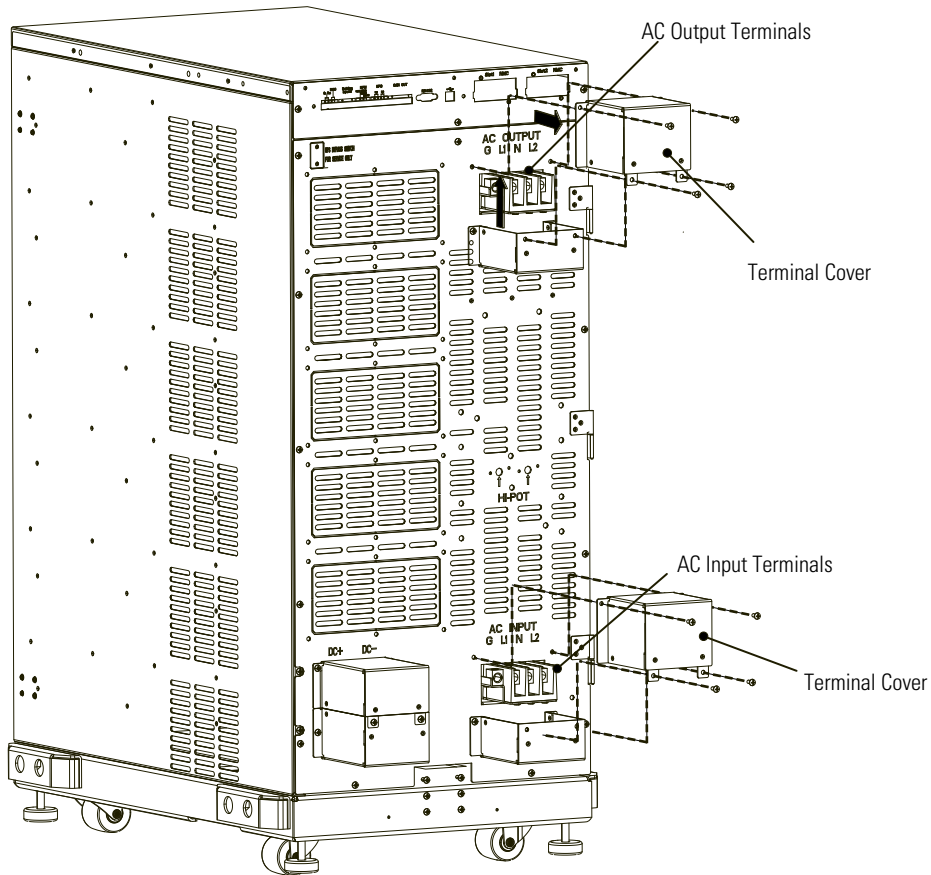

**Figure 15. UPS AC Power Terminal Access**

6. At the AC Input terminal, make sure to wire the UPS for the proper input voltage as shown in Figure 16.  
Split-phase power modules provide a 2-phase output which can be configured as output voltages: 110/110 for 220, 120/120 for 240, 120/120 for 208, or 127/127 for 220 Vac, as selected through the front panel display (see Chapter 6, “Initial Startup Parameters”).

---

**⚠ CAUTION**

---

Confirm that the UPS is wired for the proper input voltage as shown in Figure 16, and that the proper power modules will be installed to produce the desired output voltage.

---

**Split-Phase Power Modules**  
 (3-wire plus ground input) (2 PEN)  
 110/220, 120/208, 120/240, 127/220 Vac

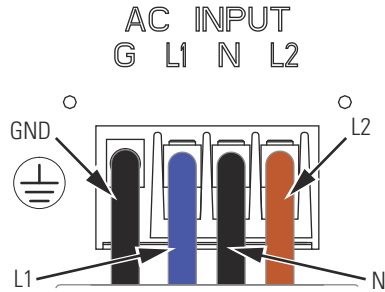

**Figure 16. UPS Input Wiring**



**NOTE**

UPS output circuits must be installed in separate conduit systems and not shared with other electrical circuits.

7. Make the UPS input and output connections to the terminal blocks on the rear panel (see Figure 17):

**NOTE**

UPS output circuits must be installed in separate conduit systems and not shared with other electrical circuits.

- a. Insert the L1, N and L2 cable ends into the applicable terminal slots on the terminal block.
- b. Insert the G (GND) cable end into the ground lug on the rear panel.
- c. Secure the cables by screwing down the lug screws.
- d. Torque the screws holding all input and output power conductors to the values specified in Table 2 on page 16.
- e. Reinstall the AC and DC terminal covers.

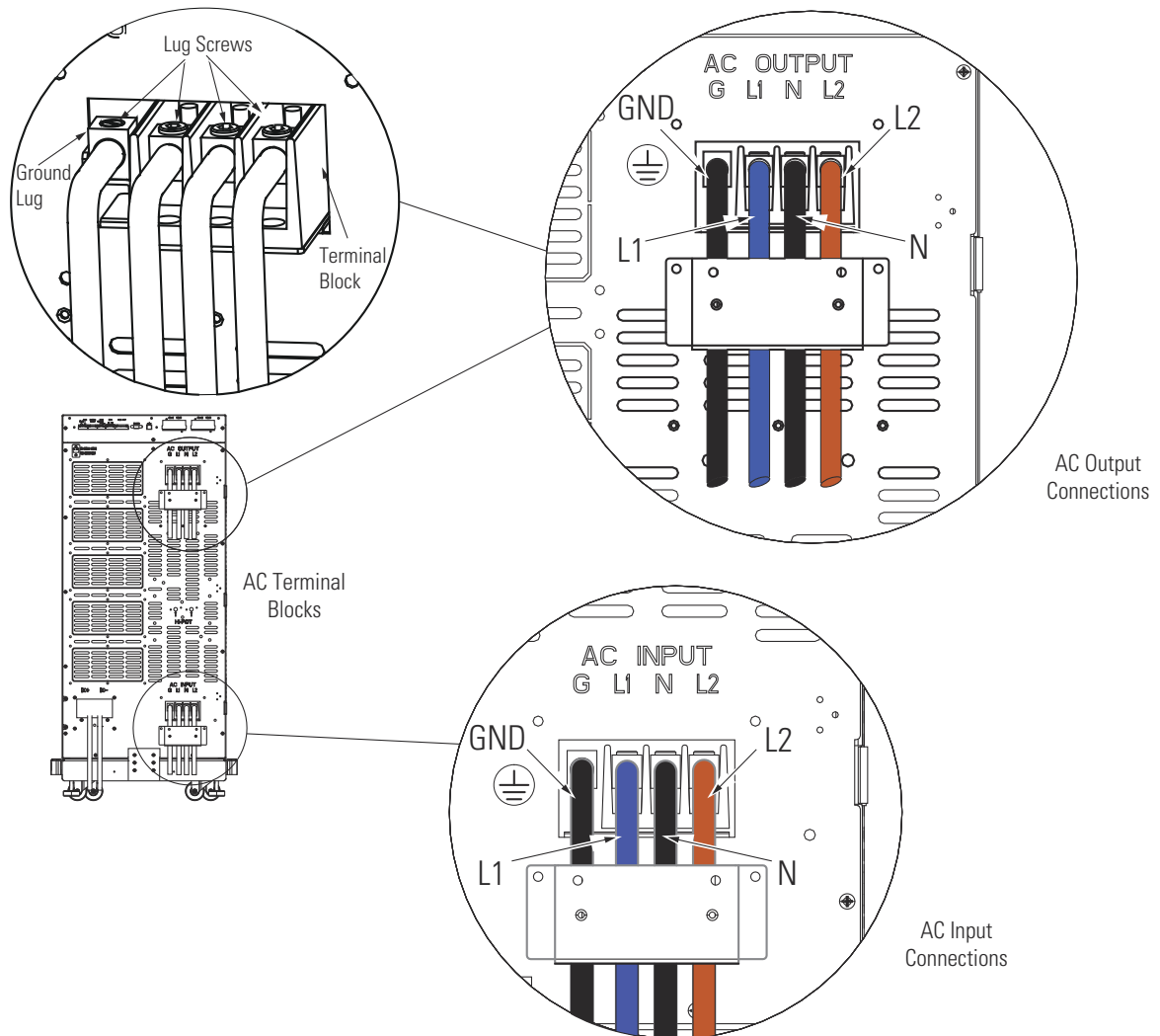

**Figure 17. UPS Input and Output Terminals**

8. Route the power cables to the BPM and install conduit adapters to the BPM bottom plate.
9. Use the label on the top of the BPM access cover and Figure 18, and make the connections to the BPM terminal blocks. Tighten all connections as specified in Table 2 on page 16. Use copper wire that is the appropriate size for the current draw.



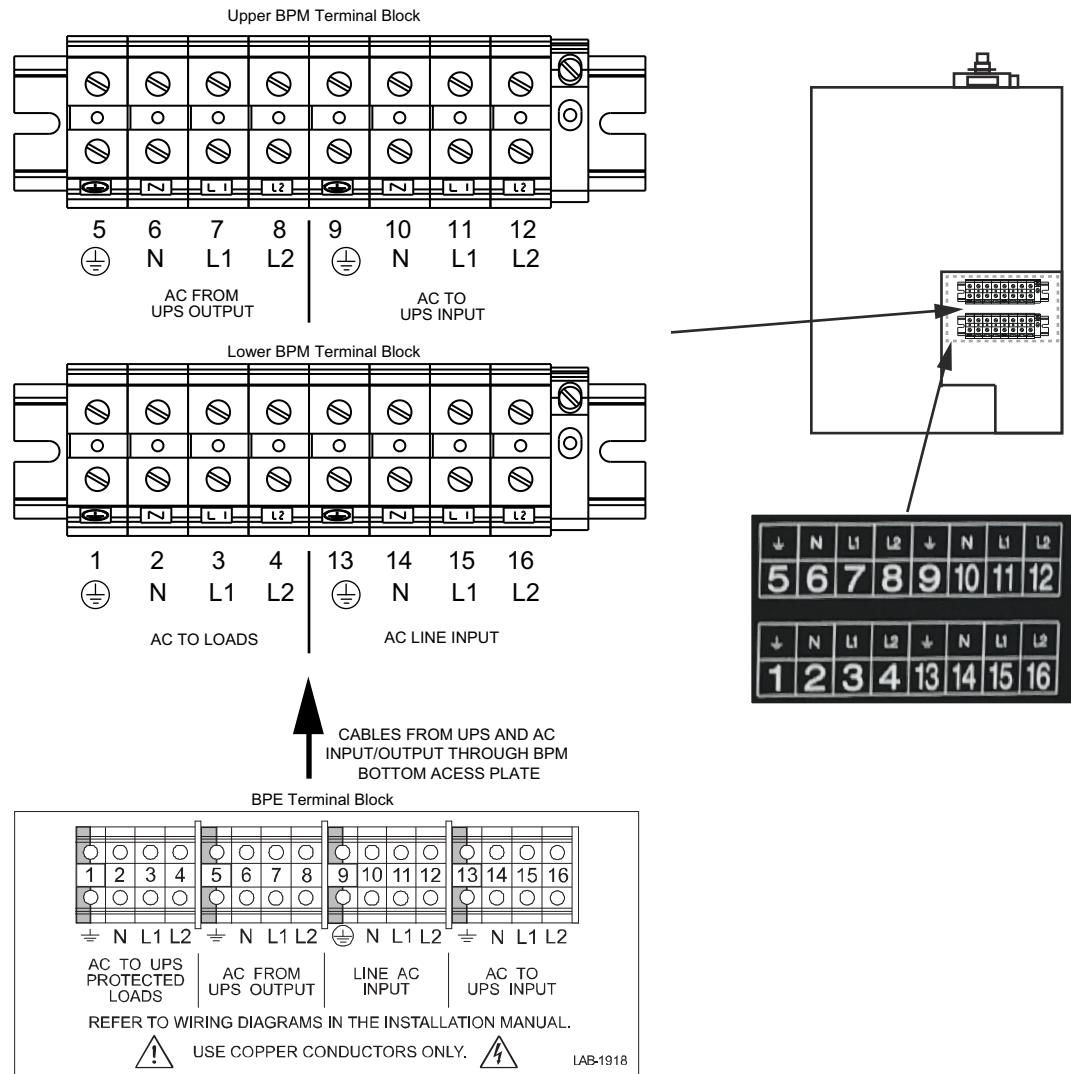

**Figure 18. Bypass Switch Wiring Label and Terminal Blocks**

10. After installing bypass switch wiring, torque the screws holding all input and output power conductors to the values specified in Table 2 on page 16.

### Input Signal Wire Routing

#### ⚠ CAUTION

The auxiliary contacts must be wired to the BPM from the UPS for proper functionality. These auxiliary contacts signal the UPS to go to Internal Bypass mode to provide a synchronized transfer. Failure to wire the auxiliary contacts can be dangerous and result in system failure.

1. Route the maintenance bypass signal wires in a conduit from the bypass module to the communication signal terminal (CN13) on the rear of the UPS (see Figure 19).
2. Place the signal wires through the proper conduit or grommet to the terminal block in the BPM

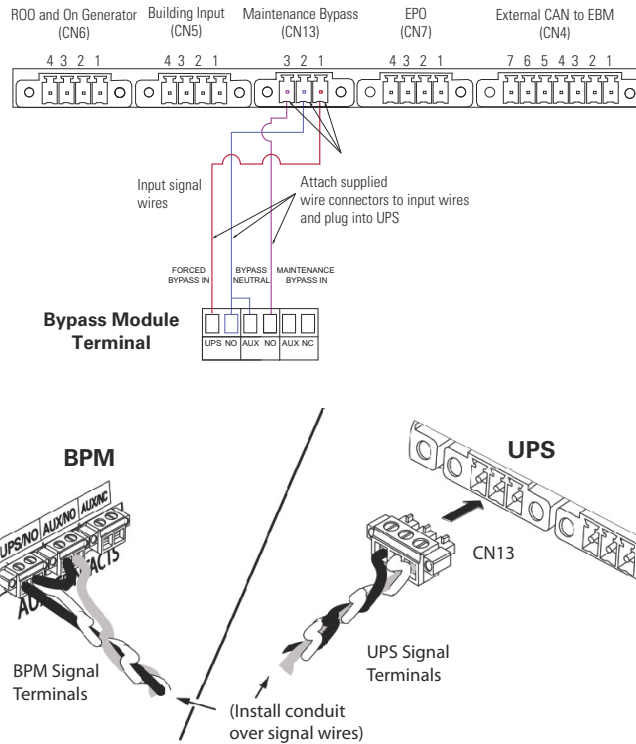

**Figure 19. UPS Input Control Signal Wiring for Maintenance Bypass**



**NOTE** Do not strain relieve EPO or external bypass wiring with the same cable tie used for Generator On wires.

**CAUTION**

EPO and external bypass circuits are not isolated from line voltage, and wiring must be installed according to local codes using conduit or suitable primary supply cables.

3. Attach the supplied cable connectors to the ends of the input wires.
4. Install the supplied wiring connectors to the UPS input control signal wires and connect to the terminals as shown in Figure 20. See Chapter 8, "UPS Communication Ports" from signal terminal identification.
5. When all connections have been made and checked, reinstall the bypass switch front cover using the original screws.
6. If floor anchor brackets were installed and not secured, install the floor bolts (see Chapter 2, "Anchor Bracket Installation" on page 11).
7. After electrical installation is complete, you must also set the output settings menu (See Figure 55 on page 64) for the required output voltage as shown in the wiring configuration drawings (See Figure 20 on page 24).

## System Wiring Diagram

Refer to the system wiring diagram for correct installation

The following notes are referenced by their number in the UPS with external bypass wiring diagram (see Figure 20 and Figure 21).

- 
- NOTE 1** **The customer must provide input overcurrent protection.** See NEC Section 240-21 or local requirements. See Table 1 on page 16 for circuit breaker ratings to size the protection device according to local code requirements.
- NOTE 2** The UPS bypass switch must be installed within sight of the UPS. To properly install, complete the voltage and phase check procedure in “UPS Startup” on page 50. The wires coming from the side of the switch must be connected as described in Step 1 on page 21.
- NOTE 3** **The customer must size the AC circuit conductors.** All AC circuit conductors, including the neutral conductor, must be the same size (ampacity), have the same rating (75°C) copper wire, and be sized according to the input circuit breaker. See Table 2 on page 16 for recommended wire sizes. The UPS input and output conductors must be run through separate conduits.
- NOTE 4** **The customer must provide output overcurrent protection.** See NEC Section 240-21 or local requirements. See Table 9 on page 87 for maximum output overcurrent protection device ratings.
- NOTE 5** See “Equipment Clearances” on page 9 for installation and service clearances before installing the UPS. Use flexible conduit on the UPS or the external battery cabinet if either must be moved.
- NOTE 6** External UPS battery cabinets are optional. See “Battery Cabinet Installation” on page 39 for installation instructions.
- NOTE 7** UPS output circuits shall be installed in dedicated conduit systems and not shared with other electrical circuits.
- NOTE 8** Use only Eaton-supplied power cables between the UPS and EBM(s) (PN:P-103003231).
- NOTE 9** CN3 and CN4 CAN cables ground separately to each cabinet chassis.
-

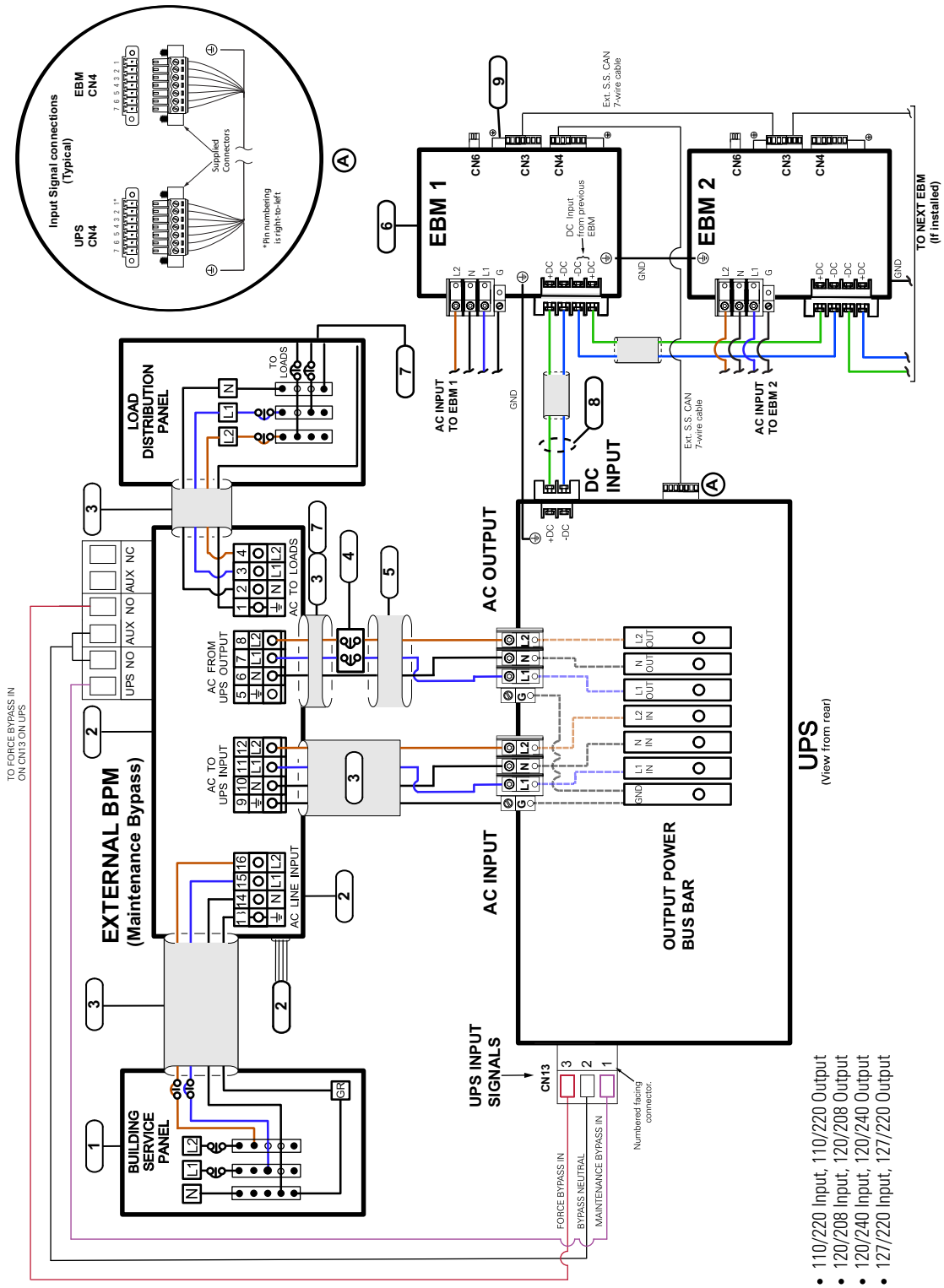

- 110/220 Input, 110/220 Output
- 120/208 Input, 120/208 Output
- 120/240 Input, 120/240 Output
- 127/220 Input, 127/220 Output

Figure 20. Wiring Diagram - UPS with External Bypass Switch (L1, L2, N)

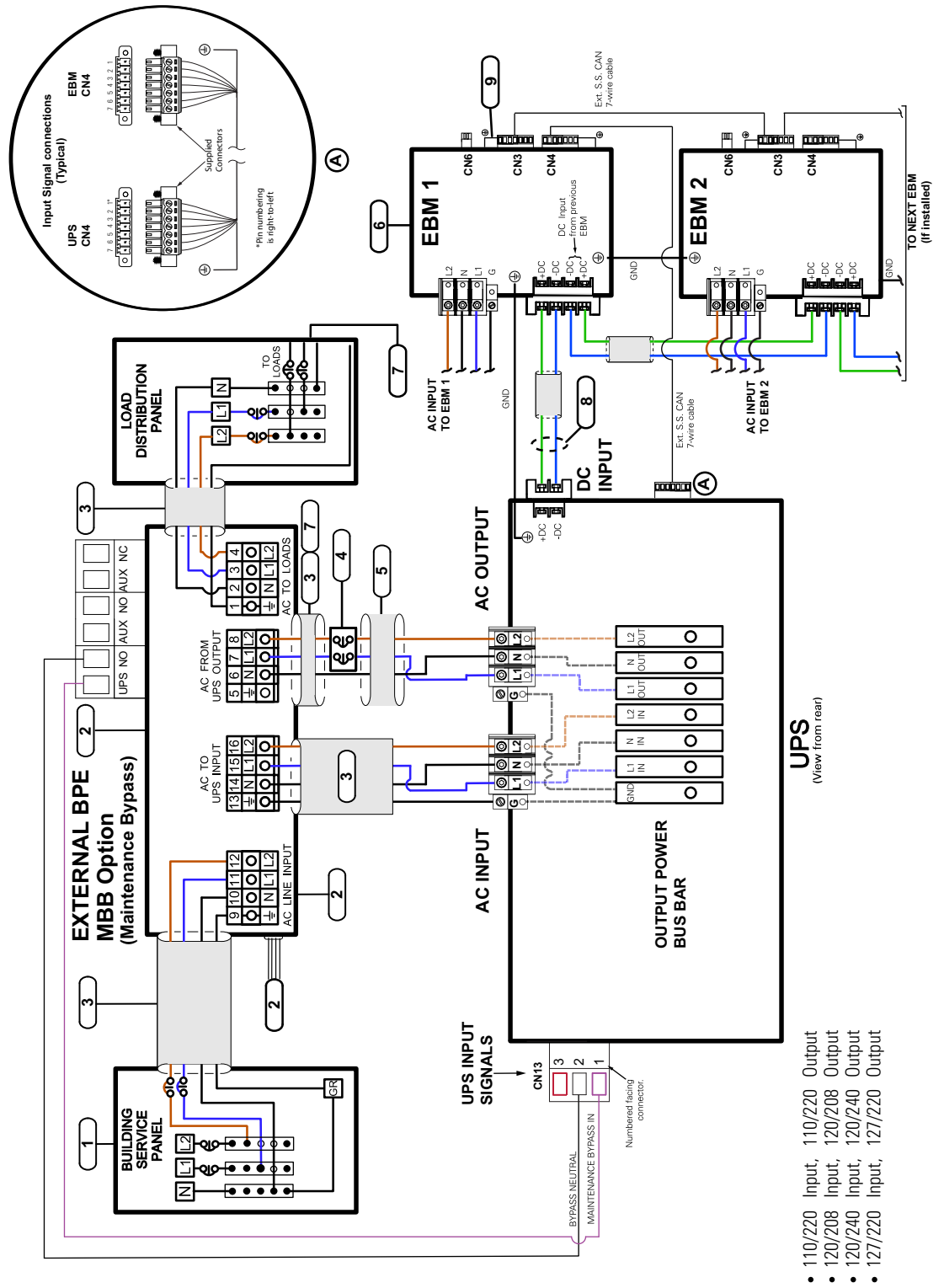

Figure 21. Wiring Diagram - UPS with External Bypass Switch (L1, L2, N) and MBB Option

## Bypass Overview

The BPM has three operating positions (see Table 1). Consider both the operating state of the UPS and the BPM when protecting your critical loads.

---

### CAUTION

---

Failure to understand the correct bypass sequence and position may cause the critical load to be dropped.

---

**NOTE 1** If the UPS remains in Manual Bypass mode and incoming AC power is lost, the load is automatically dropped. The UPS must be in Normal mode to provide battery backup power.

 **NOTE 2** In the UPS or LINE position, AC input power is still connected to the input terminals inside the UPS.

**NOTE 3** If you have any questions or problems with the bypass operation, call the Help Desk (see Chapter 11, “Service and Support” on page 94).

---

The BPM consists of a load position handle and a red button (see Figure 22).

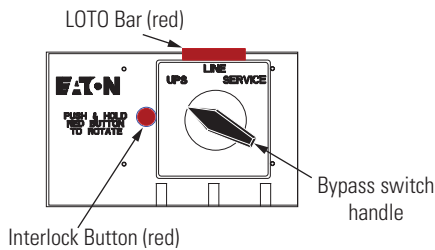

**Figure 22. Bypass Switch Positions**

The red button:

- Sends an electrical signal to the UPS to switch to the internal Bypass mode (if it is not already operating in that mode).
- Operates a mechanical interlock, to prevent the switch from being turned without first signaling the UPS.

You must press the red button before you can turn the load position handle.

When the red button is pressed, the UPS front panel displays “Manual Bypass.” To move the MBP switch handle from one position to another, the red button must be pressed **WHILE** the handle is being rotated. Otherwise, the switch will be damaged.

The bypass switch has three positions as described in Table 3.



**NOTE** In the UPS or LINE position, AC input power is still connected to the input terminals inside the UPS.

**Table 3. Bypass Switch Positions**

Switch Position	Description
LINE	When the switch is in the LINE position, utility power is directly connected to the critical load and the output of the UPS is disconnected. In this state the UPS remains powered, which is often beneficial for troubleshooting, obtaining logs, or updating firmware.
UPS	The normal operating state of the system occurs when the BPM switch is in the UPS position. Utility power is fed to the bypass, where power is then fed to the UPS. The UPS provides critical battery backup and power conditioning and power is then fed back to the bypass switch and then the critical load.
SERVICE	Like the LINE position, the SERVICE position connects the load directly to AC input power and disconnects UPS output; however, because SERVICE also disconnects AC input from the UPS, this is the appropriate position for UPS maintenance or repair. In the SERVICE position, the UPS can be completely removed from the system.

## Bypass Module Operation

### No Break Transfer from UPS Mode to Service Mode



It is critical that the following steps are followed to ensure correct and safe operation.

To turn the BPM to SERVICE:

1. Press and hold the red button and turn the switch to LINE (see Figure 23).



**NOTE** Pressing the red button sends the UPS into Internal Bypass mode. This allows the UPS output to synchronize with utility for safe, uninterrupted transfer.

The UPS is now in LINE mode. The critical load is fed directly from utility and the UPS remains energized from utility power. The UPS may be left in this mode while trying to troubleshoot, gather alarms from the UPS, or perform other preventative maintenance activities.

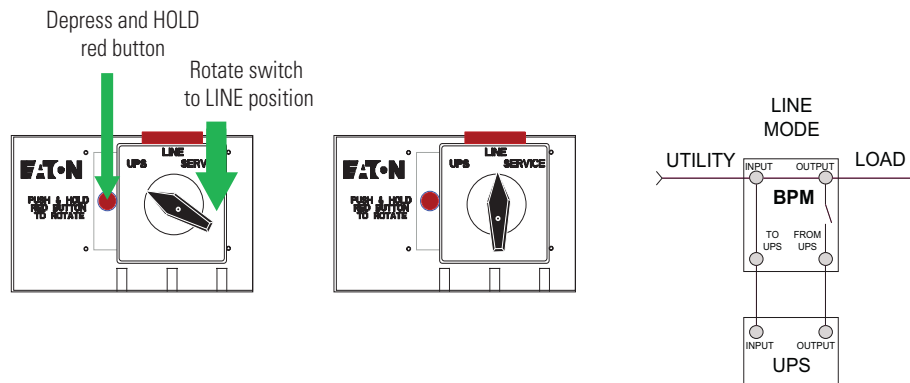

**Figure 23. Bypass From UPS to LINE**

- Turn the switch from LINE to SERVICE (see Figure 24). The critical load is fed directly from utility and the UPS is now completely disconnected from AC power. Ensure that the UPS is off and the terminals are completely de-energized before performing any maintenance on the UPS.

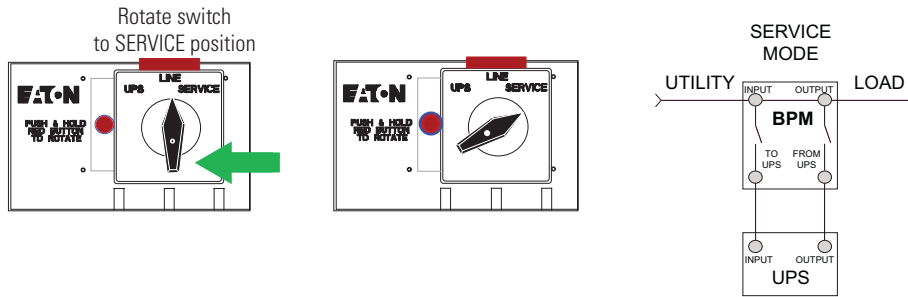
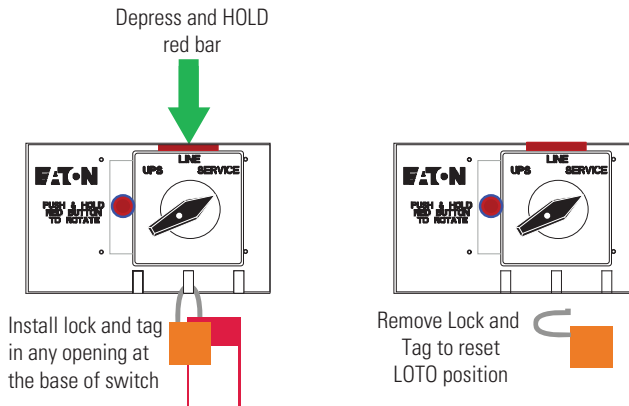

**Figure 24. Bypass From LINE to SERVICE**

### Lock-out/Tag-out

The BPM comes with a Lock-out/Tag-out (LOTO) feature to keep the BPM bypass switch locked in SERVICE mode while qualified service personnel works on the UPS. To use the LOTO feature:

- Press and hold the red bar (see Figure 25).



**Figure 25. LOTO Feature**

- Install a lock and tag in any opening at the base of the switch according to LOTO procedures.
- Remove the lock and tag to reset the LOTO position.

### No Break Transfer from Service Bypass to UPS Mode

After the system has been placed into SERVICE mode, it must be returned to UPS state to resume normal operation.

---

**⚠ WARNING**

---

It is critical that the following steps are followed to ensure correct and safe operation.

---

To turn the BPM to UPS mode:



1. Turn the switch from SERVICE to LINE (see Figure 26).

The UPS is now in LINE mode and is energized. It is often best practice to check the UPS status and configure settings in this mode before transitioning to UPS mode. Simply check the status of the UPS through the front LCD menu to ensure the UPS is prepared for use.

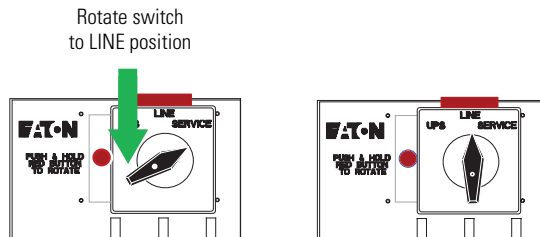

**Figure 26. From SERVICE to LINE**

2. To transition the UPS from LINE to UPS, press and hold the red button and turn the switch to UPS (see Figure 27).

**NOTE 1** Pressing the red button sends the UPS into Internal Bypass mode. This allows the UPS output to synchronize with utility for safe, uninterrupted transfer.



**NOTE 2** In UPS mode, the UPS resets from Internal Bypass to UPS Normal mode (online mode). This transition may take as long as 60 seconds.

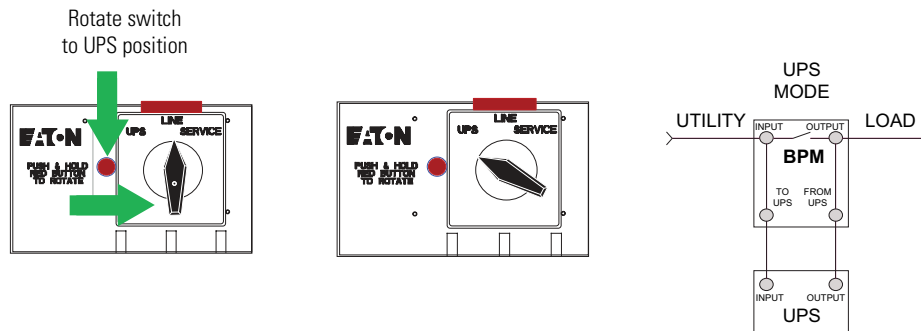

**Figure 27. From LINE to UPS**







3. Once the switch is in UPS mode and the UPS is in Normal mode (online mode), the system is in normal operation and prepared to provide uninterrupted power to the critical load.

After turning the load position handle to the UPS position and releasing the red button, if the Eaton 9PXM UPS remains in Bypass mode, return the UPS to Normal mode using the following procedure for proper operation:

**NOTE 1** If the UPS remains in Manual Bypass mode and incoming AC power is lost, the load is automatically dropped. The UPS must be in Normal mode to provide battery backup power.



**NOTE 2** If you have any questions or problems with the bypass operation, call the **Help Desk** at one of the telephone numbers on page 94 and ask for a UPS technical representative.

- a. Press the  button on the front panel display. The main menu screen appears (see Figure 53 on page 62).
- b. Press the  button to select Control.
- c. Press the  button. Control menu displays.
- d. Press the  button to select Go back normal.
- e. Press the  button to select Yes and press  to return to normal (UPS) mode.
- f. Press ESC twice to return to the Status Menu. The UPS is now in Normal mode.



**NOTE** To disconnect AC input power during maintenance or service, turn the bypass switch to the SERVICE position.

Table 4 shows the bypass switch models available for the Eaton 9PXM UPS.

**Table 4. Bypass Switch Specifications**

Model	Height	Width	Depth	Weight
	(A)	(B)	(C)	
BPM125XX	130 mm (21.0")	440 mm (14.0")	663 mm (6.8")	17 kg (38 lb)

## Chapter 4 UPS Electrical Installation

### **WARNING**

Risk of electrical shock. Only qualified service personnel (such as a licensed electrician) should perform the electrical installation in this section.

If a bypass switch is not used, the UPS input may be hardwired through conduit to a main power source circuit breaker, and the UPS output may either be hardwired to a circuit breaker in a distribution panel (as shown in Figure 28) or supplied to loads through optional receptacles on the back of the UPS. Without a bypass switch, power to the load cannot be maintained if the UPS is taken completely offline.

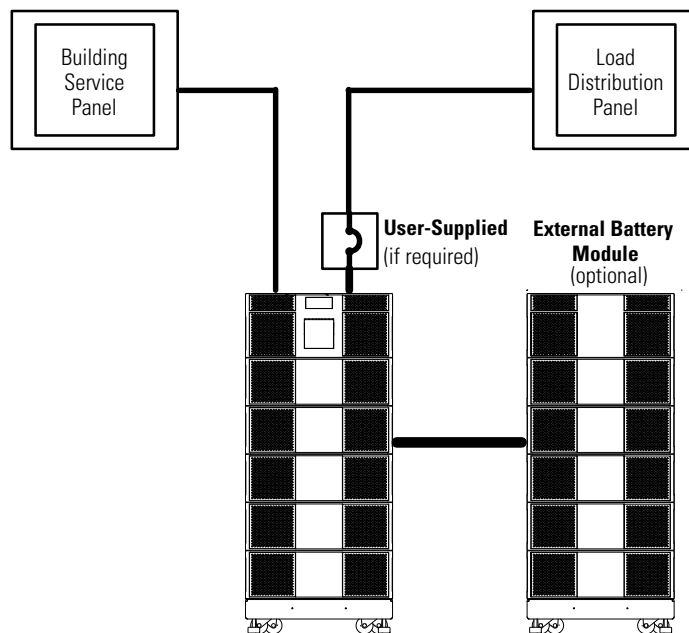

**Figure 28. Typical Installation without a Bypass Switch**

### Input Current Ratings

Table 5 contains the required circuit breaker ratings for hardwired installations.

**Table 5. Required Input Circuit Breaker Sizes (120/208 Vac or 120/240 Vac, 60 Hz)**

UPS Capacity	Input Circuit Breaker Rating
4 kVA	25A
8 kVA	50A
12 kVA	75A
16 kVA	100A
20 kVA	125A

---

**NOTE**  To accommodate the feature of easy system expendability, it is recommended that initial installation of the Eaton 9PXM UPS contains wiring to support the maximum capacity of the UPS cabinet: 20 kVA for 8- and 12-slot cabinets.

---

See Table 6 for recommended conductor sizes to wire the input circuit breakers.

**Table 6. Recommended Wire Sizes**

Input Circuit Breaker Size	75°C Copper Wire Size	Conductor Screw Torque
25A	5.3 mm <sup>2</sup> (10 AWG)	4.0 Nm (35 lb in)
40A	8.4 mm <sup>2</sup> (8 AWG)	4.5 Nm (40 lb in)
60A	21.2 mm <sup>2</sup> (4 AWG)	5.1 Nm (45 lb in)
80A	26.7 mm <sup>2</sup> (3 AWG)	6.6 Nm (50 lb in)
100A	33.6 mm <sup>2</sup> (2 AWG)	6.6 Nm (50 lb in)
125A	42.1 mm <sup>2</sup> (1 AWG)	6.6 Nm (50 lb in)



**IMPORTANT**

**FOR U.S. INSTALLATIONS, READ THIS IMPORTANT NOTE**

- Table 6 lists the mm<sup>2</sup> and AWG wire size for each circuit breaker size shown on the wiring diagrams. The minimum recommended circuit breaker sizes for each model and voltage application are listed on the wiring diagrams.
- Conductor sizes shall be no smaller than the 75°C wire size based on the ampacities given in Table 310–16 of the National Electrical Code (NEC), ANSI/NFPA 70-1999, and article 220. All circuit conductors, including the neutral conductor, must be the same size (ampacity) wire. Code may require a larger AWG size than shown in this table because of temperature, number of conductors in the conduit, or long service runs. Follow local code requirements.

**UPS Electrical Installation**



**WARNING**

Only qualified service personnel (such as a licensed electrician) should perform the electrical installation. Risk of electrical shock.



**CAUTION**

To prevent electrical shock or damage to the equipment, verify that the Eaton 9PXM UPS is OFF before you remove the terminal covers. The circuit breaker or disconnect switch must also be OFF at the AC input service panel.

To install the UPS without an external bypass switch:

**NOTE** The AC input and output covers and terminal blocks are identical.

1. Unscrew and remove the rear AC terminal upper covers (See Figure 29).

The AC input terminal block is located on the lower right side and the AC output on the upper right side of the UPS rear panel.

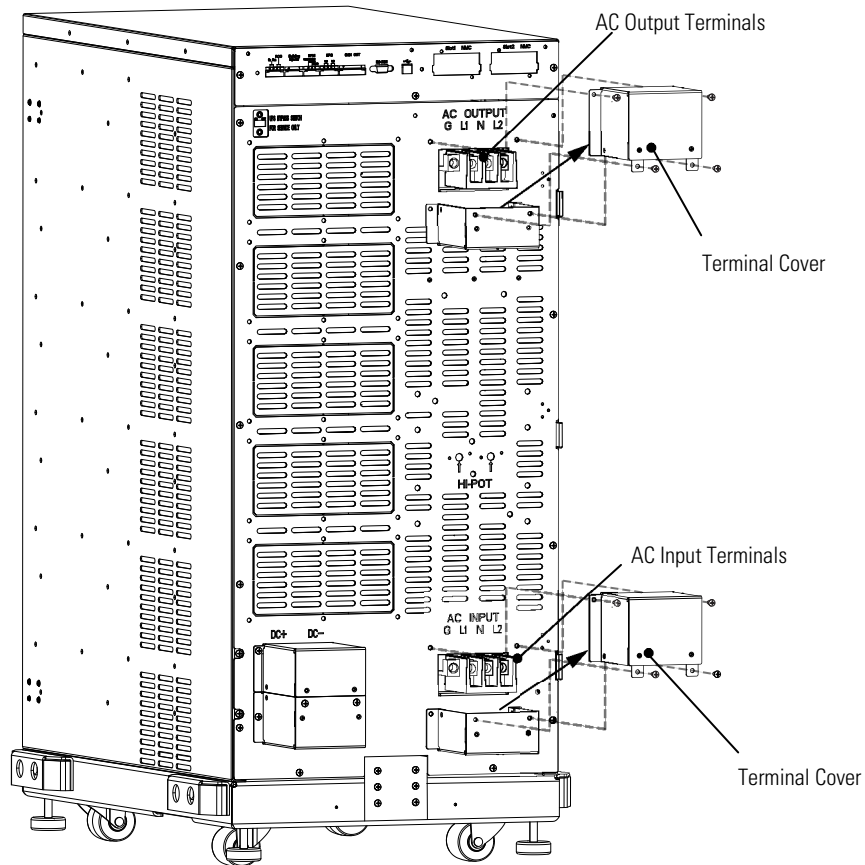

**Figure 29. UPS Power Terminals**

2. At the AC Input terminal, make sure to wire the UPS for the proper input voltage as shown in Figure 30.

Split-phase power modules provide a 2-phase output which can be configured as output voltages: 110/110 for 220, 120/120 for 240, 120/120 for 208, or 127/127 for 220 Vac, as selected through the front panel display (see Chapter 6, "Initial Startup Parameters").

---

**⚠ CAUTION**

---

Confirm that the UPS is wired for the proper input voltage as shown in Figure 30, and that the proper power modules will be installed to produce the desired output voltage.

---

**Split-Phase Power Modules**  
 (3-wire plus ground input) (2 PEN)  
 110/220, 120/208, 120/240, 127/220 Vac

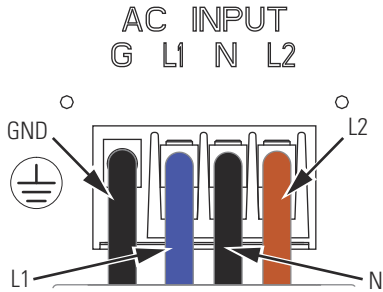

**Figure 30. UPS Input Wiring**

**NOTE** UPS output circuits must be installed in separate conduit systems and not shared with other electrical circuits.

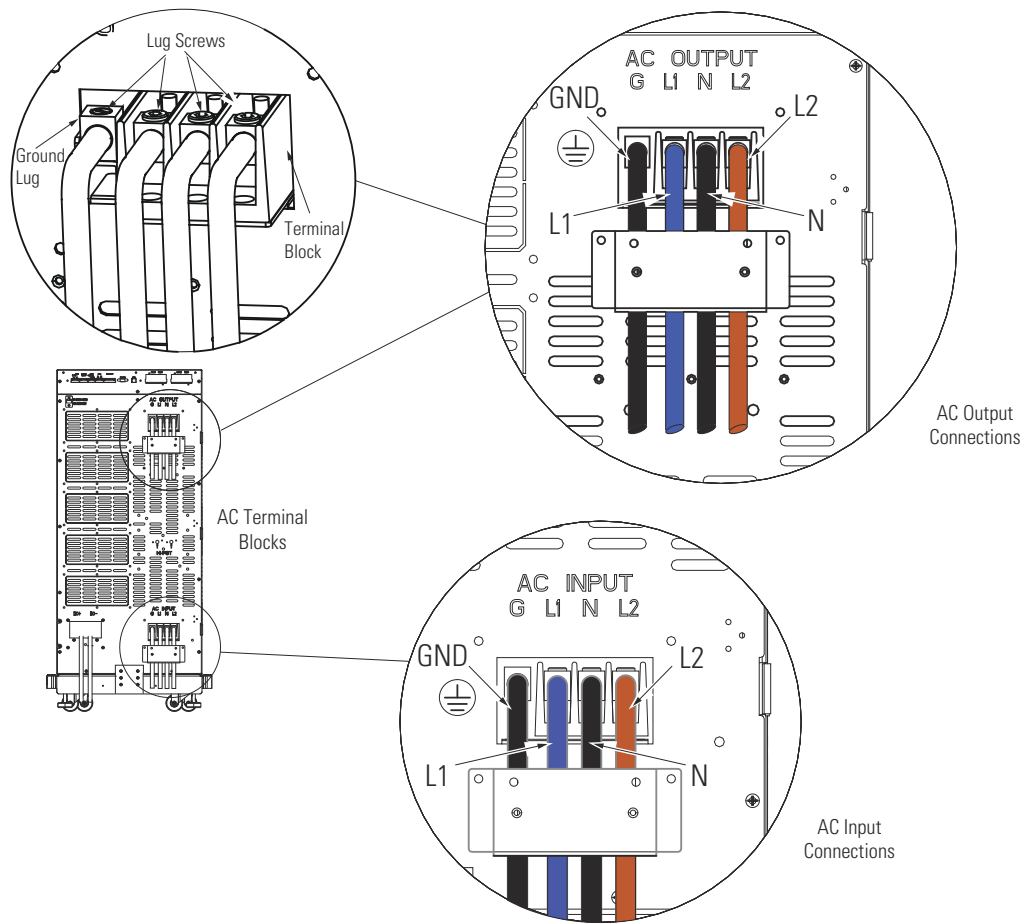

**Figure 31. UPS Input and Output Terminal Connections**

3. Make the UPS input and output connections to the terminal blocks on the rear panel (see Figure 31):

**NOTE** UPS output circuits must be installed in separate conduit systems and not shared with other electrical circuits.

- a. Insert the L1, N and L2 cable ends into the applicable terminal slots on the terminal block.
  - b. Insert the G (GND) cable end into the ground lug on the rear panel.
  - c. Secure the cables by screwing down the lug screws.
4. Route and connect the AC input cables to the building service panel and the AC output cables to the load distribution panel as shown in Figure 32.
  5. Torque the screws holding all input and output power conductors to the values specified in Table 6 on page 32.
  6. Reinstall the AC and DC terminal covers as applicable.
  7. Install the supplied wiring connectors to the UPS input control signal wires and connect to the terminals as shown in Figure 32. See Chapter 8, "UPS Communication Ports" from signal terminal identification.
  8. When all connections have been made and checked, reinstall the UPS terminal covers using the original screws.
  9. If floor anchor brackets were installed and not secured, install the floor bolts (see Chapter 2, "Anchor Bracket Installation" on page 11).
  10. After electrical installation is complete, you must also set the output settings menu at UPS startup (See Chapter 6, "UPS Startup" on page 47) for the required output voltage as shown in the wiring configuration drawings (See Figure 32 on page 37).

## System Wiring Diagram

Refer to the system wiring diagram for correct installation

The following notes are referenced by their number in the UPS with no external bypass wiring diagram (See Figure 32).

---

**NOTE 1** **The customer must provide input overcurrent protection.** See NEC Section 240-21 or local requirements. See Table 5 on page 31 for circuit breaker ratings to size the protection device according to local code requirements.

**NOTE 2** **The customer must size the AC circuit conductors.** All AC circuit conductors, including the neutral conductor, must be the same size (ampacity), have the same rating (75°C) copper wire, and be sized according to the input circuit breaker. See Table 6 on page 32 for recommended wire sizes. The UPS input and output conductors must be run through separate conduits.

**NOTE 3** **The customer must provide output overcurrent protection.** See NEC Section 240-21 or local requirements. See Table 9 on page 87 for maximum output overcurrent protection device ratings.



**NOTE 4** See “Equipment Clearances” on page 9 for installation and service clearances before installing the UPS. Use flexible conduit on the UPS or the external battery cabinet if either must be moved.

**NOTE 5** External UPS battery cabinets are optional. See “Battery Cabinet Installation” on page 39 for installation instructions.

**NOTE 6** UPS output circuits shall be installed in dedicated conduit systems and not shared with other electrical circuits.

**NOTE 7** Use only Eaton-supplied power cables between the UPS and EBM (PN:P-103003231).

**NOTE 8** CN3 and CN4 CAN cables ground separately to each cabinet chassis.

---



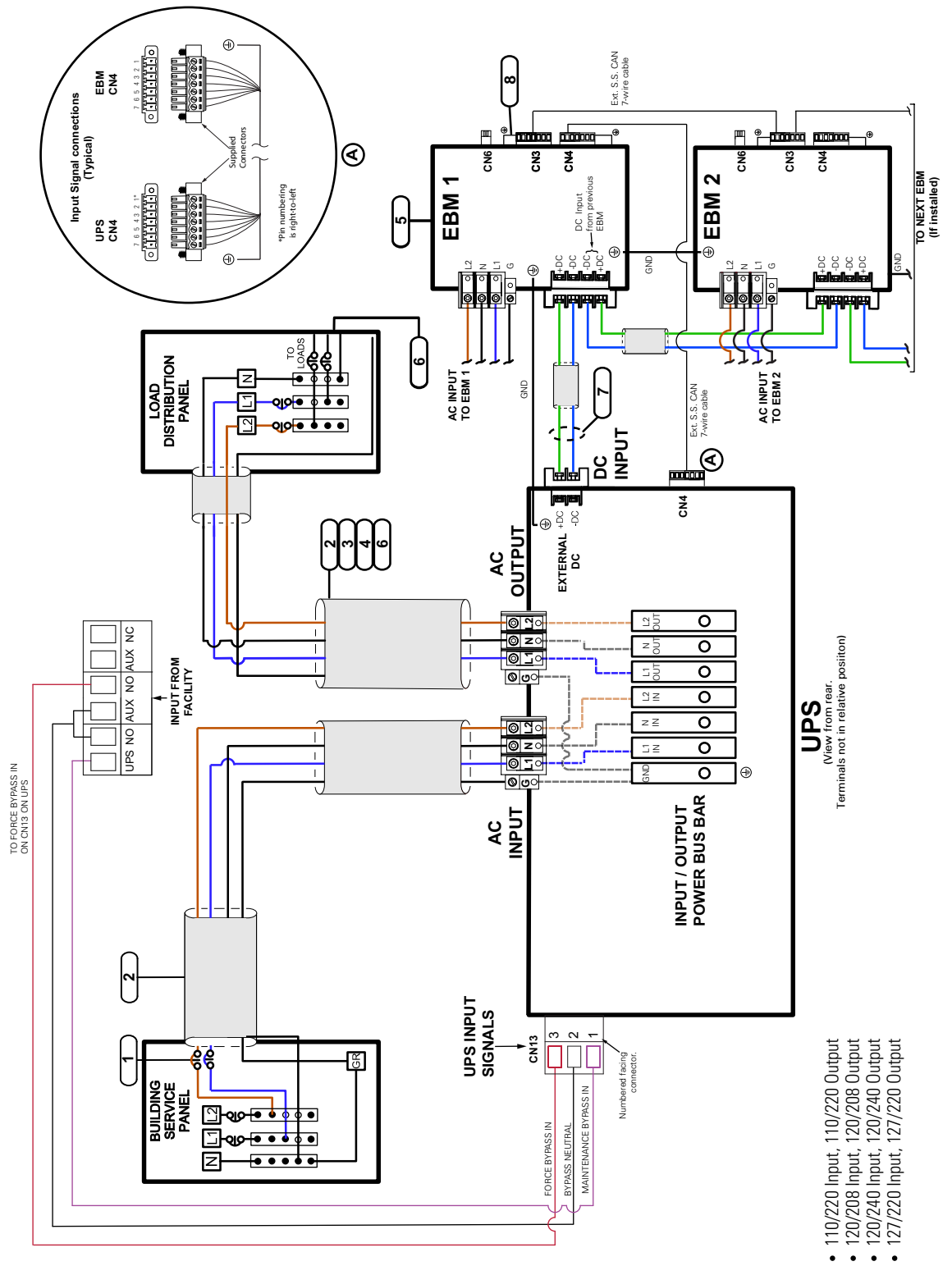

Figure 32. Wiring Diagram - UPS with No External Bypass (L1, L2, N)

This page intentionally left blank.

## Chapter 5 Battery Cabinet Installation

If you are not installing optional external battery modules (EBM), continue to “UPS Startup” on page 47.

---

### **WARNING**

---

Only qualified service personnel (such as a licensed electrician) should perform the battery cabinet installation. Risk of electrical shock.

---

---

### **CAUTION**

---

- Before connecting an external battery cabinet to the UPS cabinet or to another external battery cabinet, verify that all AC input power is removed from the UPS. Open the input service circuit breaker or turn the external bypass switch to the SERVICE position.
  - Remove all battery modules in the UPS cabinet and/or battery cabinet to ensure DC voltage is removed from the internal DC buses (see Chapter 2, “Securing the UPS in the Rack” on page 14).
  - In the UPS cabinet, the proper location of cabinet-to-cabinet DC wiring is on the lower left of the rear panel.
  - In the external battery cabinets other than the P-103002494, this wiring installs into the rear panel where the DC emergency disconnect switch is located.
  - For the P-103002494 external battery cabinet, this connection is on the lower left of the rear panel.
  - Do not connect the EBM AC input to the UPS output
  - Note that the front lower left slot of P-103002494 is solely for AC input for charger modules.
- 

**NOTE 1** The P-103002494 is the only external battery cabinet that can accommodate a super charger module.



**NOTE 2** Only the lower left slot (facing you) of the P-103002494 can accommodate a super charger module. If the slot is not used for super charger module, the remaining slot may be used for a battery module.

**NOTE 3** The P-103002494 12-slot external battery cabinet must be wired for input power from the utility AC power supply.

---

### Prepare the EBM cabinet:

---

**NOTE 1** The external battery cabinets are the same dimensions as the UPS cabinets. Refer to Chapter 2, “UPS Setup” on page 9 for unpacking and cabinet setup.



**NOTE 2** If you are installing multiple EBM(s) upstream to the UPS, repeat the setup as described in this section.

---

1. Open the carton containing the external battery cabinet cable assembly and position it in the desired location next to the UPS.
2. If you are rack-mounting the EBM cabinet, refer to the UPS rack-mount installation procedure (see Chapter 2, “Rack-Mount Installation” on page 12). If not, proceed to the next step.
3. Install the anchor brackets to the floor if applicable (see Chapter 2, “Anchor Bracket Installation”

**CAUTION**

Make sure all AC power is removed from the UPS. Observe all electrical safety precautions.

4. Push in the EBM DC emergency disconnect switch on the rear EBM panel and turn the switch lockout key (see Figure 33).
5. Remove the EBM terminal covers on the UPS and EBM.



**NOTE** Refer to step 3 in “Connecting the EBM(s) to the UPS” on page 41 to determine whether removing the AC terminal cover on the EBM is required.

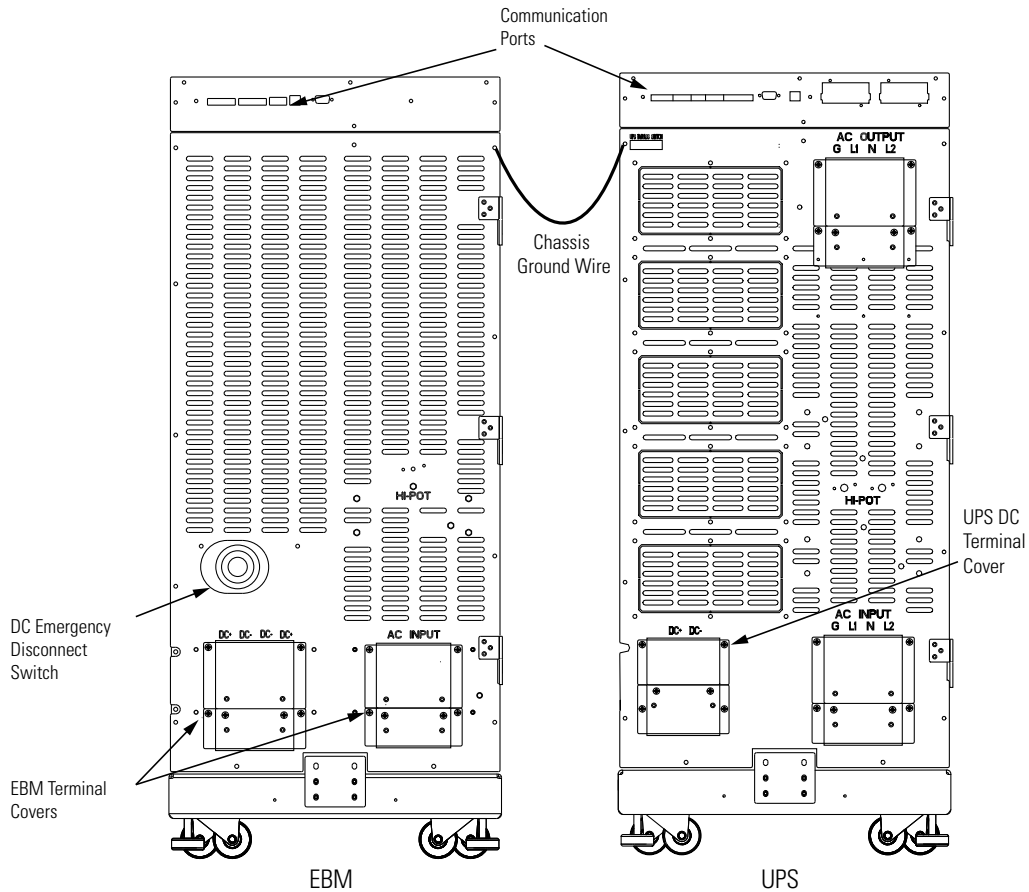

**Figure 33. UPS Connections**

### Connecting the EBM(s) to the UPS

1. Route the EBM DC input/output and AC input cables to the terminal blocks as shown in Figure 34.

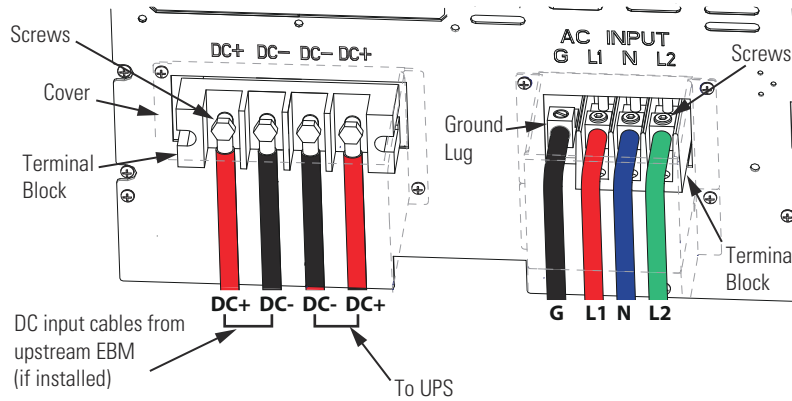

**Figure 34. Battery Cable Assembly Installation.**

**NOTE** Torque the screws holding all input and output power conductors to the values specified in Table 6 on page 32

2. Connect the EBM DC cables to the applicable terminals by removing and reinstalling the screws onto the terminal blocks.

**NOTE** DC input cables only required if EBM(s) are installed upstream.

3. Connect the AC cables to the applicable terminals by inserting the ends into the AC terminal block and tighten the screws depending on the EBM configuration option as follows:

#### Option #1

**120V/208V or 120V/240V Split-Phase Input** = Super Charger Capable, UPS Communication Capable and Extended Run-Time Battery Support (see Figure 35).

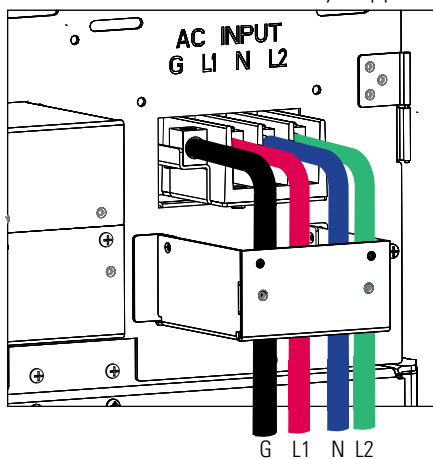
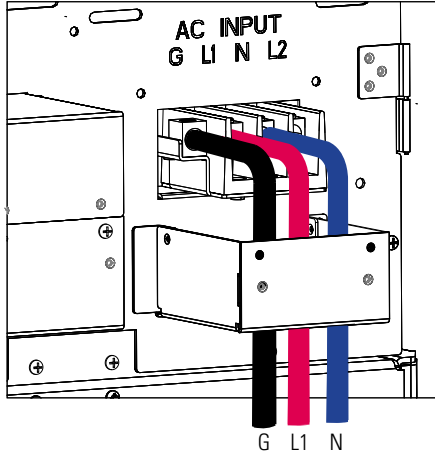

**Figure 35. Split-Phase Input**

## Option #2

**120VAC Single Phase Input** = UPS Communication Capable and Extended Run-Time Battery Support (see Figure 36).

**NOTE** 5-15P included in accessory kit. Only to be used with this wiring option.



**Figure 36. Single Phase Input**

## Option #3

**No AC Input** = Extended Run-Time Battery Support (see Figure 37).

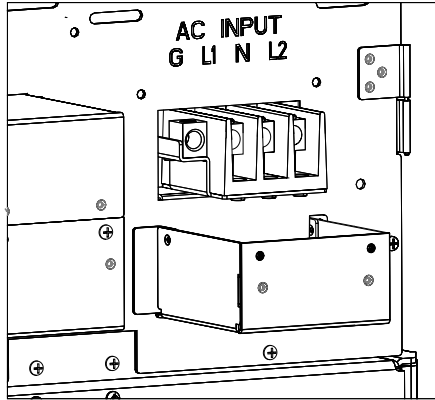

**Figure 37. No AC Input**

4. Connect the AC ground cable into the ground lug and tighten the lug screw.
5. Connect the EBM AC input cables to the AC supply and the DC output cables to the UPS (see Figure 37).
6. Reinstall the AC and DC terminal covers.

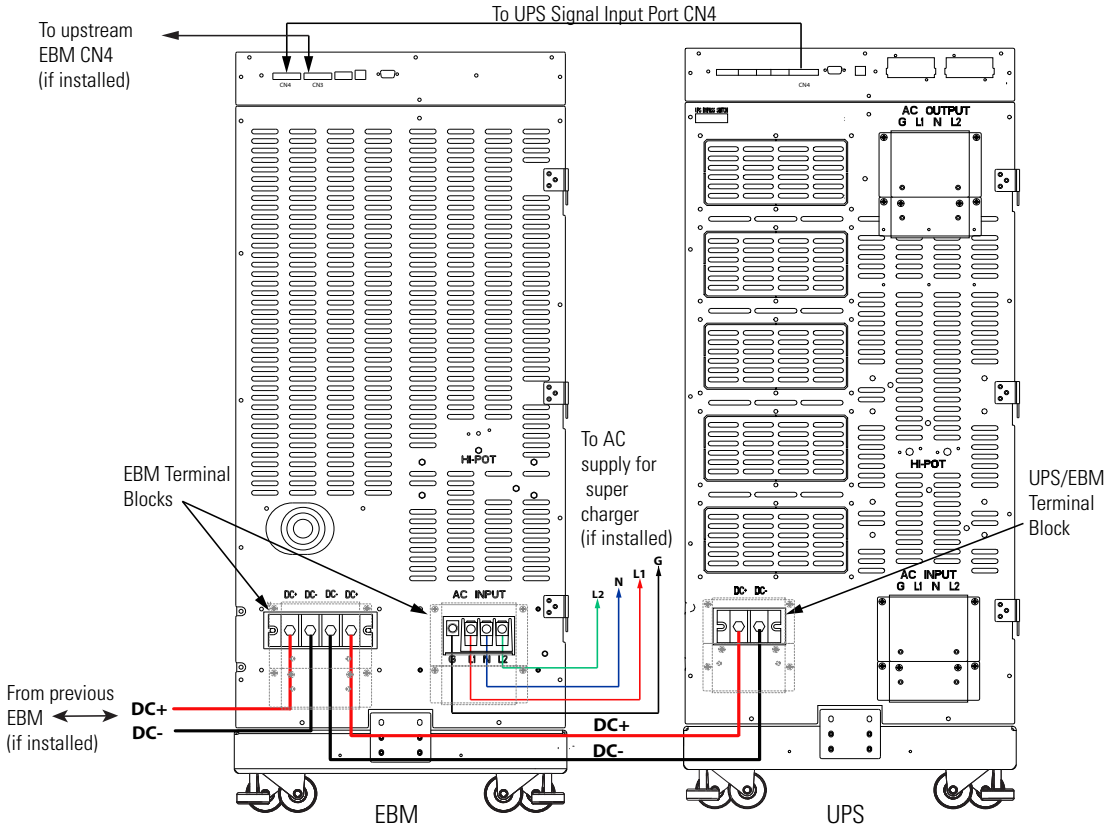

**Figure 38. EBM to UPS Connections**

7. On the upper rear panels, connect the input signal cables from the EBM CN4 to the UPS input signal port CCN4 using the supplied cables with (see Figure 38).
8. If additional battery cabinets are to be connected to the first, in a daisy-chain configuration, connect each EBM with signal cables from CN3 to CN3 (see Figure 39).

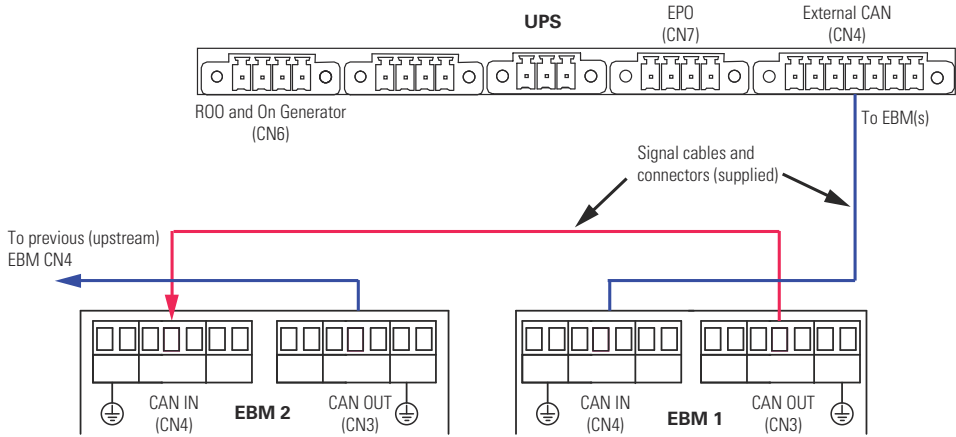

**Figure 39. UPS Input Control Signal Wiring (for External Controls)**

9. Connect the CAN cable ground wires to the EBM chassis (see Figure 40).

---

**NOTE**  Connect each CAN ground wires to separate screws on the chassis. BM(s) are installed upstream.

---

10. If an additional battery cabinet is to be connected to the first, in a daisy-chain configuration, use another external battery cabinet cable assembly for the connections between the battery cabinets and connect as per Step 1 to Step 9 above.
11. Install CAN and chassis ground wires between EBM to EBM and the EBM to UPS chassis (see Figure 40 and Figure 41).

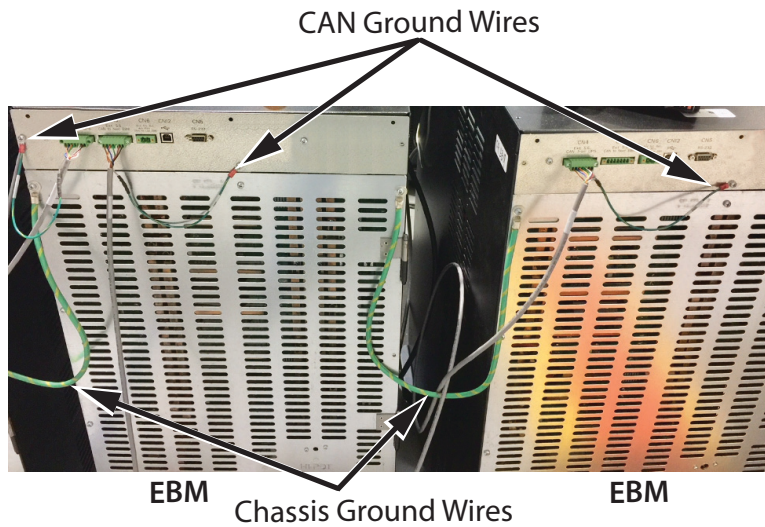

**Figure 40. CAN and Chassis Ground Wires EBM to EBM**

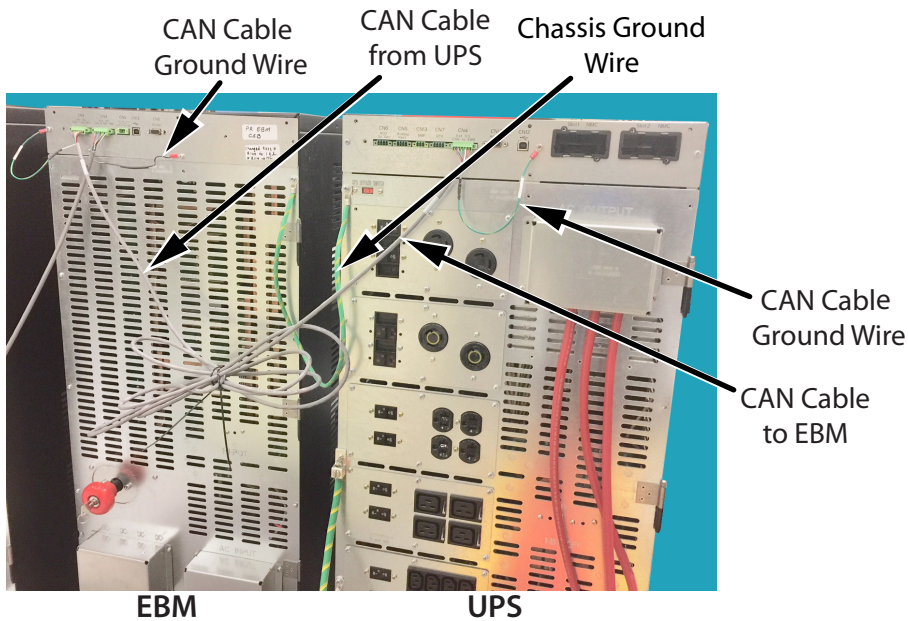

**Figure 41. CAN and Chassis Ground Wires EBM to UPS**



12. Close the DC emergency disconnect switch button on the back of each EBM. Insert the switch key supplied with the cabinet into the button and turn clockwise 1/2-turn. Pull the button OUT to close the switch and reconnect DC power. Turn the key back counter-clockwise, and remove the key (see Figure 42)

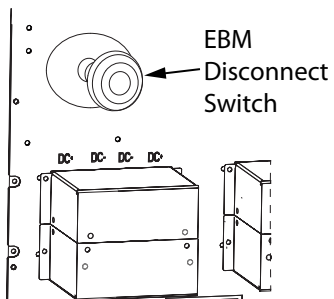

**Figure 42. EBM Emergency Disconnect Switch**

This page intentionally left blank.

## Chapter 6 UPS Startup

This section provides step-by-step instructions for starting your Eaton 9PXM system. Follow these procedures closely to avoid potential damage to your equipment or the UPS and to protect yourself and others from hazardous operating conditions.

---

### CAUTION

---

- This UPS contains its own energy source (batteries). The output receptacles may carry hazardous voltage even when the UPS is not connected to an AC supply. When AC input voltage is present, the Eaton 9PXM system can provide output voltage even though its batteries are disconnected. To confirm that there is no UPS output voltage, always disconnect all of the AC input sources and unplug all two battery modules per slot of internal batteries; if the UPS has one or more separate battery cabinets (EBMs), open (push in) the DC emergency disconnect switch button on each battery cabinet or unplug all battery two battery modules per slot in each battery cabinet.
  - To reduce the risk of fire or electric shock, install this UPS in a temperature and humidity controlled, indoor environment, free of conductive contaminants. Ambient temperature must not exceed 40°C (104°F). Do not operate near water or excessive humidity (95% maximum).
  - For optimum battery life, ambient temperature should not exceed 25°C (77°F). Battery life is substantially reduced if ambient temperature is higher.
  - Do NOT lower the casters or attempt to move the cabinet with the power or battery modules installed.
- 

### Power Module and Battery Module Installation

The UPS power modules (UPMs) are installed in the left hand slots of the UPS facing the user. The two battery modules are installed in the left or right hand slots. Removal of the power modules and battery modules is the reverse of these procedures.

Install the UPMs into the Eaton 9PXM cabinet: as follows:

1. Remove the front cover(s) of the cabinet. The covers have magnetic latches on the left and right sides that hold them in place.

---

**NOTE 1** Place battery modules beside all power modules in the UPS cabinet. Two battery modules installed on top of each other are required for each battery slot and can be removed separately.

**NOTE 2** If you are installing a super charger module in the UPS, the super charger can be installed in any of the left side slots. In the EBM, the super charger can only be installed in the lower left side slot.

 **NOTE 3** Do NOT install more than six power and/or optional super charger modules in the system.

**NOTE 4** The installation procedures of the optional battery cabinet (EBM) battery, power and super charger modules are identical to the UPS units.

**NOTE 5** Battery modules are shipped fully charged. It is recommended to charge the batteries for 48 hrs. after installation to ensure full power. If AC power fails before full battery charge, backup will be available but for a reduced duration.

---

2. Insert the power modules into the left hand slots of the cabinet. Push each module firmly until it contacts the connections in the rear of the slot.

3. Tighten the captive screw (see Figure 43).
4. To install the battery modules (see Figure 43):
  - Slide the lower battery module fully into the slot until it contacts the connections in the rear of the slot.
  - Repeat the procedure with the upper battery module.
  - Install the retaining bracket and tighten the captive screw with a Phillips screwdriver.

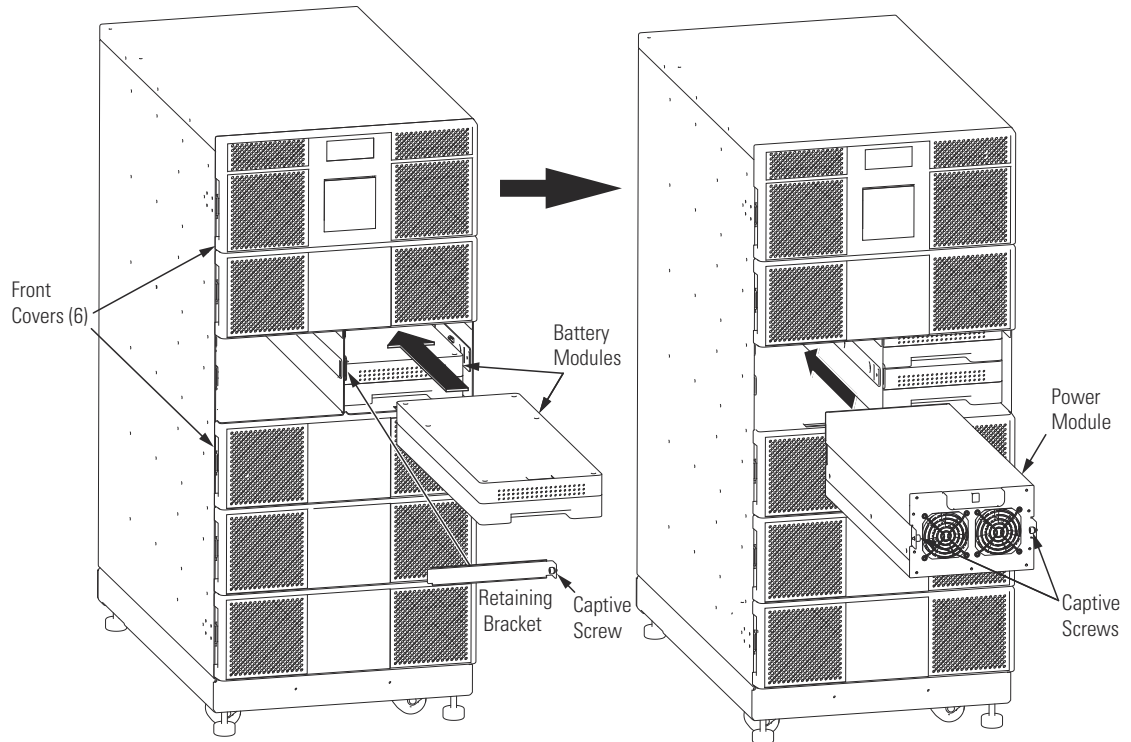

**Figure 43. Inserting the Modules**

5. If you installed the optional battery cabinets (EBMs), install the battery modules using the same procedure as the UPS modules. If applicable, install the super charger in the lower left slot of the EBM (see Figure 44)

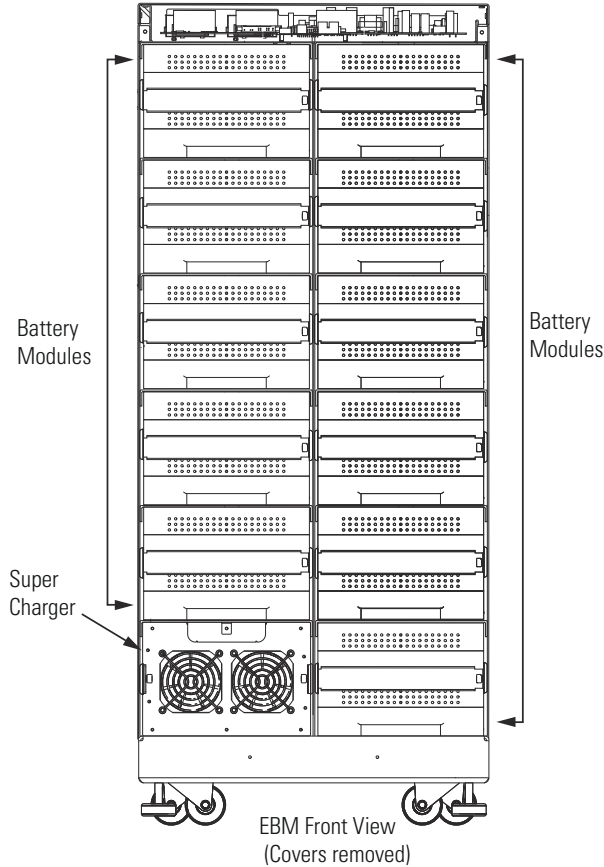

**Figure 44. EBM Battery Modules and Charger**

- 6. Replace the front covers and continue to "UPS Startup".

## UPS Startup

---

**CAUTION**



---

Confirm that an electrician has completed and tested all connections to the proper power source

---

To start the UPS unit for the first time after installation:

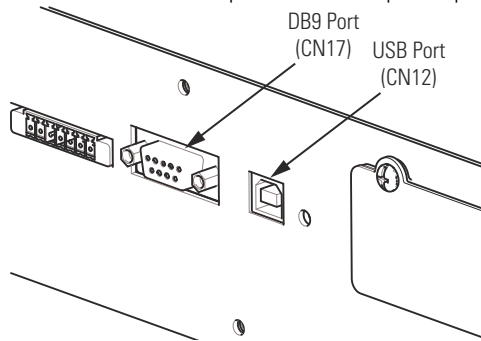
1. If external battery cabinets (EBMs) are installed, check the cable connections between the UPS and external battery cabinets (see Chapter 5, “Connecting the EBM(s) to the UPS” on page 41).
2. Ensure that all power modules and battery modules are properly installed into the UPS cabinet.
3. If you are using power management software, connect your computer to either the DB9 or USB communication ports on the top rear panel using the supplied communication cables.



**Figure 45. Communication Ports**

4. When starting the UPS, apply input power to the UPS by closing the service circuit breaker:
  - If external battery cabinets are installed, close the DC emergency disconnect switch button on the back of each external battery cabinet. Insert the switch key supplied with the cabinet into the button and turn clockwise 1/2-turn. Pull the button out to close the switch. Turn the key back counter-clockwise, and remove the key.
5. The UPS control panel display automatically turns on whenever input power is present and at least one power module is installed (see Chapter 7, “Control Panel Operation” on page 57).
6. Set up the initial operating parameters through the control panel display (see “Initial Startup Parameters” on page 51).
7. If applicable, test proper operation of optional external control signals and computer communication before connecting the load. (See “DB-9 Communication Port” on page 73 for details.)
8. If there are receptacles on the UPS rear panel, plug the equipment to be protected into the UPS output receptacles.



**NOTE** DO NOT protect laser printers with the UPS because of the exceptionally high power requirements of the heating elements.

---

9. Turn on the equipment that is connected to the UPS.
10. If there is an external bypass switch, turn it to UPS. Otherwise, close the load distribution circuit breaker(s).

## Initial Startup Parameters



**NOTE** For a complete description of control panel operation menus and displays, see Chapter 7, “Control Panel Operation” on page 57.

The first time the UPS is turned on, you must set or verify certain operating parameters before placing the UPS into operation. To set these initial configuration parameters:

1. After the Eaton® logo screen appears, select the desired language for the display. Use the ▲ and ▼ buttons to scroll between English, French, and Spanish. Enter your selection by pressing the ↵ button.

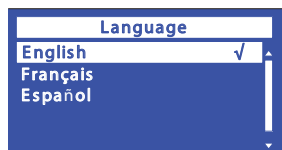

2. Select the desired UPS output voltage using the ▲ and ▼ buttons. Possible selections are 100/200, 110/220, 120/208, 120/240, 127/220 Vac. Press the ↵ button when the desired output value is displayed.

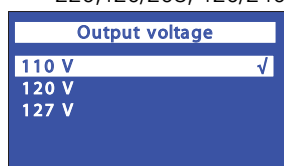

3. Set the clock for the local time and date.
  - If the time or the date is correct as displayed, press the ↵ button to advance to the next configuration setting. Time must be entered in 24-hour format.
  - If the time is incorrect as displayed, select the desired format and press the <- and -> buttons to move left and right. Press the ▲ and ▼ buttons to increase or decrease the value of each selected digit. When the displayed value is correct, press the ↵ button.

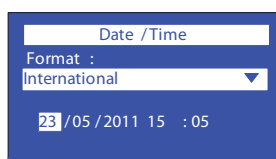

4. Select 'Register product' from the menu and register your product with Eaton.



5. The system signals an alarm when the required output cannot be maintained with the loss of redundant power modules. The alarm is essentially disabled with a redundancy level set at 0.
6. **Optional.** If you want the system to notify you when the number of redundant power modules is less than a specified level, enter a redundancy level. Each increment above 0 indicates the number of modules that can be removed from operation before the alarm occurs. This setting affects only the alarm; the system continues to operate as an N+X system even if this parameter is left at the default value of 0 (see also Figure 55 on page 64).

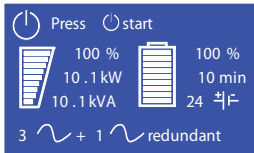

7. The UPS is now ready to operate, and displays the normal On/Off function screen. Press the ON button on the display screen to start the UPS.

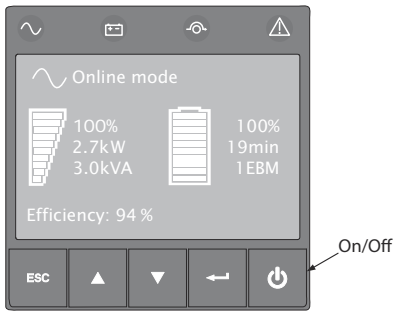

## NOTE





These configuration parameters are accessible during normal UPS operation by pressing the Menu screen through the front panel display.



## Chapter 7 Operation

### Normal Operation

To operate the UPS:

1. Verify the UPS startup procedure has been completed (see Chapter 6, “UPS Startup” on page 50)
2. The UPS control panel display illuminates and shows the EATON logo. See “Control Panel Operation” on page 57.
3. Verify that the power-on symbol  shows on the UPS status screen.
4. Press the  button on the UPS front panel until a beep sounds.
5. Check the UPS front panel display for active alarms or notices. Resolve any active alarms before continuing. See Chapter 11, “Troubleshooting” on page 91. If the  indicator is on, do not proceed until all alarms are clear. Check the UPS status from the front panel to view the active alarms. Correct the alarms and restart if necessary.
6. Verify that the  indicator illuminates solid, indicating that the UPS is operating normally and any loads are powered and protected.
7. Make sure the UPS is in Online mode.

### UPS Standby Mode

To place the UPS in standby:

Press the  button on the front panel for three seconds.

- The UPS starts to beep then transfers to Standby mode.
- The  indicator will flash continually.

### UPS Shutdown

---

 **CAUTION**

---

Observe all Lock-Out / Tag-Out procedures when external power is removed.

---

To shutdown the UPS completely:

- Place the UPS in standby
- Remove AC power by opening the building service circuit breaker or placing the bypass switch in SERVICE (if installed). Remove DC power by pressing the DC disconnect switch on the back of the EBM(s) and removing all battery modules from the UPS cabinet.

### Operating modes

The Eaton 9PXM front panel indicates the UPS status through the UPS indicators, see page 11.

#### Online Mode

During Online mode, the  indicator illuminates solid and the UPS is powered from the utility. The UPS monitors and charges the batteries as needed and provides filtered power protection to your equipment.

### Battery Mode

When the UPS is operating during a power outage, the alarm beeps once every ten seconds and the  indicator illuminates solid. The necessary energy is provided by the battery. When the utility power returns, the UPS transfers to Online mode operation while the battery recharges.

### Low-Battery Warning

---

 **CAUTION**

---

If the low battery warning occurs, shutdown all applications on the connected equipment because automatic UPS shutdown is imminent.

---

If battery capacity becomes low while on Battery mode:

- The  indicator illuminates solid.
- The audible alarm beeps once every 3 seconds. (This warning is approximate, and the actual time to shutdown may vary significantly.)
- After the UPS shuts down the UPS automatically restarts when utility power is restored (if Auto Restart is enabled).

### End of Battery Backup Time



- All the LEDs go OFF.
- The audio alarms stops.

### Bypass Mode

In the event of a UPS overload or internal failure, the UPS transfers your equipment to utility power. Battery mode is not available and your equipment is not protected; however, the utility power continues to be passively filtered by the UPS. The  indicator illuminates. Depending on overload conditions, the UPS remains in Bypass mode for at least 5 seconds and will stay in this mode if three transfers to bypass occur within one hour.

The UPS transfers to Bypass mode when:

- User activates Bypass mode through the front panel.
- Overload between 105 and 110% for more than 30 seconds
- Overload above 115% for more than 200msecs
- Output Short
- Hardware fault
- Over Temperature on heatsinks

- 
-  **NOTE** Load imbalance between UPMs is <5%
-  **NOTE** The UPS shuts down after a specified delay for overload conditions listed above.
- 

### Return of AC Input Power

Following an outage, the UPS restarts automatically when AC input power returns (unless the auto restart function has been disabled) and the load is supplied again.

## Setting High Efficiency Mode

In High Efficiency mode, the UPS transfers to Online (or Battery) mode in less than 10 ms when utility fails. Transfers to High Efficiency mode will be active after 5 minutes of Bypass voltage monitoring: if Bypass quality is not in tolerance, then the UPS will remain in Online mode.

To set the High Efficiency mode:

1. Select Settings, In/Out settings, and High Efficiency mode (see Figure 55 on page 64).
2. Select Enabled and Enter to confirm.
3. The UPS transfers to High Efficiency mode after 5 minutes.



### NOTE

If the input is not stable after enabling HE Mode, the UPS will monitor the input for 5 minutes but if it is stable to begin with, it will transfer immediately.

---

## Configuring Bypass Settings

The following settings are available for configuring Bypass operation (see Figure 55 on page 64).



### CAUTION

Changing the Bypass settings changes UPS behavior and may result in decreased protection.

---

### Bypass Voltage Min Limit

The default disables a transfer to Bypass if the measured bypass voltage level is below the nominal output voltage -12%. You can configure the setting for another voltage value. This setting can be overruled by the "Protected Bypass" setting.

### Bypass Voltage Max Limit

The default disables a transfer to Bypass if the measured bypass voltage level is above the nominal output voltage +12%. You can configure the setting for another voltage value. This setting can be overruled by the "Protected Bypass" setting.

### Protected Bypass (Enabled)

Allows a transfer to Bypass only when Bypass is within the following specifications:

- Bypass voltage is between the "Bypass Voltage Low Limit" and "Bypass Voltage High Limit" settings
- Bypass frequency is within 5% of nominal frequency.

### Unsynchronized Transfers

When Qualify Bypass is set to "Always" or "Always on Fault" you can select the interruption time when transferring to bypass, default setting is "Half Cycle" but can be changed to "Full cycle."

## Configuring battery settings

The following battery settings enable battery tests, alarms and enable auto mode and (see Figure 57 on page 66).

## Advanced Battery Management

Advanced Battery Management (ABM) extends the life of the battery by shutting off the charger for 28 days per ABM cycle and therefore reduces grid corrosion in the battery caused by trickle charging over long periods of time. Disabling ABM means the battery chargers run in constant charge mode and never turn off. The battery test period is every three ABM cycles.



**NOTE** It is not recommended to perform a battery discharge test more often than 90 days.

---

## Auto Battery Test

Automatic battery tests are programmable in constant charging mode and at each cycle in ABM mode. The tests frequency can be modified. During the test, the UPS transfers to Battery mode and discharges the batteries for 25% battery time remaining. The battery test will run only in Rest Mode and if ABM is enabled.



**NOTE** Battery mode is not displayed and battery low alarm does not activate during a battery test.

---

The battery test may be postponed due to bad conditions, or failed if battery is not ok.

## Low Battery Warning

During discharge, the low battery alarm is activated if the remaining runtime goes below 3 minutes or less than the setting capacity threshold (0% by default). This threshold can be modified.

## External Battery Setting

The number of Extended Battery Module is automatically detected, or can be set manually in number of EBM or in Ah.

## Deep Discharge Protection

This setting is recommended to avoid damaging the battery. Warranty is void if deep discharge protection is disabled.

## Retrieving the Event log

To retrieve the Event log through the display:

1. Press any button to activate the menu options, then select Event log (see Figure 61 on page 69).
2. Scroll through the listed events.
3. Reset event log if desired.

## Retrieving the Fault log

To retrieve the Fault log through the display:

1. Press any button to activate the menu options, then select Fault log (see Figure 62 on page 69).
2. Scroll through the listed faults.
3. Reset fault log if desired.

### Control Panel Operation

The control panel provides UPS function and control settings.

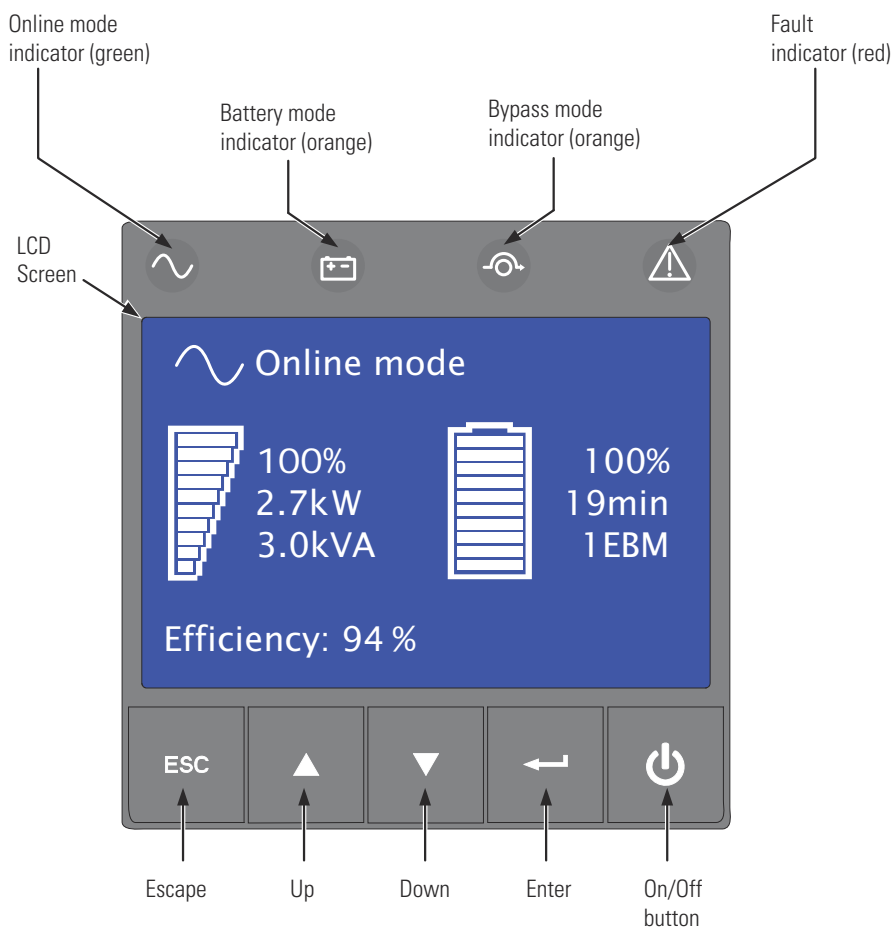





**Figure 46. UPS Control Panel**

### Display functions

Press the Enter (↵) button to activate the menu options. Use the two middle buttons (▲ and ▼) to scroll through the menu structure. Press the Enter (←) button to select an option. Press the ESC button to cancel or return to the previous menu (see Figure 46).

The following table shows the indicator status and description:

Indicator	Status	Description
 Green	On	The UPS is operating normally on Online or High Efficiency mode.
 Orange	On	The UPS is on Battery mode
 Orange	On	The UPS is on Bypass mode.
 Red	On	The UPS has an active alarm or fault. See Chapter 11, "Troubleshooting" for additional information.

### LCD Description

After five minutes of inactivity, the LCD displays the screen saver.



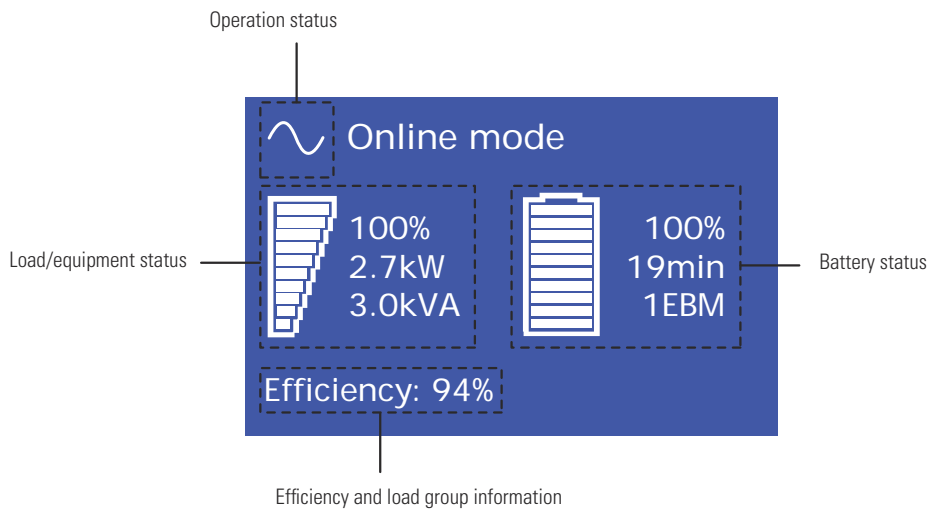



The LCD backlight automatically dims after 10 minutes of inactivity. Press any button to restore the screen.



**Figure 47. LCD Display Status Indicators**



## Display Status Indicators

The following table describes the status information provided by the UPS. If another indicator not shown appears, see Chapter 11, “Troubleshooting” for additional information.

Indicator	Status	Description
	The UPS is Off, waiting for startup command from user. The ~ indicator flashes continually.	Equipment is not powered until  button is pressed. Green LED blinking when UPS is in Standby mode.
	The UPS is operating normally. The ~ indicator is on steady.	The UPS is powering and protecting the equipment.
	A utility failure has occurred and the UPS is on Battery mode.	The UPS is powering the equipment with the battery power. Prepare your equipment for shutdown.
1 beep every 10 seconds		
	The UPS is on Battery mode and the battery is running low.	Low Battery Warning settings: [Capacity] [0%]...[100%] [Runtime] [0mn]...[60mn] The alarm triggers when the set percentage of battery capacity or remaining back-up time is reached.
1 beep every 3 seconds		
	The UPS is operating on High Efficiency mode.	The UPS is powering and protecting the equipment
	An overload or a fault has occurred, or a command has been received, and the UPS is in Bypass mode.	Equipment is powered but not protected by the UPS.

**Figure 48. Status Indicators**

## Changing Parameter Settings

The LCD display menus can be selected to show measurements, change control settings and show UPS and event logs. Use the two middle buttons ( and ) to scroll through the menu screens then press the Enter () button to select an option (see Figure 50 to Figure 64).

## Display Menu Screens

The figures in this section show the available menu selections from the control panel.

### Start Screen

The start screen shows the required information at first startup.

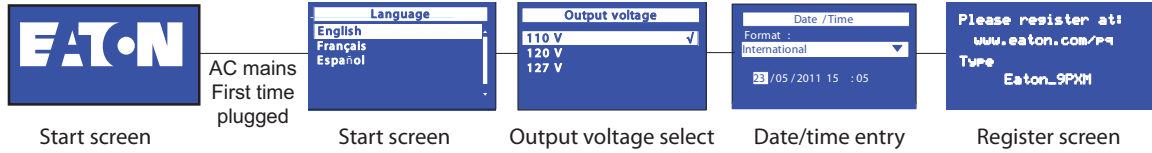

**Figure 49. Start Screen Menu**

### Status Screen

The status screen shows the status of the installed units.

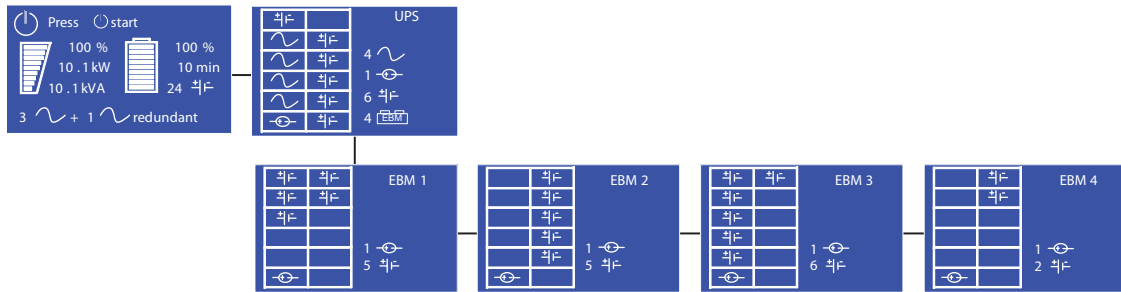

**Figure 50. Status Screen Menu**

### Menu Screen

The Menu Screen selects and controls system features and operating conditions (see Figure 51). Menu items include:

- Measurements
- Control
- Settings
- Event Log
- Fault Log
- Identification
- Registration Information

The Menu screen is the main menu and shows the available sub-menus.

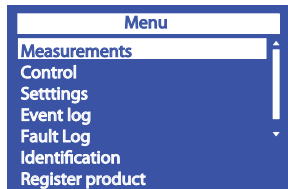

**Figure 51. Menu Screen**



### Measurements

The Measurements screen shows the measurements of the installed units.



Figure 52. Measurements Menu

### Control

The Control menu provides bypass control and reset of some fault and factory settings.

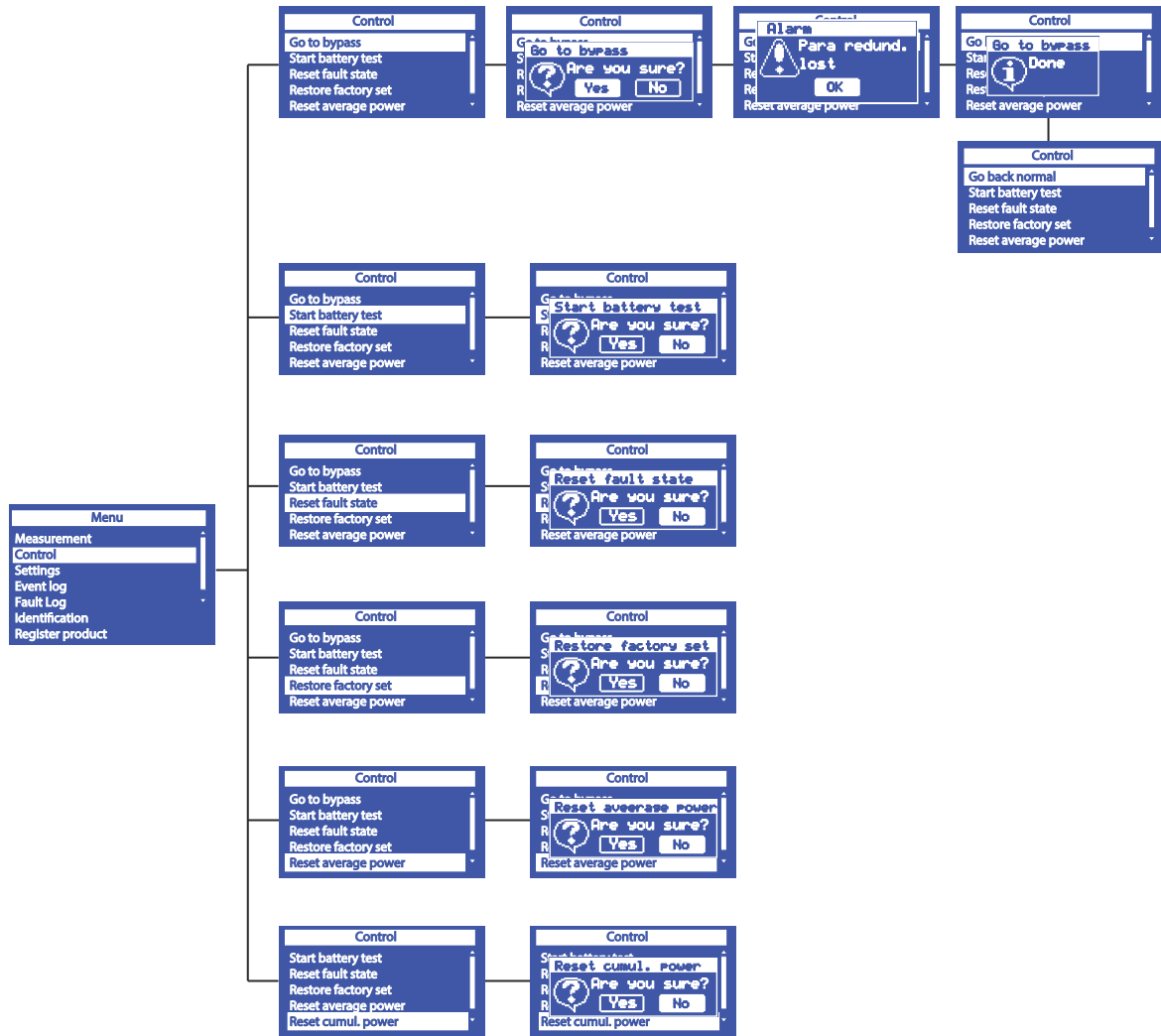
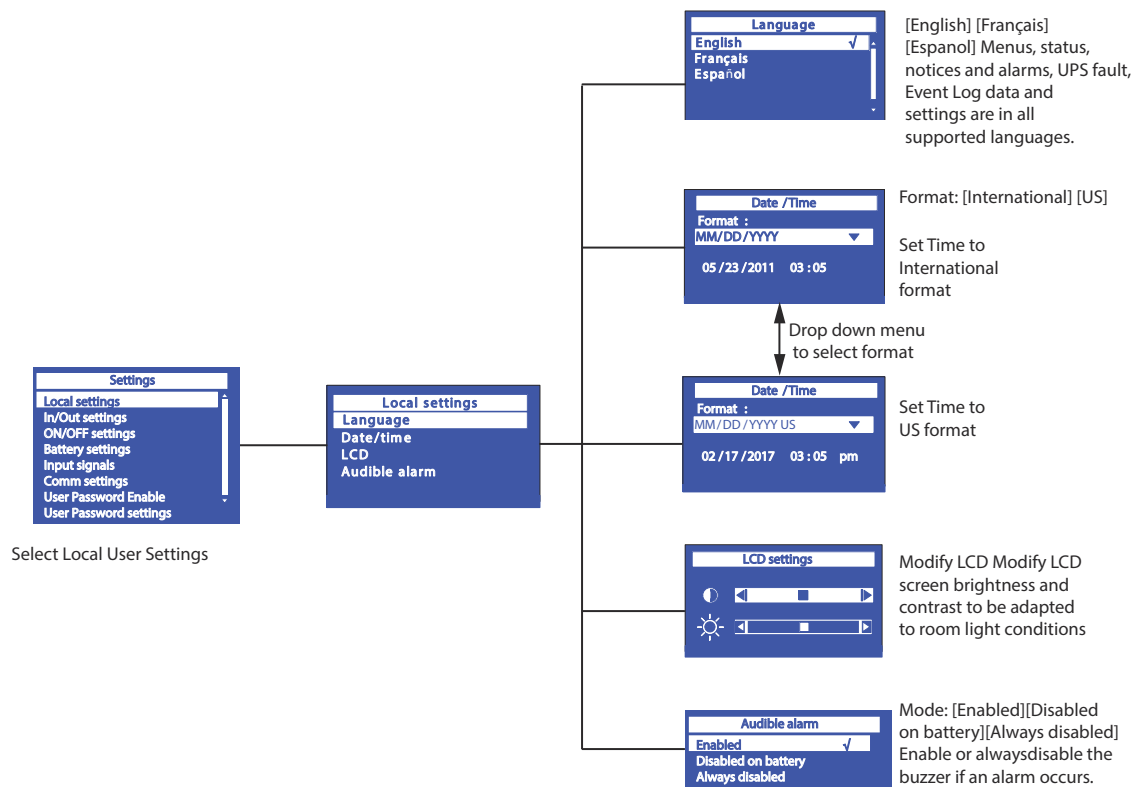

Figure 53. Control Menu

### Local Settings

The Settings menus allow the user to modify UPS settings.



**Figure 54. Local Settings Menu**

### In/Out Settings

The In/Out Settings menus allows control of input and output limits.

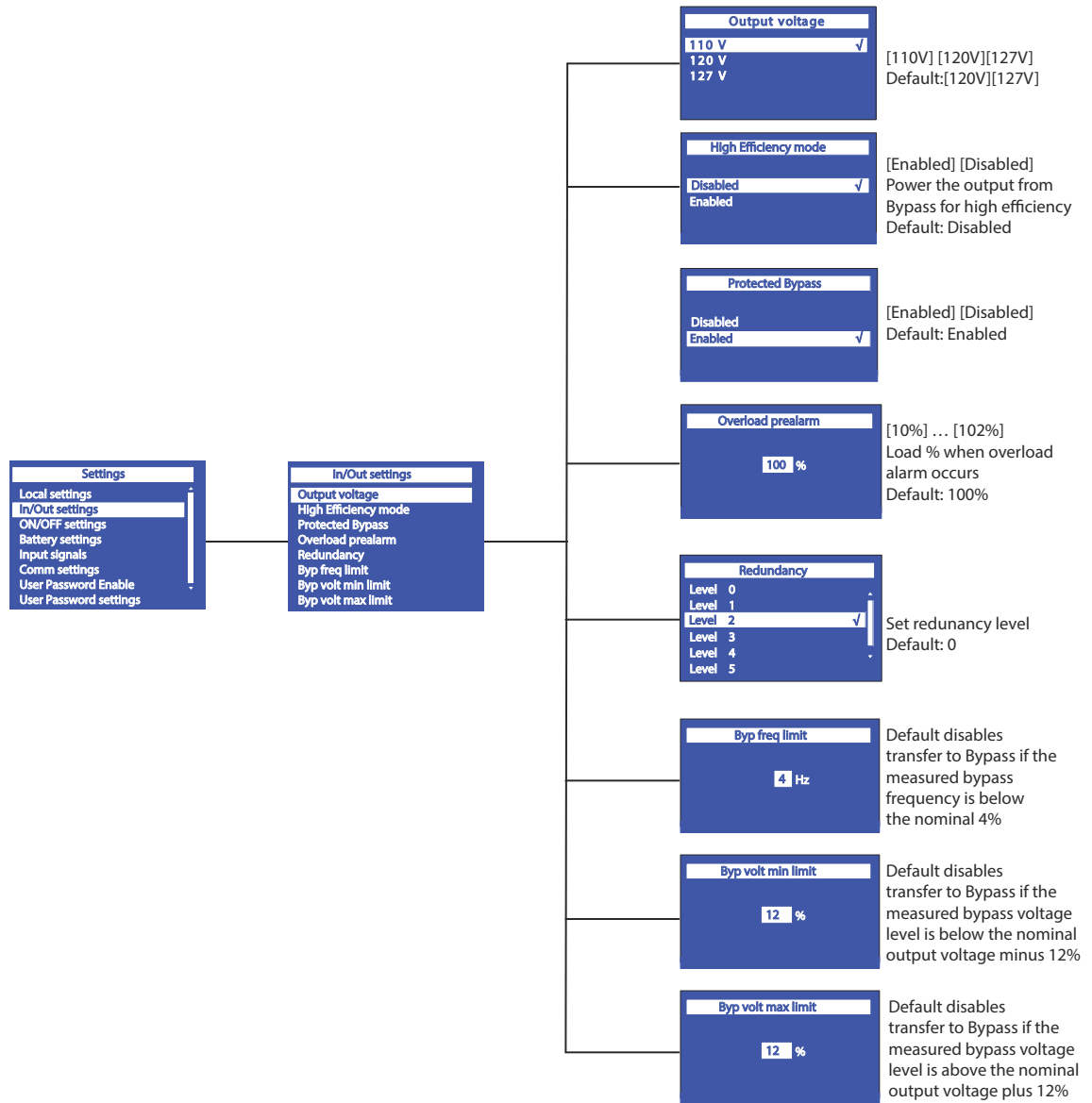

Figure 55. In/Out Settings Menu

### On/Off Settings

The On/Off Settings Menu enables/disables selected automatic restart and shutdown functions.

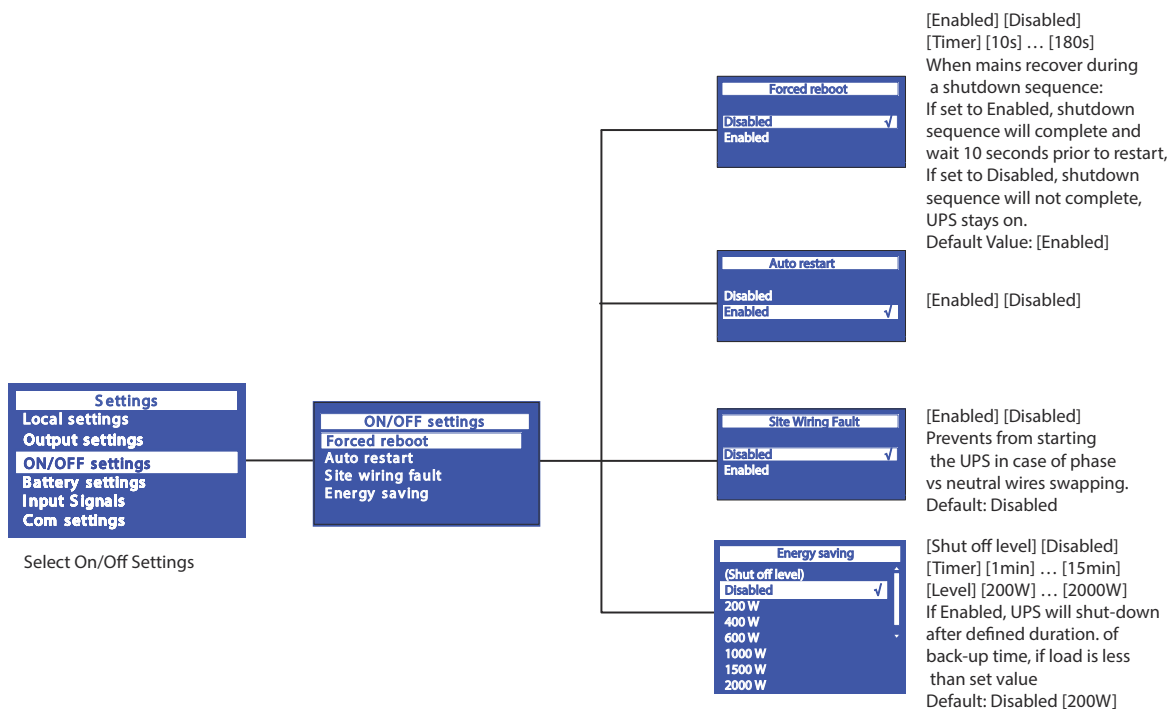

Figure 56. On/Off Settings Menu

### Battery Settings

The Battery Settings Menu provides control of battery tests, warnings and modes.

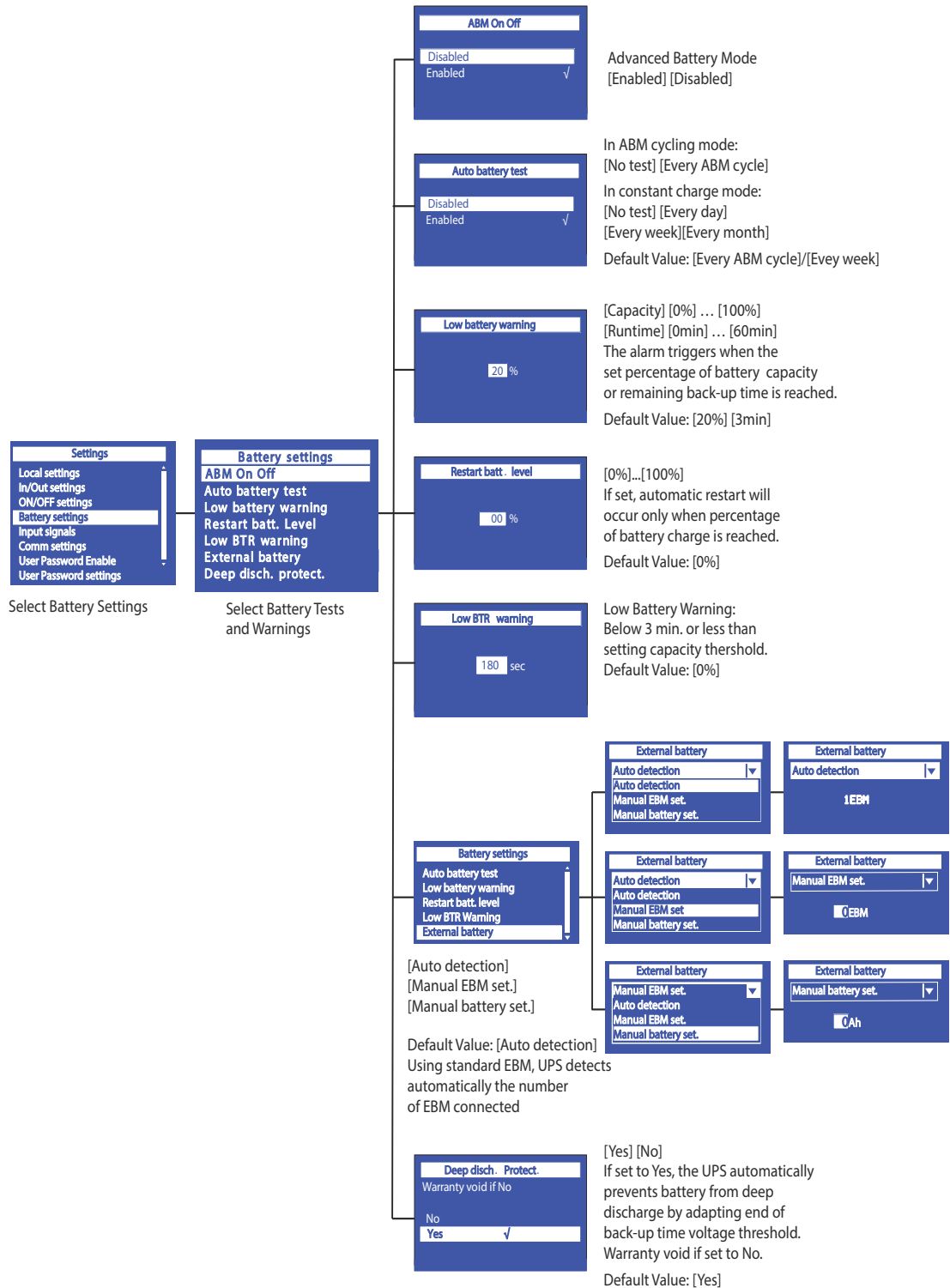

Figure 57. Battery Settings Menu

### Input Signals

The Input Signals Menu enables/disables power features for the UPS.

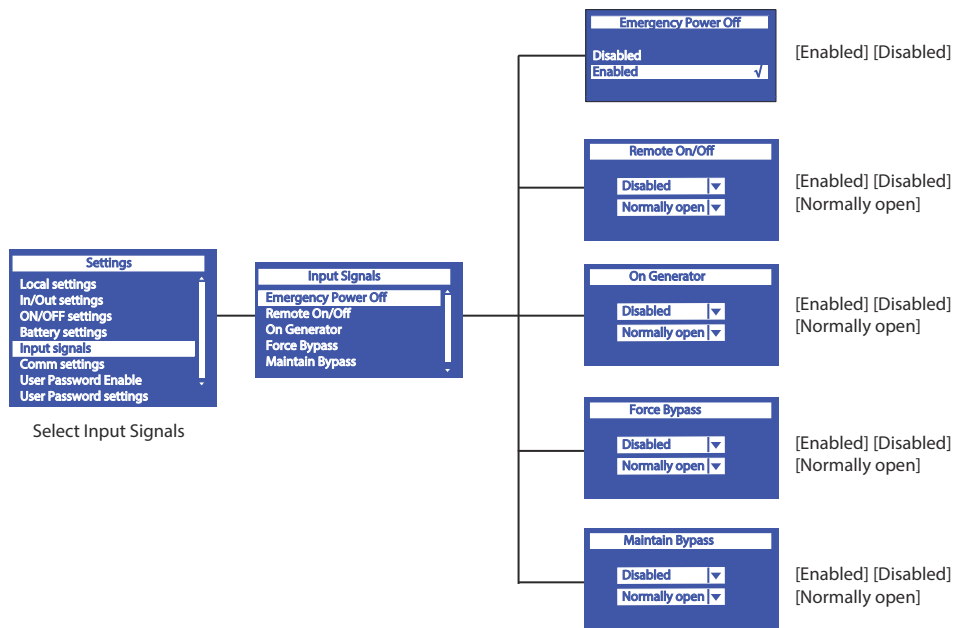
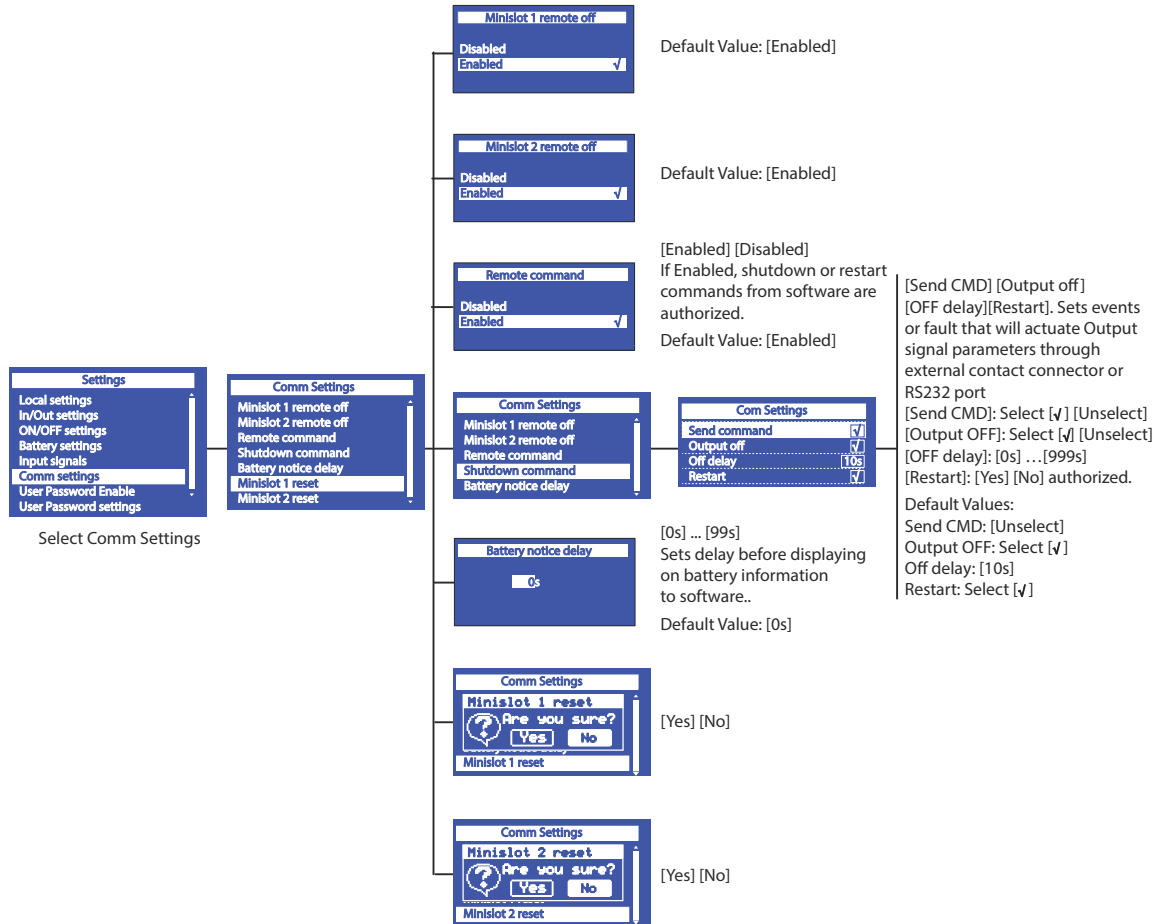

Figure 58. Input Signals Menu

### Comm Settings

The Comm Settings Menu enables/disables some selected control signal features.



**Figure 59. Comm Settings Menu**



### User Password Settings

The user password screens allow the user to enable password protection and change settings. Default value for user password is 1103.

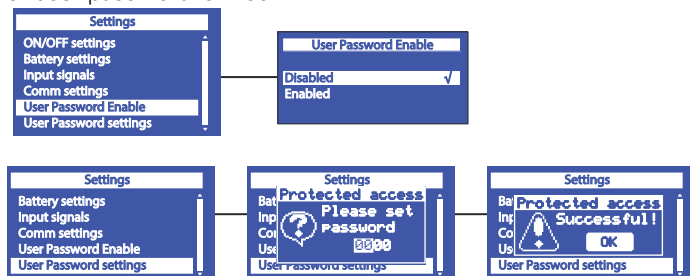

Figure 60. Password Menus

### Event Log

The Events Log screen shows the record of UPS events of the installed units.

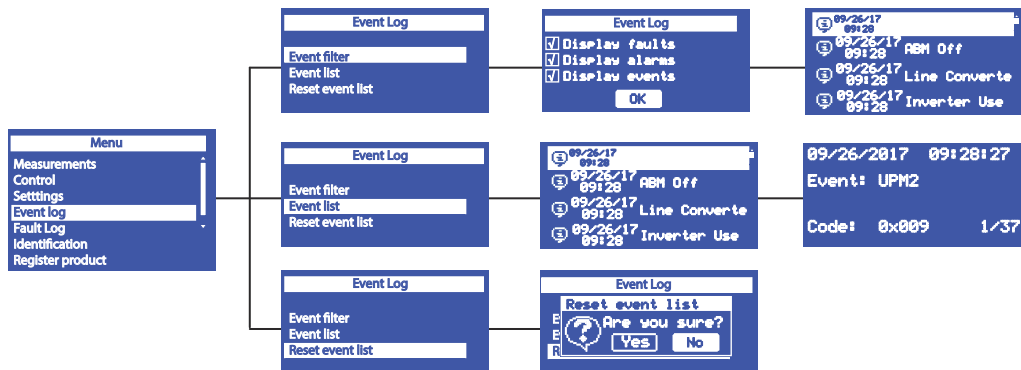

Figure 61. Event Log Menu

### Fault Log

The Fault Log screen shows the record of UPS faults of the installed units.

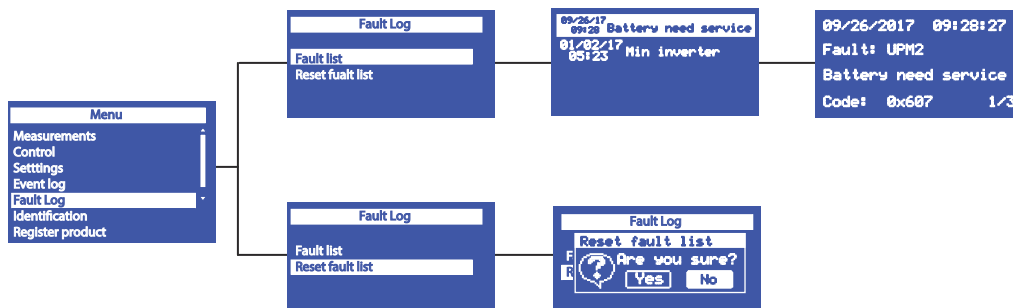

Figure 62. Fault Log Menu

### Identification

The Identification screen shows the product type and installed accessories.

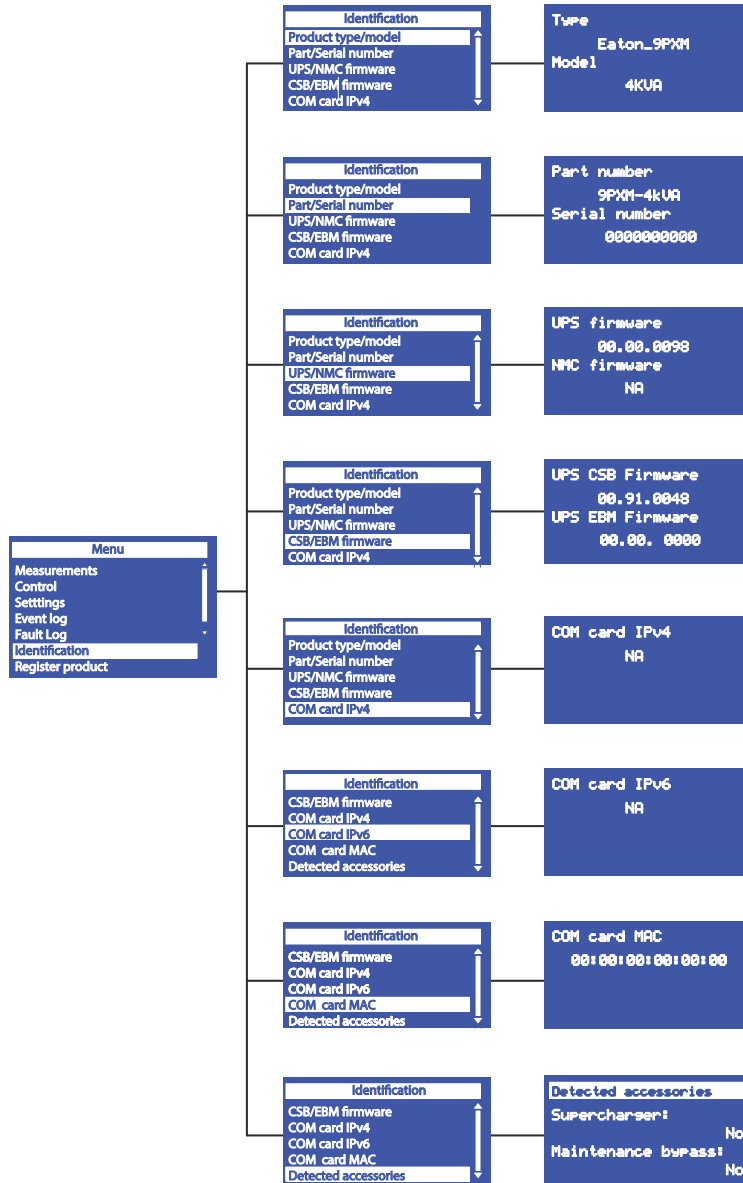

Figure 63. Identification Menu

### Registration Information

The Register product screen provides directions to register the product with Eaton.

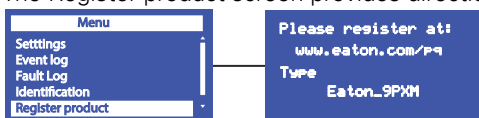

Figure 64. Register Product Menu

## Chapter 8 Communication

Eaton offers several methods of communicating with your Eaton 9PXM system in addition to the front panel display:

- Intelligent Power Manager® (IPM) Power Management Software
- Optional Interface Kits
- Communication ports
- Dedicated Input Signals
- DB-9 Communication Port
- Communication slots

### Intelligent Power Manager

Eaton's Intelligent Power Manager (IPM) software provides the tools needed to monitor and manage power devices in a physical or virtual environment. This innovative software solution ensures system uptime and data integrity by allowing the user to remotely monitor, manage and control UPSs and other devices on their network. IPM provides a solution that is easy to use and maintains business continuity.

### Optional Interface Kits

For computer systems that already have UPS monitoring software, Eaton offers interface cable kits for connecting the Eaton 9PXM system to your computer system. The kit includes the cable, adapters, and instructions.

### Communication Ports

#### UPS Communication Ports

External communication ports are located on the top rear panel of the UPS (see Figure 65). They are identified as follows:

- CN6 - ROO and On-Generator signals
- CN5 - Building input signals (for future option)
- CN13 - Maintenance bypass signals
- CN7 - EPO
- CN4 - External slot select signals and External CAN signals, goes to EBM CSB
- CN17 - DB-9 (RS-232) port
- CN12 - USB port

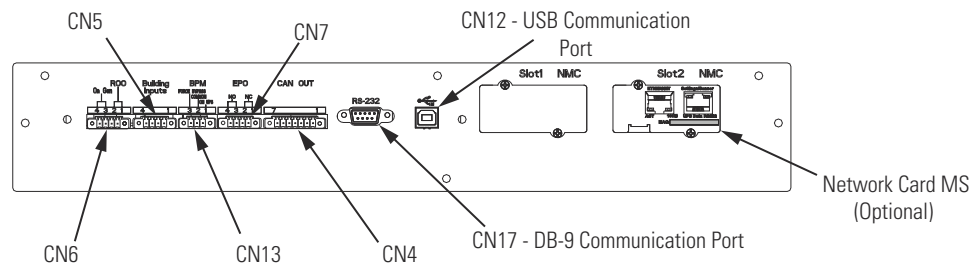
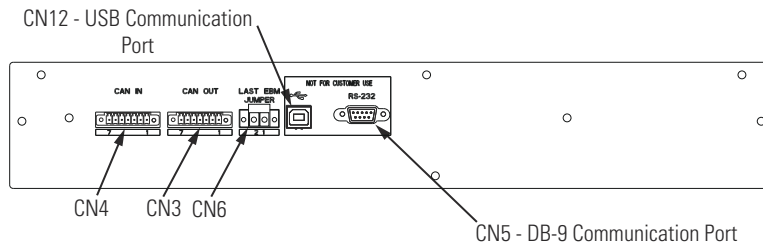

**Figure 65. UPS Communication Ports**

### EBM Communication Ports

External communication ports are located on the top rear panel of the EBM (see Figure 65). They are identified as follows:

- CN4 - External slot select signals and external CAN signals from UPS
- CN3 - External slot select external CAN signals to next EBM
- CN6 - External slot select Ret Act Pins (Do NOT install jumper)
- CN5 - DB-9 (RS-232) port
- CN12 - USB port



**Figure 66. EBM Communication Ports**

Refer to detail A in Figure 32 on page 37 for the type of signal connectors used.

### Dedicated Input Signals

**Emergency Power-off (EPO):** Connection to a facility Emergency Shutdown switch provides a method for emergency Eaton 9PXM system shutdown. Opening this connection creates an immediate shutdown of the Eaton 9PXM UPS output.

**Maintenance Bypass:** The signal from an external bypass switch, to isolate the Eaton 9PXM system for maintenance purposes, tells the UPS to go into Internal Bypass mode.

**On-Generator:** An external signal can indicate that the input power is being supplied by a generator. Closure of this contact causes the UPS to change preset values that are designed to optimize performance during periods of generator instability:

See Figure 65 on page 71 to show the connections for all dedicated input signals.

## DB-9 Communication Port

Table 7 explains the functions of the pins on the Eaton 9PXM DB-9 communication port. This port is on the Eaton 9PXM UPS rear panel, as shown in Figure 65.

**Table 7. DB-9 Port Signals**

Pin	Function	Description
1	Low Battery Alarm	Pin 1 shifts from RS-232 Low (positive voltage) to RS-232 High (negative voltage) and remains high whenever the UPS enters a Low Battery alarm state.
2	RS-232 Transmit Data	Sends outgoing RS-232 communication data at 9600 baud, 8 bits, no parity, 1 stop bit.
3	RS-232 Receive Data/ RS-232 Shutdown	<p>RS-232 Receive Data Function. Receives incoming RS-232 communication data at 9600 baud, 8 bits, no parity, 1 stop bit.</p> <p>RS-232 Shutdown Function. If Pin 3 receives an RS-232 Low signal (+Vdc) for at least 5 seconds, but not more than 7 seconds, during an AC Failure condition, the UPS output shuts off following a delay of 120 seconds (<math>\pm 5</math> seconds).</p> <ul style="list-style-type: none"> <li>The UPS output shuts off even if the normal AC input power is restored during the 120 second delay.</li> <li>The UPS output automatically restarts after the UPS determines the normal AC input power is stable.</li> <li>The shutdown and restart timing represented by the functionality of Pin 3 is independent from the shutdown and restart timing specified from the host software.</li> </ul>
4	Reserved	Loopback to Pin 6
5	Common	Signal Ground
6	Reserved	Loopback to Pin 4
7	No Connection	Open pin
8	AC Fail Signal (On-Battery)	<p>Pin 8 shifts from RS-232 Low (positive voltage) to RS-232 High (negative voltage) and remains high for 15 seconds (<math>\pm 1</math> second) after the UPS detects an AC Failure condition, assuming the condition still exists after the 15 seconds.</p> <p>When the AC Failure condition no longer exists, the signal returns to the RS-232 Low state (positive voltage).</p>
9	No Connection/ DC Supply Voltage	<p>The UPS is factory-set with Pin 9 disconnected, but can be enabled through a technician-replaceable jumper inside the UPS. The jumper setting <b>MUST</b> be changed by a qualified service technician.</p> <p>When enabled, Pin 9 provides supply voltage for use with external connectivity devices requiring DC power directly from the UPS DB-9 port (nominal 12 Vdc/5W; 8V minimum, 24V maximum). Use only Eaton brand connectivity devices.</p>

## Communication Slots

The Eaton 9PXM UPS has two communication slots that allow quick installation of the optional communication cards. These interface cards extend the capabilities of the Eaton 9PXM system to provide compatibility with network and remote monitoring/management systems.

Type of connectivity cards that can be installed include:

### Network Card MS

The Eaton Network Card-MS allows an Eaton UPS to directly connect to the Ethernet network and the Internet, supporting real-time monitoring and control of UPSs across the network via a standard Web browser, SNMP-compliant network management system or power management software. Environmental monitoring is also possible via an Environmental Monitor Probe (EMP)

### **PXGX UPS Card**

The Eaton® Power Xpert® Gateway Card provides Web-enabled, real-time monitoring of Eaton uninterruptible power systems (UPSs) through standard Web pages, Power Xpert software, or third-party software. An integral part of the Eaton Power Xpert Architecture®, which provides end-to-end PowerChain Management™ solutions, the PXGX UPS Card provides a central point to connect UPSs to the Ethernet network.

### **Network and Modbus Card MS**

The Eaton Network and MODBUS Card-MS provides continuous, reliable and accurate remote monitoring of a UPS system through a Building Management System (BMS) or Industrial Automation System (IAS). Enabling data to be integrated from the UPS into a wide variety of management systems, the MODBUS Card-MS combines an SNMP agent, HTTP/Web server and a MODBUS card, facilitating UPS supervision from any network monitoring system using SNMP and traps, or any web browser.

### **Relay Card-MS**

The Eaton Relay Card-MS enables automatic shutdown and network monitoring of UPS system status through a connected computer with a dedicated adapter that provides the essential dry-contact interface between an Eaton UPS and any relay-connected computer as well as a variety of industrial applications. The Relay Card-MS is compatible with all Eaton UPSs that have a Minislot.

## Chapter 9 Maintenance

This chapter provides maintenance information to help maintain proper UPS operation.

### Routine Maintenance

---

**NOTE 1** Observe important safety precautions while performing these checks.



**NOTE 2** Eaton recommends that you schedule preventive maintenance checks at least every six months.

---

The Eaton 9PXM system is designed to provide years of trouble-free operation. Its internal control system checks the batteries and inverter periodically to ensure reliable operation.

The Eaton 9PXM UPS and optional external battery cabinets do require some attention to assure continued reliable service. Follow Eaton's recommended maintenance schedule, which includes:

- Check operating environment for clean, cool, dry conditions.
- Inspect and clean the area around the UPS
- Check operation of fans (power modules).
- Check the batteries.

For more information on preventive maintenance checks, contact your service representative.

### Storage Temperature

Store the Eaton 9PXM battery modules (in the UPS or external battery cabinet) at  $-20$  to  $+40^{\circ}\text{C}$  ( $-4$  to  $+104^{\circ}\text{F}$ ). Batteries will have a longer shelf life if they are kept below  $+25^{\circ}\text{C}$  ( $+77^{\circ}\text{F}$ ). The Eaton 9PXM UPS or battery cabinet without batteries may be stored at  $-40$  to  $+60^{\circ}\text{C}$  ( $-40$  to  $+140^{\circ}\text{F}$ ).

### External Bypass Switch (Make-Before-Break Only) Operation

Press the red button beside the switch before turning the Eaton MBB bypass switch. This button:

- Sends an electrical signal to the UPS to switch to the internal Bypass mode (if it is not already operating in that mode).
- Operates a mechanical interlock, to prevent the switch from being turned without first signaling the UPS.



**NOTE** When the red button is released, the UPS remains in its internal Bypass mode. Return the UPS to Auto mode by selecting that mode on the front panel display.

---

See “Bypass Module Operation” on page 27 for additional information.

### Battery Replacement

The Eaton 9PXM hot-swappable feature lets you replace the battery modules without disconnecting the load or damaging the batteries.



**NOTE** The Eaton 9PXM UPS will operate with uncharged (or no) batteries, but will have limited (or no) battery backup capability. The recommended backup is one two-battery slot for each power module. The UPS may indicate an alarm with no batteries present.

---

To replace a two-battery slot in pairs:

1. Remove the front cover.  
The cover has magnetic latches on the left and right sides that hold it in place.
2. Loosen the captive screw on the retaining bracket and slowly pull the upper battery module out of the cabinet.
3. Repeat the procedure with the lower battery module.
4. Treat the original and replacement battery modules with care to avoid damaging connectors or internal circuitry. Label the original batteries with masking tape or some other identifier. Record the serial number of the replacement modules for your warranty.
5. Insert the replacement battery modules by sliding the lower module carefully into the cabinet. Repeat for the upper replacement module.
6. Reinstall the retaining bracket and tighten the captive screw.
7. Replace the front cover.

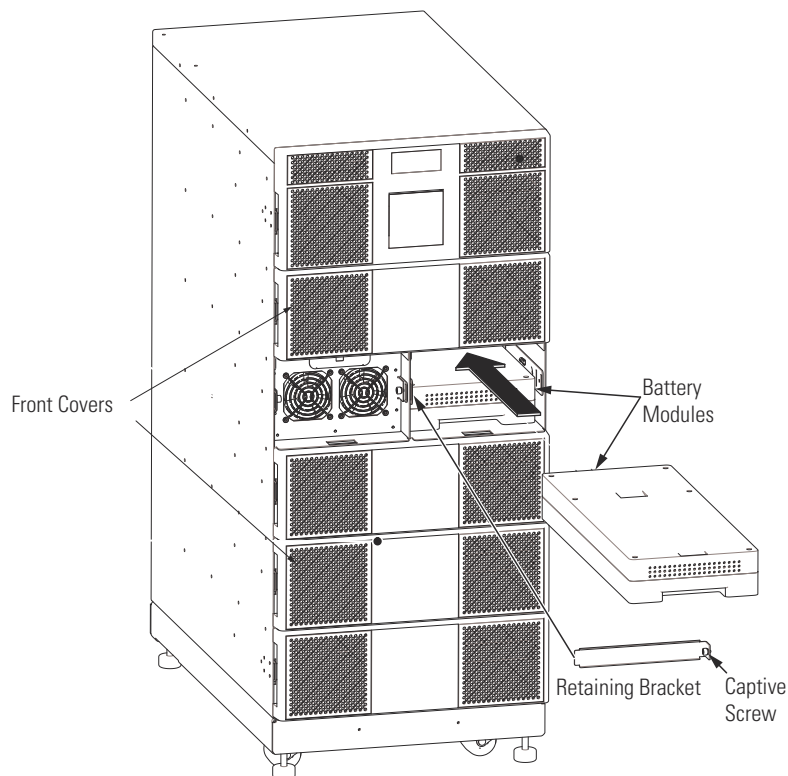

**Figure 67. Battery Replacement**

## Power Module Replacement

The Eaton 9PXM easy replace feature lets you replace a power module without disconnecting the load or damaging the UPS.



**NOTE** The UPS may switch to internal Bypass mode if the remaining power modules are insufficient to supply the required power. If empty slots exist, install replacement modules before removing original ones.



Use care in removing and installing power modules. To remove a power module:

1. Remove the front cover.  
The cover has magnetic latches on the left and right sides that hold it in place.
2. Loosen the captive screws at the sides of the power module and slowly pull the power module out of the cabinet.
3. Treat the original and replacement power modules with care to avoid damaging connectors or internal circuitry. Label the original power modules with masking tape or some other identifier. Record the serial number of the replacement power modules for your warranty.
4. Insert the replacement power module by sliding it carefully into the cabinet.
5. Tighten the captive screws to the UPS cabinet.
6. Replace the front cover.

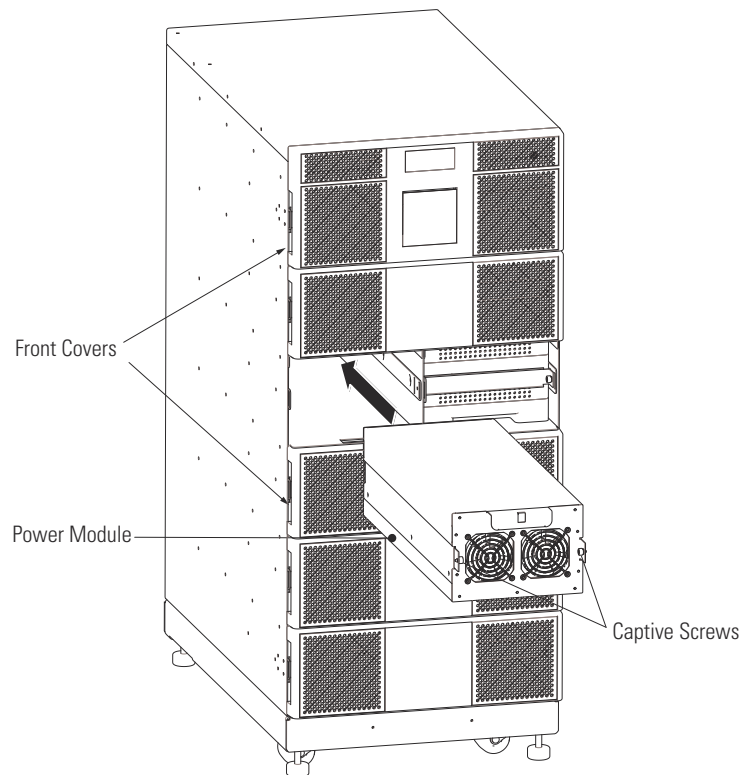

**Figure 68. Power Module Replacement**

## UPS Firmware Upgrade

This procedure is intended for the firmware upgrade of the 9PXM UPS model. Please follow these steps carefully to ensure complete success of the firmware upgrade on this model UPS. The firmware can be upgraded via RS232 connection or USB connection. If a USB connection is used, Option 2 from the Main menu, will be a required step in this process. The process requires a file download to your laptop/PC then installation of the firmware to the UPS.

### Prerequisites

The following is required for the firmware download to your computer:

- Windows Operating System
- 7 zip application installed
- Administrative permissions
- Do not use PCs with UPS protection software installed (ie. IPM or IPP)

### Unpacking the Downloaded Zip File

1. Download the upgrade tool from the Eaton website. The file will look similar like the following:
  - SetUPS-9PXM-Toolv1\_XX\_XXX.7z
2. Double-Click on the file and extract the contents into a single newly created folder:

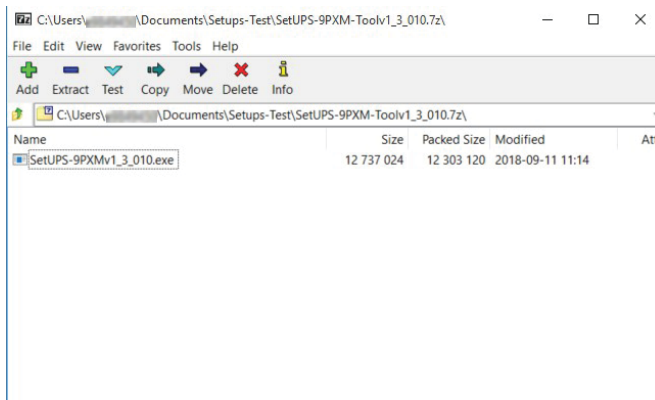

**Figure 69. Extract Zip File to Unzip Folder**



The name of the new folder is of the user's discretion. It is recommended to create a folder off the root of the hard drive for ease of access. The folder name must not contain spaces.

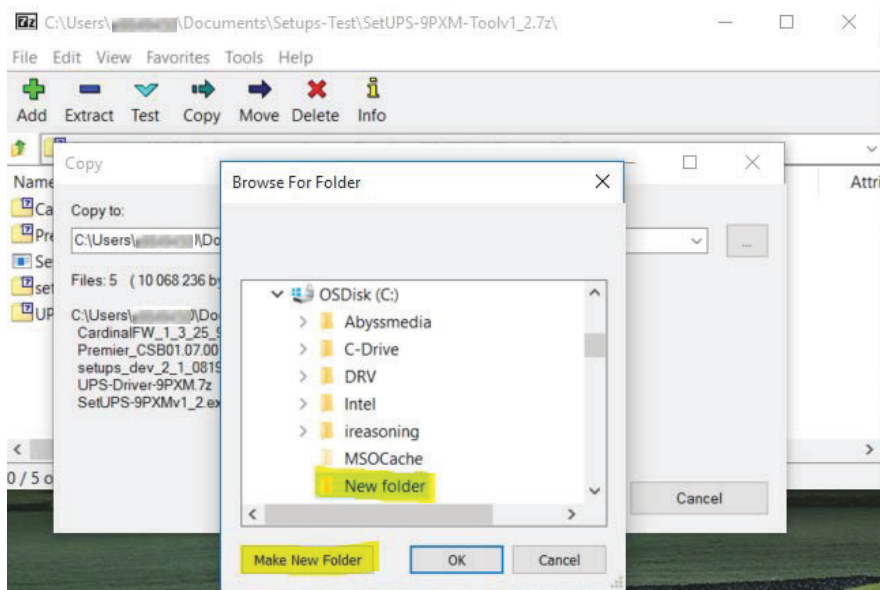

**Figure 70. Create Unzip Folder**

3. Use 'eaton' as the password when prompted during the extraction process.

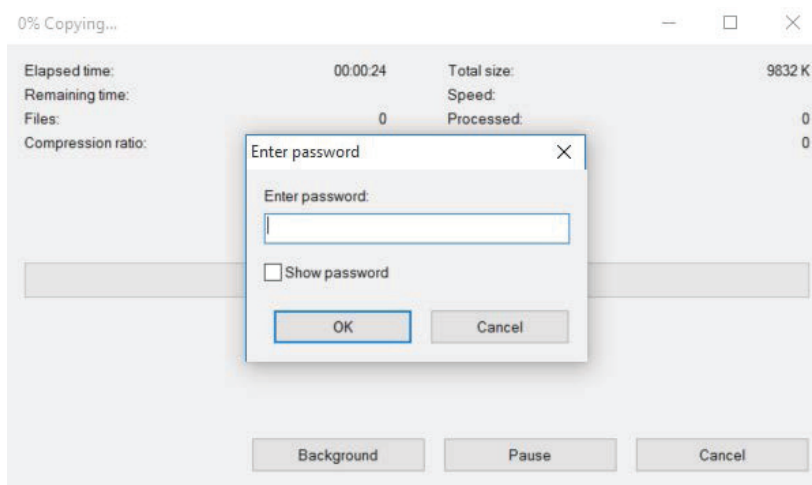

**Figure 71. Enter Extraction Password**

4. After the extraction is complete the following files will be visible in the new folder that was created:

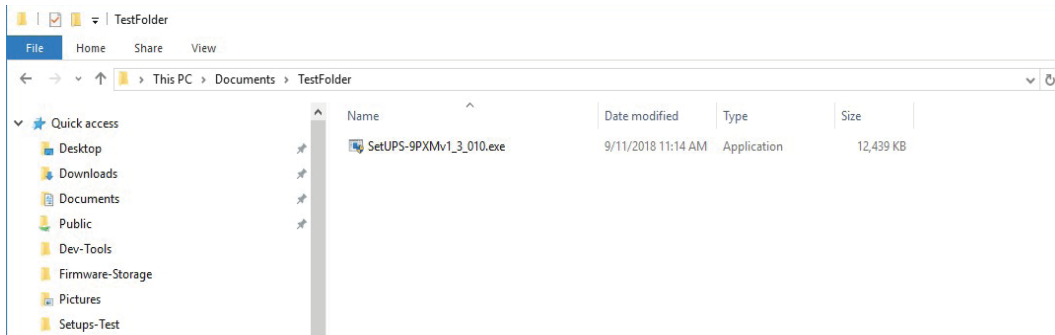

**Figure 72. Extracted Firmware Files**

### Launch the Firmware Upgrade Tool

1. Double-click on the file 'SetUPS-9PXMv1\_2.exe'
2. You should see the following:

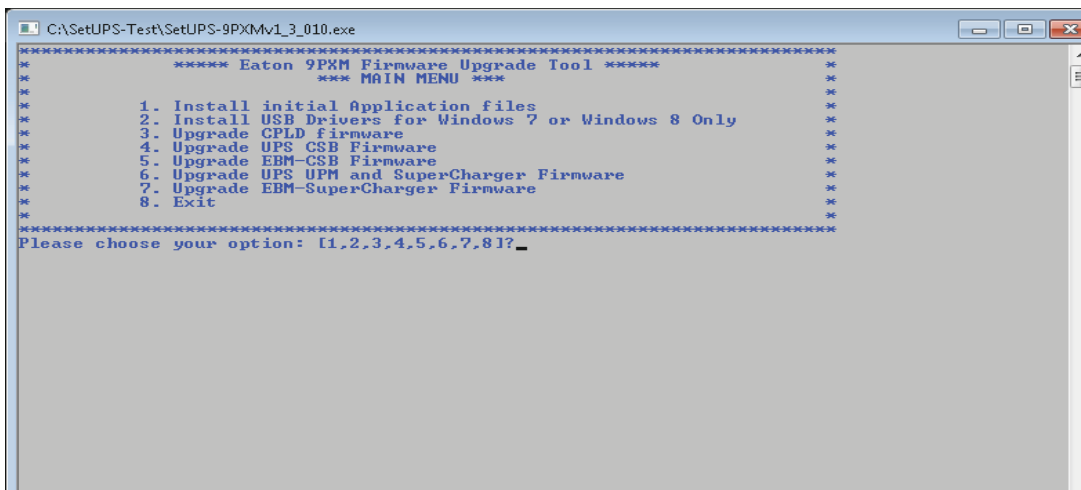

**Figure 73. Firmware Upgrade Tool Window**

3. Choose option 1 from the Main menu to install the initial files to the local computer.

---

 This step should only be run once if successful the first time.

---

### USB Connection to the UPS (Initial Required Step for USB Connections Only)

---

 This step should only be run once if successful the first time.

---

1. On your computer choose option 2 from the Main menu to install USB drivers
2. Select the driver that is suited for the Windows PC used for the upgrade from the secondary menu.

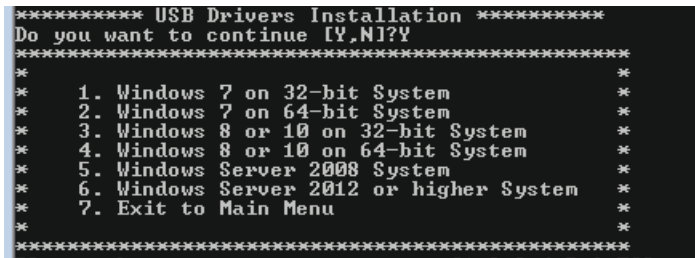

**Figure 74. Windows Drivers**

3. An additional window will launch to complete the installation of the driver.
4. Connect to the UPS with the provided USB cord.
5. Verify the connection to the UPS:
  - a. Launch the device manager.
  - b. Under the Ports Section, look for the “STMicroelectronics Virtual COM Port” device.
  - c. Note the Com# for later use. (if Com# is higher than 10, reassign to a lower Com# (Eaton prefers Com# between 2 and 5)).

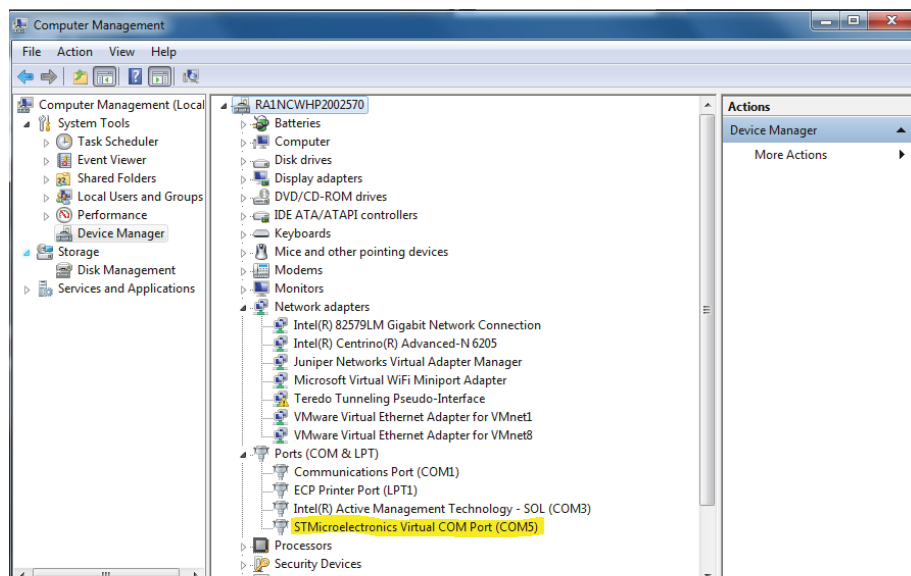

**Figure 75. Window Device Manager Selection**

**NOTE 1** This device can only be seen when connected to the UPS, which means if this device is seen then it is successfully communicating with the UPS.



**NOTE 2** These steps only need to be completed once. However, it is good practice to complete step 5 prior to starting any firmware upgrade.

The tool is ready to proceed with firmware upgrades.

### UPS CSB firmware Upgrade

1. Place the UPS in standby mode (**Do not use bypass mode**).
2. Choose option 4 from the Main menu and confirm to run CSB firmware upgrade.

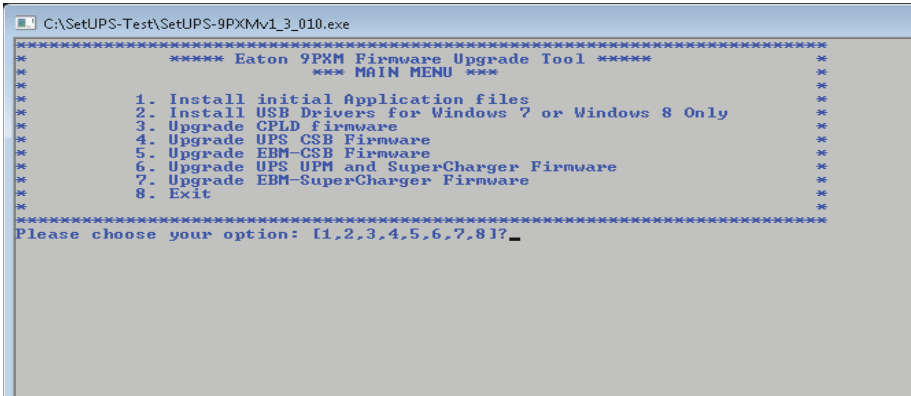

**Figure 76. CSB Upgrade Selection**

3. The firmware upgrade will begin stating the current time.

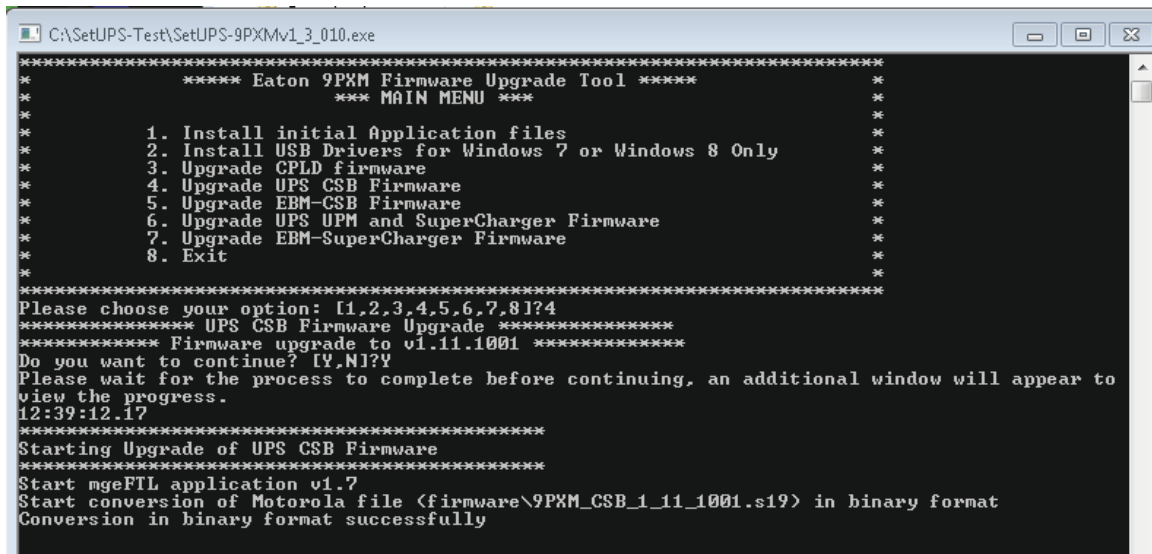

**Figure 77. Upgrade Initialization**

4. Once communication is established the UPS will be switched to bootloader mode. During the period, do not disconnect power or disconnect the communication cord.

```

C:\SetUPS-Test\SetUPS-9PXMv1_3_010.exe
*****
***** Eaton 9PXM Firmware Upgrade Tool *****
*****
***** MAIN MENU *****
*****
1. Install initial Application files
2. Install USB Drivers for Windows 7 or Windows 8 Only
3. Upgrade CPLD firmware
4. Upgrade UPS CSB Firmware
5. Upgrade EBM-CSB Firmware
6. Upgrade UPS UPM and SuperCharger Firmware
7. Upgrade EBM-SuperCharger Firmware
8. Exit
*****
Please choose your option: [1,2,3,4,5,6,7,8]?4
***** UPS CSB Firmware Upgrade *****
***** Firmware upgrade to v1.11.1001 *****
Do you want to continue? [Y,N]?Y
Please wait for the process to complete before continuing, an additional window will appear to
view the progress.
12:39:12.17
*****
Starting Upgrade of UPS CSB Firmware
*****
Start mgeFTL application v1.7
Start conversion of Motorola file (firmware\9PXM_CSB_1_11_1001.s19) in binary format
Conversion in binary format successfully

```

**Figure 78. Communication Types**

5. The application will evaluate the firmware package and display that it was located and loaded into memory. It will also display the size and the channel# in which the firmware will be uploaded.
6. The application will then set the UPS into Bootloader mode. If this is completed successfully, the current firmware is erased in preparation for the new firmware to be uploaded. At this point, the application will begin to upload the new firmware.
7. The upload will continue to run for about twenty minutes.

### ⚠ CAUTION

During this time, do not attempt to close any windows, remove the connect between the UPS and upgrade PC, operate, work on, or remove any modules from the UPS.

8. During the upload, the LCD screen on the UPS will blackout. This is normal and it will be fully operational again once the upload is complete.
9. Before attempting to run the application again fully power-cycle the UPS.

### UPS UPM or EBM UPM and SuperCharger Firmware Upgrade

1. Choose Option 6 or 7 from the Main menu and confirm for UPM firmware upgrade:

```

C:\SetUPS-Test\SetUPS-9PXMv1_3_010.exe
*****
***** Eaton 9PXM Firmware Upgrade Tool *****
*****
***** MAIN MENU *****
*****
1. Install initial Application files
2. Install USB Drivers for Windows 7 or Windows 8 Only
3. Upgrade CPLD firmware
4. Upgrade UPS CSB Firmware
5. Upgrade EBM-CSB Firmware
6. Upgrade UPS UPM and SuperCharger Firmware
7. Upgrade EBM-SuperCharger Firmware
8. Exit
*****
Please choose your option: [1,2,3,4,5,6,7,8]?_

```

**Figure 79. UPM - EBM/Supercharger Firmware Menu**

2. Wait for the program to begin
3. Enter the communication port to be used for the upgrade. This can be viewed in the device manager of the operating system, (See Figure 75 on page 81).
  - a. Verify the physical connection from the PC to the UPS or EBM device
  - b. RS232 (usually COM1)
  - c. USB to RS232 (assigned COM port)
  - d. USB (assigned Virtual COM port)

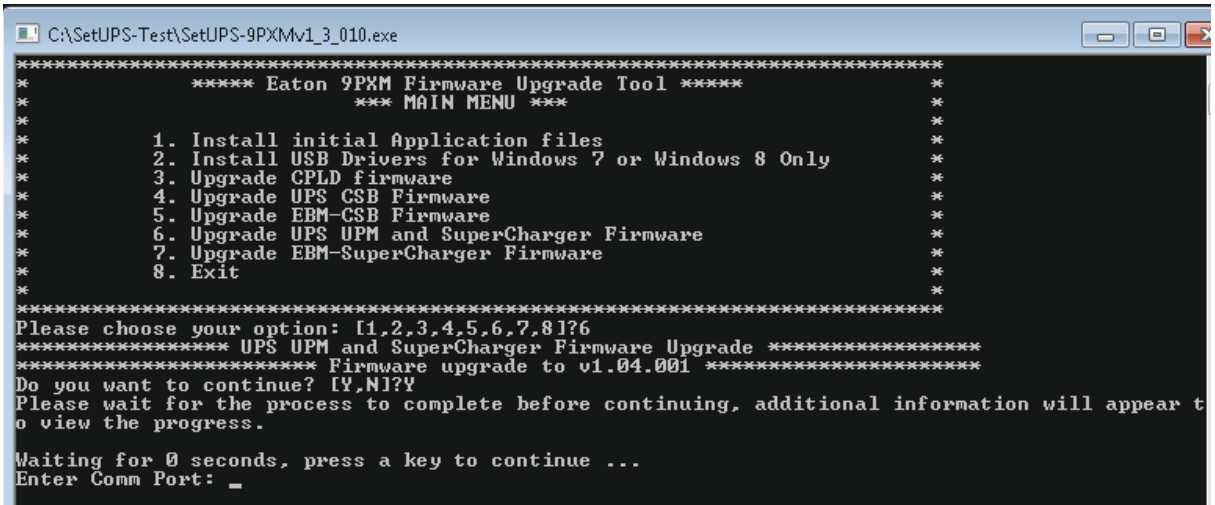

**Figure 80. Firmware Comm Port Selection**

4. Press the Enter key to begin.
5. The following screen will appear:

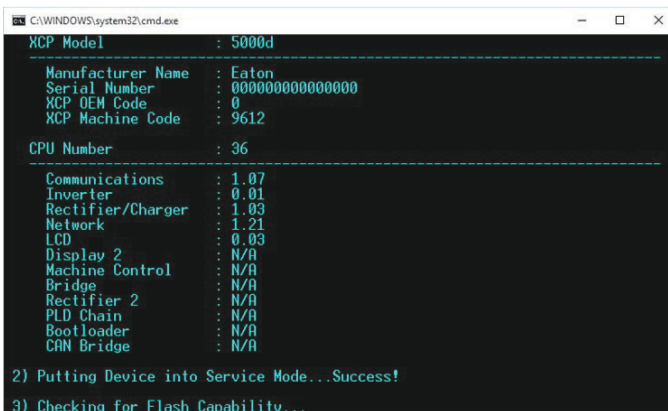

**Figure 81. Installation Start**

6. The flash programming will begin.



```

C:\WINDOWS\system32\cmd.exe
-----
Responding CPU 36 = CPU #36
-----
Memory | Type | Start | Size | Block | Size
-----
4) Reading ROM File...Success!
ROM File      : "Cardinal_Upm1_1_3_25_9.ROM"
-----
Code Version  : 0.01
File Date     : 4/27/2018
Target Name   : Unknown
Target Model # : 9611
Target Module # : 3
Module to Program : Rectifier/Charger
ROM Data Bytes : 217222
Header Size   : 20 Bytes
Load Address  : 00600000
Checksum      : OK

5) Starting Flash Data Programming...

```

**Figure 82. Flash Data**

7. The programming address will increment as the UPM is being programmed

```

C:\WINDOWS\system32\cmd.exe
-----
Responding CPU 36 = CPU #36
-----
Memory | Type | Start | Size | Block | Size
-----
4) Reading ROM File...Success!
ROM File      : "Cardinal_Upm1_1_3_25_9.ROM"
-----
Code Version  : 0.01
File Date     : 4/27/2018
Target Name   : Unknown
Target Model # : 9611
Target Module # : 3
Module to Program : Rectifier/Charger
ROM Data Bytes : 217222
Header Size   : 20 Bytes
Load Address  : 00600000
Checksum      : OK

5) Starting Flash Data Programming...
Programming Address: 0060C800

```

**Figure 83. Programming Address**

8. When finished, the following screen will appear:

```

C:\WINDOWS\system32\cmd.exe
-----
ROM File      : "Cardinal_Upm1_1_3_25_9.ROM"
-----
Code Version  : 0.01
File Date     : 4/27/2018
Target Name   : Unknown
Target Model # : 9611
Target Module # : 3
Module to Program : Rectifier/Charger
ROM Data Bytes : 217222
Header Size   : 20 Bytes
Load Address  : 00600000
Checksum      : OK

5) Starting Flash Data Programming...
Programming Address: 00635080
Programming Success!

6) Sending reset command to Device...

eFlash completed with exit code = 0 (0x0000)
Press any key to continue . . . .

```

**Figure 84. Flash Data Complete**

9. Press any key to continue.
10. The main menu will reappear. UPM - EBM/Supercharger firmware upgrade complete.

This page intentionally left blank.

## Chapter 10 Specifications

This section provides the following specifications for the Eaton 9PXM models:

- Nominal Electrical Input and Output
- Combined UPM Power Ratings
- Circuit Breakers
- Environmental and Safety
- Battery
- Output Run Times
- Weights and Dimensions

### Nominal Electrical Input and Output

**Table 8. Electrical Input and Output**

<b>Nominal Input Voltage</b>	110/220, 120/208, 120/240, 127/220 Vac
<b>Input Voltage Range</b>	80V–144V (Line neutral)
<b>Nominal Output Voltage</b>	110/220, 120/208, 120/240, 127/220 Vac
<b>Nominal Frequency</b>	Online: 60 Hz auto-sensing; output frequency tracks input frequency to selectable limit ( $\pm 0.1$ to $\pm 5.0$ Hz; $\pm 3.0$ Hz default); switches to battery operation outside this tolerance On battery: 60 Hz $\pm 0.1$ Hz
<b>Regulation</b>	$\pm 5\%$ load regulation (under any line, load, or battery condition)
<b>Voltage Waveform</b>	Sine wave; $< 5\%$ THD at rated linear loads, computer-grade power
<b>Overload Capability</b>	115% for 3 seconds; $> 115\%$ for 12 cycles
<b>DC Input Protection</b>	DC fuse
<b>Output Protection</b>	Microprocessor-sensed overvoltage and overcurrent, with fuse backup
<b>Efficiency in Double-Conversion mode</b>	$> 93\%$

### Combined UPM Power Ratings

**Table 9. Power Ratings**

Combined UPM Ratings	Split Phase Voltage L-N/L-L	Max Input Current/Phase	Output Current*	Input Service	Heat Dissipation - Normal Mode
4KVA, 3600 Watts (1UPM)	120/208V or 240V	20	16.67A/phase	25A	850 BTU/hr
8KVA, 7200 Watts (2 UPMs)	120/208V or 240V	40	16.67A/phase	50A	1700 BTU/hr
12KVA, 10800 Watts (3 UPMs)	120/208V or 240V	60	16.67A/phase	75A	2500 BTU/hr
16KVA, 14400 Watts (4 UPMs)	120/208V or 240V	80	16.67A/phase	100A	3400 BTU/hr
20KVA, 18000 Watts (5 UPMs)	120/208V or 240V	100	16.67A/phase	125A	4250 BTU/hr

\*Note: Relative to output load factor

## Circuit Breakers

**Table 10. Circuit Breaker Ratings**

Required Input Circuit Breaker Sizes	
UPS Capacity	Input Circuit Breaker Rating
4KVA	25A
8KVA	50A
12KVA	75A
16KVA	100A
20KVA	125A

## Environmental and Safety

**Table 11. Environmental and Safety**

<b>Operating Temperature</b>	0°C to 40°C (32°F to 104°F) Optimal battery performance: 25°C (77°F)
<b>Storage Temperature</b>	UPS with battery modules: -20°C to +40°C (-4°F to 104°F) UPS without batteries: -40°C to +60°C (-40°F to 140°F)
<b>Relative Humidity</b>	5–95% noncondensing
<b>Operating Altitude</b>	Up to 3,050 meters above sea level (10,000 ft) The maximum operating ambient temperature decreases 1°C per 300m above 1525m (2°F per 1000 ft above 5000 ft)
<b>Non-Operating Altitude</b>	Up to 12,200m above sea level (40,000 ft)
<b>Ventilation</b>	The air around the UPS must be clean and free of dust, corrosive chemicals, and other contaminants. The Eaton 9PXM UPS uses internal fans to circulate the air for cooling. The air must be free to circulate around the UPS and battery cabinet(s). Do not operate the UPS in a sealed room or container.
<b>Audible Noise</b>	Less than 67 dBA
<b>Surge Suppression</b>	EN 61000-4-5
<b>Safety Conformance</b>	CSA C22.2, No. 107.3; UL1778 5th Edition
<b>Agency Markings</b>	NOM, UL, CUL, FCC
<b>EMC (Class A)</b>	EN 62040-2, FCC Part 15, EN 61000-4-2 level 3 Criteria B, EN 61000-4-3 level 3 Criteria A, EN 61000-4-4, 61000-4-5, 61000-4-6, 61000-4-8

### Battery Ratings

**Table 12. Battery Ratings**

<b>Configuration</b>	(2) 60V, 9 Ah battery modules per two-battery slot
<b>Voltage</b>	120 Vdc
<b>Type</b>	Sealed, maintenance-free, valve-regulated, lead-acid
<b>Charging</b>	ABM recommends 48 hours of charging after a discharge. Optional super chargers at higher current ratings are available.

### Output Run Times

**Table 13. Electrical Input and Output - Model Run Times**

Model	Nominal Output Voltage (VAC) L-N /L-L	Output VA/W Rating @ Nominal Voltage	Input Connection	Output (See Output Receptacles Figure 85)	Minimum Run time at full power load**
<b>Split-Phase 20kVA 12-Slot Model</b>	110/220	18000/16200	Hardwired	Hardwired + Optional Receptacles	5.8 min
	120/208	20000/18000			
	120/240	20000/18000			
	127/220	20000/18000			
<b>Split-Phase 16kVA 8-Slot Model</b>	110/220	16000/14400	Hardwired	Hardwired + Optional Receptacles	5.8 min
	120/208				
	120/240				
	127/220				

\* The bypass is rated twice the power rating of a UPM in order to support load if one UPM were to fail.

\*\* With one two-battery slot/one power module (One two-battery slot = two battery modules in one slot).

### Weights and Dimensions

**Table 14. Weights and Dimensions**

Cabinet Size	Package Height	Package Length	Package Width	Package Weight	Product Height	Product Length	Product Width	Product Weight	With Caster Tray (lbs)
12 Slot UPS	118.1 cm (46.5")	88.9 cm (35")	64.1 cm (25.25")	110.7 kg (244 lb)	92.7 cm (36.5")	87.6 cm (34.5")	44.5 cm (17.5")	77.1 kg (170 lb)	93.4 kg (206 lb)
8 Slot UPS	88.9 cm (35")	88.9 cm (35")	64.1 cm (25.5")	90.3 kg (199 lb)	63.5 cm (25")	87.6 cm (34.5")	44.5 cm (17.5")	56.7 kg (125 lb)	73 kg (161 lb)
12 Slot EBM	118.1 cm (46.5")	88.9 cm (35")	64.1 cm (25.5")	108.5 kg (239 lb)	92.7 cm (36.5")	87.6 cm (34.5")	44.5 cm (17.5")	74.8 kg (165 lb)	91.2 kg (201 lb)
8 Slot EBM	88.9 cm (35")	88.9 cm (35")	64.1 cm (25.5")	88 kg (194 lb)	63.5 cm (25")	87.6 cm (34.5")	44.5 cm (17.5")	54.4 kg (120 lb)	70.8 kg (156 lb)
Battery Module	16.5 cm (6.5")	64.8 cm (25.5")	30.5 cm (12")	15.9 kg (35 lb)	7.6 cm (3")	54.6 cm (21.5")	21.6 cm (8.5")	15 kg (33 lb)	N/A
Split Phase Power module	29.2 cm (11.5")	68.6 cm (27.5")	38.1 cm (15")	15.4 kg (34 lb)	15.2 cm (6")	58.4 cm (23")	21.6 cm (8.5")	12 kg (26.5 lb)	N/A
Super Charger	29.2 cm (11.5")	68.6 cm (27.5")	38.1 cm (15")	12.5 kg (27.5 lb)	15.2 cm (6")	58.4 cm (23")	21.6 cm (8.5")	10.2 kg (22.5 lb)	N/A

**Table 14. Weights and Dimensions (Continued)**

Cabinet Size	Package Height	Package Length	Package Width	Package Weight	Product Height	Product Length	Product Width	Product Weight	With Caster Tray (lbs)
Rail Kit	26.7 cm (10.5")	101.6 cm (40")	61 cm (24")	27.4 kg (60.5 lb)	14 cm (5.5")	58.4 cm (23")	49.5 cm (19.5")	15.6 kg (34.5 lb)	N/A
Caster	25.4 cm (10")	101.6 cm (40")	61 cm (24")	28.1 kg (62 lb)	12.7 cm (5")	73.7 cm (29")	50.8 cm (20")	16.3 kg (36 lb)	N/A
Floor anchor kit	20.3 (8")	25.4 cm (10")	15.2 kg (6")	4.1 kg (9 lb)	12.7 cm (5")	12.7 cm (5")	7.6 cm (3")	3.6 kg (8 lb)	N/A

**Output Receptacles**

Figure 85 shows the types of compatible output receptacles.

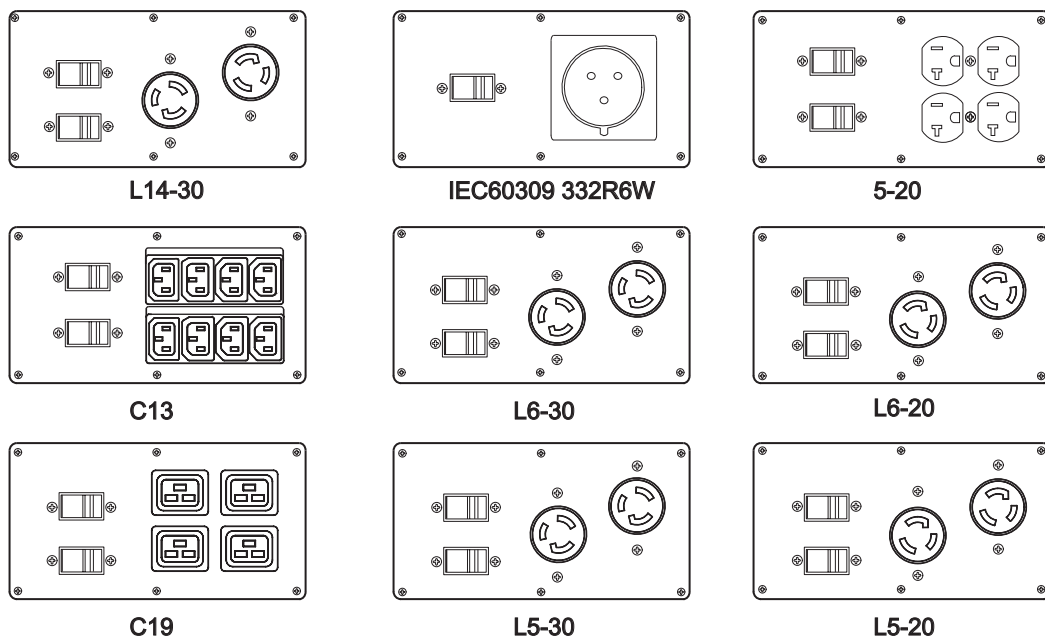

**Figure 85. Compatible Output Receptacles**

**Receptacle Circuit Breakers**

**Table 15. Receptacle Circuit Breaker Ratings**

Receptacle Panel	Circuit Breaker	Quantity per Panel
5-20	1 Pole 20 Amp	2
IEC60309	2 Pole 30 Amp	1
C13	2 Pole 20 Amp	2
C19	2 Pole 30 Amp	2
L14-30	2 Pole 30 Amp	2
L5-20	1 Pole 20 Amp	2
L5-30	1 Pole 30 Amp	2
L6-20	2 Pole 20 Amp	2
L6-30	2 Pole 30 Amp	2

## Chapter 11 Troubleshooting

### Troubleshooting

The Eaton 9PXM is designed for durable, automatic operation and also alert you whenever potential operating problems may occur. Usually the alarms shown by the control panel do not mean that the output power is affected. Instead, they are preventive alarms intended to alert the user.

- Events are silent status information that are recorded into the Event log. Example = "AC freq in range".
- Alarms are recorded into the Event log and displayed on the LCD status screen with the logo blinking. Some alarms may be announced by a beep every 3 seconds. Example = "Battery low".
- Faults are announced by a continuous beep and red LED, recorded into the Fault log and displayed on the LCD with a specific message box. Example = Out. short circuit.

Use the following troubleshooting chart to determine the UPS alarm condition.

#### Typical Alarms and Faults

To check the Event log or Fault log:

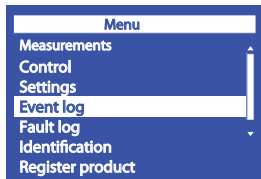

1. Press any button on the front panel display to activate the menu options.
2. Press the ↓ button to select Event log or Fault log from the Menu screen.







**Figure 86. Event Log Menu**

3. Scroll through the listed events or faults.

The following table describes typical conditions.

	Possible Cause Conditions	Action
Battery mode  LED is On 1 beep every 10 seconds	A utility failure has occurred and the UPS is on Battery mode.	The UPS is powering the equipment with the battery power. Prepare your equipment for shutdown.
Battery low  LED is On 1 beep every 3 seconds	The UPS is in Battery mode and the battery is running low.	This warning is approximate, and the actual time to shutdown may vary significantly. Depending on the UPS load and number of Extended Battery Modules (EBMs), the "Battery Low" warning may occur before the batteries reaches low capacity.
No Battery  LED is On. Beep continuous.	The batteries are disconnected.	Verify that all batteries are properly connected. If the condition persists, contact your service representative.

	Possible Cause Conditions	Action
Battery fault  LED is On. Beep continuous.	The battery test is failed due to bad or disconnected batteries, or the battery minimum voltage is reached in ABM cycling mode.	Verify that all batteries are properly connected. Start a new battery test: if the condition persists, contact your service representative.
The UPS does not provide the expected backup time.	The batteries need charging or service.	Apply utility power for 48 hours to charge the batteries. If the condition persists, contact your service representative.
Bypass Mode  LED is On.	An overload or a fault has occurred, or a command has been received and the UPS is in Bypass mode	Equipment is powered but not protected by the UPS.  Check for one of the following alarms: overtemperature, overload or UPS LED is on failure.
Power Overload  LED is On. Beep continuous.	Power requirements exceed the UPS capacity (greater than 100% of nominal; see in Table 8 on page 87 for specific output overload ranges).	Remove some of the equipment from the UPS. The UPS continues to operate, but may switch to Bypass mode or shut down if the load increases. The alarm resets when the condition becomes inactive.
UPS Overtemperature  LED is On. 1 beep every 3 seconds.	The UPS internal temperature is too high or a fan has failed. At the warning level, the UPS generates the alarm but remains in the current operating state. If the temperature rises another 5°C, the UPS transfers to Bypass mode or shuts down if Bypass is unusable.	If the UPS transferred to Bypass mode, the UPS will return to normal operation when the temperature drops 5°C below the warning level. If the condition persists, shut down the UPS.  Clear vents and remove any heat sources. Allow the UPS to cool. Ensure the airflow around the UPS is not restricted. Restart the UPS. If the condition continues to persist, contact your service representative.
The UPS does not start.	A utility failure has occurred.	Contact a qualified electrician.
	The Remote Power Off (RPO) switch is active or the RPO connector is missing.	If the UPS Status menu displays the "Remote Power Off" notice, inactivate the RPO input.

### Silencing the Alarm



Press the ESC (Escape) button on the front panel display to mute the alarm. Check the alarm condition and perform the applicable action to resolve the condition. If the alarm status changes, the alarm beeps again, overriding the previous alarm muting.



## Frequently Asked Questions

The following table provides answers to commonly asked questions.

**Table 16. Frequently Asked Questions**

Question: How do I...	Answer
Turn the UPS on?	<p>Verify that all power modules are securely plugged into the cabinet, and each module secured in it's slot.</p> <p>If external battery cabinets are installed, confirm that the DC emergency disconnect switch button on the back of the cabinet is closed (pulled out). To close the DC emergency disconnect switch button, insert the switch key supplied with the cabinet into the button and turn clockwise 1/2-turn. Pull the button out to close the switch. Turn the key back counter-clockwise, and remove the key.</p> <p>If an external bypass switch is installed, turn the switch to the LINE or UPS position.</p> <p>Refer to the front panel display and press the button labeled ON. (If On/Off control is password-protected, enter your password. Confirm the selection by pressing the button labeled Yes. After a few seconds, the green LED illuminates to signal the UPS is operating and producing power.</p>
Turn the UPS off?	<p>Refer to the front panel display and press the button labeled OFF. Confirm the selection by pressing the button labeled Yes. (If On/Off control is password-protected, enter your password.</p>
Turn off the alarm beeps?	<p>Press the lower left button on the front panel display. Note the alarm message and see "Typical Alarms and Faults" on page 91 to correct the problem. After the problem has been resolved, press the lower center button to clear the alarm.</p>
View the alarm log?	<p>Go to the menus in Figure 61 on page 69. Press  the button to view the most recent alarm. Press the  button to scroll down through the log to view previous alarms.</p>
Check the input or output voltage?	<p>Go to the menus in Figure 52 on page 61 to select the input and output voltages.</p>
Check the battery voltage?	<p>Go to menu in Figure 52 on page 61 To view other system status parameters</p>
Check the condition of the batteries?	<p>The results of the most recent battery test are stored in the battery menu in Figure 52 on page 61. To run a test of battery condition, go to menu in Figure 53 on page 62 and press the  button. When the test is complete, the results are again stored in the Battery Results parameter.</p>
Apply power to the load if the unit will not operate?	<p>Turn the optional external bypass switch to either the SERVICE or the LINE position. In these two positions, utility power flows directly to the load. In the SERVICE position, the UPS does not receive utility power and may be worked on for maintenance purposes.</p>
Turn the external bypass switch?	<p>You must press the red button beside the switch before turning the switch.</p>
Set the UPS to turn on in High Efficiency mode?	<p>From the In\Out settings menu select High Efficiency mode then select Enabled (see Chapter 7, "In/Out Settings Menu" on page 64)</p>
Change the level of system redundancy?	<p>To view or change the redundancy level, go to the menu in Figure 55 on page 64.</p>
Change the batteries?	<p>Each pair of battery modules of a two-battery slot forms one series slot on the battery bus. See "Battery Replacement" on page 75 for the battery replacement procedure.</p>
Add/delete one or more slots of batteries?	<p>Physically install or remove battery modules as described in "Battery Replacement" on page 75. If not using a 9PXM EBM, record the capacity of external battery slots (in all external battery cabinets) by going to menu Figure 52 on page 61</p>
Add/delete one or more power modules?	<p>Physically install or remove power modules as described in "Power Module Replacement" on page 76. The system operating software senses the number and location of all power modules in the cabinet. If you want to change the number of redundant power modules, go to menu in Figure 55 on page 64 and change the level of system redundancy.</p>

### Service and Support

If you have any questions or problems with the UPS, call your **Local Distributor** or the **Help Desk** at one of the following telephone numbers and ask for a UPS technical representative.

United States: **1-800-356-5737**  
Canada: **1-800-461-9166 ext 260**  
All other countries: **Call your local service representative**

Please have the following information ready when you call the Help Desk:

- Model number
- Serial number
- Version number (if available)
- Date of failure or problem
- Symptoms of failure or problem
- Customer return address and contact information

If repair is required, you will be given a Returned Material Authorization (RMA) Number. This number must appear on the outside of the package and on the Bill Of Lading (if applicable). Use the original packaging or request packaging from the Help Desk or distributor. Units damaged in shipment as a result of improper packaging are not covered under warranty. A replacement or repair unit will be shipped, freight prepaid for all warrantied units.

**NOTE**

For critical applications, immediate replacement may be available. Call the **Help Desk** for the dealer or distributor nearest you.

---

## Chapter 12 Warranty

### Two-Year Limited Warranty (US and Canada)

#### **Eaton UPS Model: 9PXM**

**WARRANTOR:** The warrantor for the limited warranties set forth herein is Eaton (“Company”).

**LIMITED WARRANTY:** This limited warranty (this “Warranty”) applies only to the original End-user (the “End-user”) of any 9PXM product purchased on or after June 1, 2004, and cannot be transferred. This Warranty applies even in the event that the Product is initially sold by Company for resale to an End-user.

**LIMITED WARRANTY PERIOD:** The period covered by this Warranty for Product installed [and currently located] in the fifty (50) United States, the District of Columbia and Canada is twenty-four (24) months from the date of purchase, or thirty (30) months from the date of shipment.

**WHAT THIS LIMITED WARRANTY COVERS:** The warrantor warrants that the Product and battery (individually and collectively, the “Warranted Items”) are free of defects in material and workmanship. If, in the opinion of Company, a Warranted Item is defective and the defect is within the terms of this Warranty, Company’s sole obligation will be to repair or replace such defective Warranted Item (including by providing service, parts and labor, as applicable), at the option of Company.

**PROCEDURES FOR REPAIR OR REPLACEMENT OF WARRANTED ITEMS:** The Warranted Item will be repaired or replaced at a Company site or such other location as determined by Company.

If the Warranted Item is to be replaced by Company, and the End-user supplies a credit card number or purchase order for the value of the replacement product, Company will use commercially reasonable business efforts to ship (via standard ground shipment and at no cost to the End-user) the replacement Warranted Item to the End-user within one (1) business day after Company receives notice of the warranty claim. In such case, the End-user must return (at Company’s expense) the defective Warranted Item to Company in the same packaging as the replacement Warranted Item received by the End-user or as otherwise instructed by Company. If Company does not receive the defective Warranted Item, Company will either charge the End-user’s credit card, or send the End-user an invoice (which the End-user agrees to pay), for the value of the replacement product.

If the Warranted Item is to be replaced by Company, but the End-user is unwilling or unable to supply a credit card number or purchase order for the value of the replacement product, Company will use commercially reasonable business efforts to ship (via standard ground shipment and at no cost to the End-user) the replacement Warranted Item to the End-user within one (1) business day after Company receives the defective product from the End-user.

In any case, Company will provide shipping instructions and will pay its designated carrier for all shipping charges for return of defective equipment and replacement of Warranted Items. Any returned Warranted Item or parts that are replaced may be new or reconditioned. All Warranted Items returned to Company and all parts replaced by Company shall become the property of Company.

**WHAT THIS LIMITED WARRANTY DOES NOT COVER:** This Warranty does not cover any defects or damages caused by: (a) failure to properly store the Product before installation, including the charge of batteries no later than the date indicated on the packaging; (b) shipping and delivery of the Product if shipping is FOB Factory; (c) neglect, accident, abuse, misuse, misapplication or incorrect installation; (d) repair or alteration not authorized in writing by Company personnel or performed by an authorized Company Customer Service Engineer or Agent; (e) improper testing, operation, maintenance, adjustment or modification of any kind not authorized in writing by Company personnel or performed by an authorized Company Customer Service Engineer or Agent; or (f) use of the Product under other than normal operating conditions or in a manner inconsistent with the Product’s labels or instructions.

This Warranty is not valid if the Product's serial numbers have been removed or are illegible. Any Warranted Items repaired or replaced pursuant to this Warranty will be warranted for the remaining portion of the original Warranty subject to all the terms thereof.

Company shall not be responsible for any charges for testing, checking, removal or installation of Warranted Items.

**COMPANY DOES NOT WARRANT EQUIPMENT NOT MANUFACTURED BY COMPANY. IF PERMITTED BY THE APPLICABLE MANUFACTURER, COMPANY SHALL PASS THROUGH SUCH MANUFACTURER'S WARRANTIES TO END-USER.**

**COMPANY DOES NOT WARRANT SOFTWARE, INCLUDING SOFTWARE EMBEDDED IN PRODUCTS, THAT IS NOT CREATED BY COMPANY. WITHOUT LIMITING THE FOREGOING, COMPANY SPECIFICALLY DOES NOT WARRANT SOFTWARE (SUCH AS LINUX) THAT WAS CREATED USING AN "OPEN SOURCE" MODEL OR IS DISTRIBUTED PURSUANT TO AN OPEN SOURCE LICENSE.**

**THIS WARRANTY IS THE SOLE AND EXCLUSIVE WARRANTY OFFERED BY COMPANY WITH RESPECT TO THE PRODUCTS AND SERVICES AND, EXCEPT FOR SUCH FOREGOING WARRANTY COMPANY DISCLAIMS ALL OTHER WARRANTIES INCLUDING BUT NOT LIMITED TO ANY IMPLIED WARRANTIES OF MERCHANTABILITY, TITLE, NON-INFRINGEMENT AND FITNESS FOR A PARTICULAR PURPOSE. CORRECTION OF NON-CONFORMITIES IN THE MANNER AND FOR THE PERIOD OF TIME PROVIDED ABOVE SHALL CONSTITUTE COMPANY'S SOLE LIABILITY AND END-USER'S EXCLUSIVE REMEDY FOR FAILURE OF COMPANY TO MEET ITS WARRANTY OBLIGATIONS, WHETHER CLAIMS OF THE END-USER ARE BASED IN CONTRACT, IN TORT (INCLUDING NEGLIGENCE OR STRICT LIABILITY), OR OTHERWISE.**

**LIMITATION OF LIABILITY:** The remedies of the End-user set forth herein are exclusive and are the sole remedies for any failure of Company to comply with its obligations hereunder. In no event shall Company be liable in contract, in tort (including negligence or strict liability) or otherwise for damage to property or equipment other than the Products, including loss of profits or revenue, loss of use of Products, loss of data, cost of capital, claims of customers of the End-user or any special, indirect, incidental or consequential damages whatsoever. The total cumulative liability of Company hereunder whether the claims are based in contract (including indemnity), in tort (including negligence or strict liability) or otherwise, shall not exceed the price of the Product on which such liability is based.

Company shall not be responsible for failure to provide service or parts due to causes beyond Company's reasonable control.

**END-USER'S OBLIGATIONS:** In order to receive the benefits of this Warranty, the End-user must use the Product in a normal way; follow the Product's operation and maintenance manual; and protect against further damage to the Product if there is a covered defect.

**OTHER LIMITATIONS:** Company's obligations under this Warranty are expressly conditioned upon receipt by Company of all payments due to it (including interest charges, if any). During such time as Company has not received payment of any amount due to it for the Product, in accordance with the contract terms under which the Product is sold, Company shall have no obligation under this Warranty. Also during such time, the period of this Warranty shall continue to run and the expiration of this Warranty shall not be extended upon payment of any overdue or unpaid amounts.

**COSTS NOT RELATED TO WARRANTY:** The End-user shall be invoiced for, and shall pay for, all services not expressly provided for by the terms of this Warranty, including without limitation, site calls involving an inspection that determines no corrective maintenance is required. Any costs for replacement equipment, installation, materials, freight charges, travel expenses or labor of Company representatives outside the terms of this Warranty will be borne by the End-user.

**OBTAINING WARRANTY SERVICE:** In the USA, call the Customer Reliability Center 7x24 at 800-356-5737. Outside of the USA, contact your local Eaton product sales or service representative for units purchased from those countries, or call the Customer Reliability Center in the USA at 919-845-3683 for units purchased in the USA that were shipped overseas. For comments or questions about this Warranty, write to the Customer Quality Representative, 8609 Six Forks Road, Raleigh, North Carolina 27615 USA.

## Load Protection Guarantee (US and Canada)

### Eaton UPS Model 9PXM

**GUARANTOR:** The Guarantor for the load protection guaranty set forth herein is Eaton ("Company").

**LIMITED GUARANTY:** This load protection guaranty (this "Guaranty") applies only to the original End-user (the "End-user") of any Eaton 9PXM Product and cannot be transferred. This Guaranty applies even in the event that the Product is initially sold by Company for resale to an End-user.

**WHAT THIS GUARANTY COVERS:** For the lifetime of the Product, Guarantor promises to repair or replace, at Guarantor's option, the equipment (valued up to the limits shown below\*) that is damaged by an AC power line surge, spike, or other transient when properly connected to Guarantor's uninterruptible power system ("UPS"). Reimbursement for or restoration of data loss excluded. This Guaranty applies only if all of the following circumstances arise:

1. The UPS is plugged into properly grounded and wired outlets, using no extension cords, adapters, other ground wires, or other electrical connectors;
2. The installation of the UPS complies with all applicable electrical and safety codes described by the National Electrical Code (NEC);
3. The UPS was used under normal operating conditions and in accordance with all labels and instructions; and
4. The UPS was not damaged by accident (other than AC power line transient), misuse, or abuse.

**\*Cumulative Limits to be paid by Guarantor under this Load Protection Guaranty:**

- \$25,000 for Eaton UPS Model 3105 and 3S
- \$150,000 for Eaton UPS Models 5S, 5SC, 5110, 5115, 5125, 5P, and 5PX
- \$250,000 for Eaton UPS Models 9130, 9135, 9140, 9PX, 9PXM, 9155, 9170+, and FERRUPS products

**WHAT THIS GUARANTY DOES NOT COVER:** Any reimbursement or repair to End-user's equipment does not include reimbursement for or restoration of any data loss. This Guaranty does not cover any defects or damages caused by: (a) failure to properly store the Product before installation, including the charge of batteries no later than the date indicated on the packaging; (b) shipping and delivery of the Product if shipping is FOB Factory; (c) neglect, accident, abuse, misuse, misapplication, or incorrect installation of Product; (d) repair or alteration of Product not authorized in writing by Company personnel or performed by an authorized Company Customer Service Engineer or Agent; (e) improper testing, operation, maintenance, adjustment, or modification of any kind to the Product not authorized in writing by Company personnel or performed by an authorized Company Customer Service Engineer or Agent; or (f) use of the Product under other than normal operating conditions or in a manner inconsistent with the Product's labels or instructions.

**This Guaranty is not valid: (a) unless the End-user returns to Company the Warranty Registration Card or completes the registration form on [www.powerquality.eaton.com/productregistration](http://www.powerquality.eaton.com/productregistration) within thirty (30) days of purchase; or (b) if the Product's serial numbers have been removed or are illegible.**

Company shall not be responsible for any charges for testing, checking, removal, or installation of any items.

**LIMITATION OF LIABILITY:** THE REMEDIES OF THE END-USER SET FORTH HEREIN ARE EXCLUSIVE AND ARE THE SOLE REMEDIES FOR ANY FAILURE OF COMPANY TO COMPLY WITH ITS OBLIGATIONS HEREUNDER. EXCEPT AS OTHERWISE PROVIDED FOR IN THIS GUARANTY, IN NO EVENT SHALL COMPANY BE LIABLE IN CONTRACT, IN TORT (INCLUDING NEGLIGENCE OR STRICT LIABILITY) OR OTHERWISE FOR DAMAGE TO PROPERTY OR EQUIPMENT OTHER THAN THE PRODUCTS, INCLUDING LOSS OF PROFITS OR REVENUE, LOSS OF USE OF PRODUCTS, LOSS OF DATA, COST OF CAPITAL, CLAIMS OF CUSTOMERS OF THE END-USER OR ANY SPECIAL, INDIRECT, INCIDENTAL, OR CONSEQUENTIAL DAMAGES WHATSOEVER. THE TOTAL CUMULATIVE LIABILITY OF COMPANY HEREUNDER WHETHER THE CLAIMS ARE BASED IN CONTRACT (INCLUDING INDEMNITY), IN TORT (INCLUDING NEGLIGENCE OR STRICT LIABILITY) OR OTHERWISE, SHALL NOT EXCEED THOSE SET FORTH ABOVE.

Company shall not be responsible for failure to provide repair or replacement under this Guaranty due to causes beyond Company's reasonable control.

**END-USER'S OBLIGATIONSS:** In order to receive the benefits of this Guaranty, the End-user must use the Product in a normal way; follow the Product's operation and maintenance manual; and protect against further damage to the Product if there is a covered defect.

**OTHER LIMITATIONS:** Company's obligations under this Guaranty are expressly conditioned upon receipt by Company of all payments due to it (including interest charges, if any). During such time as Company has not received payment of any amount due to it for the Product, in accordance with the contract terms under which the Product is sold, Company shall have no obligation under this Guaranty.

**COSTS NOT RELATED TO GUARANTY:** The End-user shall be invoiced for, and shall pay for, all services not expressly provided for by the terms of this Guaranty, including without limitation, site calls involving an inspection that determines no corrective maintenance is required. Any costs for replacement equipment, installation, materials, freight charges, travel expenses, or labor of Company representatives outside the terms of this Guaranty will be borne by the End-user.

**TO MAKE A CLAIM:** In the USA, call the Customer Reliability Center 7x24 at 800-356-5737. Outside of the USA, contact your local Eaton product sales or service representative for units purchased from those countries, or call the Customer Reliability Center in the USA at 919-845-3683 for units purchased in the USA that were shipped overseas. For comments or questions about this Load Protection Guaranty, write to the Customer Quality Representative, 8609 Six Forks Road, Raleigh, North Carolina 27615 USA.





P-164000669 6