

**FIRSTLINE P<sub>LT</sub>**  
**FIRSTLINE P<sub>LT</sub> 924**  
208-480V 60Hz  
10 to 60kVA  
**USER MANUAL**

Staco Energy is highly specialized in the development and production of uninterruptible power systems (UPS). The UPS's of this series are high quality products, carefully designed and manufactured to ensure optimum performance.

No reproduction of any part of this manual, even partial, is permitted without the authorization of Staco Energy Products Company. The Staco Energy Products Company reserves the right to modify the product described herein, in order to improve it, at any time and without notice.

301 Gaddis Boulevard • Dayton, Ohio 45403  
U.S. Toll Free 866-261-1191  
(937) 253-1191 • Fax: (937) 253-1723  
Web site: [www.stacoenergy.com](http://www.stacoenergy.com)

*Thank you for choosing our product.*

**Applicability  
Standard Models**

F L P - 0 XX T - 1 - XX-YY - ZZZ

**Separate Bypass Input**

**Blank:** None

**2DB:** 208V Isolation Transformer. Only on Models with "2D-2Y"

**2YB:** 208/120V No Transformer. Only on Models with "2Y-4Y"

**4DB:** 480V Isolation Transformer. Only on Models with "4D-2Y"

**4YB:** 480/277V Autotransformer. Only on Models with "4Y-2Y"

**Input/Output Transformer & Battery #2**

**Blank:** Battery String 2 and Transformers NOT Provided

**"-0":** Battery Shelf Provided for String 2, Batteries and trays NOT included. Transformers NOT Provided

**"-1":** 90W/23Ah Battery String 2 Provided\*. Transformers NOT Provided.

**"-2":** 51W/13Ah Battery String 2 Provided\*. Transformers NOT Provided.

**"-3":** 34W/8Ah Battery String 2 Provided\*. Transformers NOT Provided.

**"2D-2Y"** – Battery String 2 NOT Provided. Includes 208V Input Isolation Transformer and 208/120V Output NO Transformer

**"2D-4Y"** – Battery String 2 NOT Provided. Includes 208V Input Isolation Transformer and 480/277V Output Autotransformer

**"2Y-4Y"** – Battery String 2 NOT Provided. Includes 208/120V Input NO Transformer and 480/277V Output Autotransformer.

**"4D-2Y"** – Battery String 2 NOT Provided. Includes 480V Input Isolation Transformer and no Output Transformer.

**"4D-4Y"** – Battery String 2 NOT Provided. Includes 480V Input Isolation Transformer and 480/277V Output Autotransformer.

**"4Y-2Y"** – Battery String 2 NOT Provided. Includes 480/277V Input Autotransformer and 208/120V Output NO Transformer

**"4Y-4Y"** – Battery String 2 NOT Provided. Includes 480/277V Input Autotransformer and 480/277V Output Autotransformer.

**Battery String #1**

**"-0"** – Battery Shelf provided, but batteries and battery trays not Included

**"-1"** – 90W/23Ah battery string\*

**"-2"** – 51W/13Ah battery string\*

**"-3"** – 34W/8Ah battery string\*

**KVA and Cabinet type**

**"-060T"** – 60 kVA Tall

**"-050T"** – 50 kVA Tall

**"-040T"** – 40 kVA Tall

**"-030T"** – 30 kVA Tall

**"-020T"** – 20 kVA Tall

**"-015T"** – 15 kVA Tall

**"-010T"** – 10 kVA Tall

**Series**

FLP: FirstLine PL

\*not available in 50/60kVA units

## UL924 Models

FLP - 924 - 36T - 4Y-4Y

### Input/Output Transformer

Blank: Transformers NOT Provided

"2D-2Y" – Battery String 2 NOT Provided. Includes 208V Input Isolation Transformer and 208/120V Output NO Transformer

"2D-4Y" – Battery String 2 NOT Provided. Includes 208V Input Isolation Transformer and 480/277V Output Autotransformer

"2Y-4Y" – Battery String 2 NOT Provided. Includes 208/120V Input NO Transformer and 480/277V Output Autotransformer..

"4D-2Y" – Battery String 2 NOT Provided. Includes 480V Input Isolation Transformer and no Output Transformer.

"4D-4Y" – Battery String 2 NOT Provided. Includes 480V Input Isolation Transformer and 480/277V Output Autotransformer.

"4Y-2Y" – Battery String 2 NOT Provided. Includes 480/277V Input Autotransformer and 208/120V Output NO Transformer

"4Y-4Y" – Battery String 2 NOT Provided. Includes 480/277V Input Autotransformer and 480/277V Output Autotransformer.

### KVA and Cabinet type

"54T" – 60 kVA Tall

"45T" – 50 kVA Tall

"36T" – 40 kVA Tall

"27T" – 30 kVA Tall

"18T" – 20 kVA Tall

"13T" – 15 kVA Tall

"09T" – 10 kVA Tall

### UL Standard

"924" – UL924 System

### Series

FLP: FirstLine PL

## UL924 OUST Models

FLP-924-36T-0-4Y-4Y-A

### Separate Bypass Input / UL924 OUST Options

**A:** OUST Unit with no bypass transformer

**2DA:** 208V Isolation Transformer. Only on Models with "2D-2Y"

**2YA:** 208/120V No Transformer. Only on Models with "2Y-4Y"

**4DA:** 480V Isolation Transformer. Only on Models with "4D-2Y"

**4YA:** 480/277V Autotransformer. Only on Models with "4Y-2Y"

### Internal Input/Output Transformer or Internal Battery #2

**Blank:** Battery String 2 and Transformers NOT Provided

**"-0":** Battery Shelf Provided for String 2, Batteries and trays NOT included. Transformers NOT Provided

**"-1":** 90W/23Ah Battery String 2 Provided. Transformers NOT Provided.

**"-2":** 51W/13Ah Battery String 2 Provided. Transformers NOT Provided.

**"-3":** 34W/8Ah Battery String 2 Provided. Transformers NOT Provided.

**"2D-2Y"** – Battery String 2 NOT Provided. Includes 208V Input Isolation Transformer and 208/120V Output NO Transformer

**"2D-4Y"** – Battery String 2 NOT Provided. Includes 208V Input Isolation Transformer and 480/277V Output Autotransformer

**"2Y-4Y"** – Battery String 2 NOT Provided. Includes 208/120V Input NO Transformer and 480/277V Output Autotransformer.

**"4D-2Y"** – Battery String 2 NOT Provided. Includes 480V Input Isolation Transformer and no Output Transformer.

**"4D-4Y"** – Battery String 2 NOT Provided. Includes 480V Input Isolation Transformer and 480/277V Output Autotransformer.

**"4Y-2Y"** – Battery String 2 NOT Provided. Includes 480/277V Input Autotransformer and 208/120V Output NO Transformer

**"4Y-4Y"** – Battery String 2 NOT Provided. Includes 480/277V Input Autotransformer and 480/277V Output Autotransformer.

### Internal Battery String #1

**"-0"** – Battery Shelf provided, but batteries and battery trays not Included

**"-1"** – 90W/23Ah battery string\*

**"-2"** – 51W/13Ah battery string\*

**"-3"** – 34W/8Ah battery string\*

### KVA and Cabinet type

**"54T"** – 60 kVA Tall

**"45T"** – 50 kVA Tall

**"36T"** – 40 kVA Tall

**"27T"** – 30 kVA Tall

**"18T"** – 20 kVA Tall

**"13T"** – 15 kVA Tall

**"09T"** – 10 kVA Tall

### UL Standard

**"924"** – UL924 System

### Series

**FLP:** FirstLine PL

\*not available in 50/60kVA units

## Safety Warnings



### **IMPORTANT SAFETY INSTRUCTIONS SAVE THESE INSTRUCTIONS**

This manual contains important instructions for Models 10 - 60kVA FIRSTLINE PLT series UPS that should be followed during installation and maintenance of the UPS. Please read all instructions before operating the UPS and save this manual for future reference.

#### **READ AND FOLLOW ALL SAFETY INSTRUCTIONS**

- a. Do not use outdoors.
- b. Do not route wiring across or near hot surfaces.
- c. Do not install near gas or electric heaters.
- d. Use caution when servicing batteries. Battery acid can cause burns to skin and eyes. If acid is spilled on skin or in eyes, flush acid with fresh water and contact a physician immediately.
- e. Unit should be installed where it will not readily be subjected to tampering by unauthorized personnel.
- f. The use of accessory equipment not recommended by the manufacturer may cause an unsafe condition.
- g. Do not use this UPS for other than intended use.

## DANGER



This UPS contains LETHAL VOLTAGES. All repairs and service should be performed by AUTHORIZED SERVICE PERSONNEL ONLY. There are NO USER SERVICEABLE PARTS inside the UPS.

## WARNING



To reduce the risk of fire or electric shock, install this UPS in a temperature and humidity controlled, indoor environment, free of conductive contaminants. Do not operate near water or excessive humidity.

## WARNING



Input and output over-current protection and disconnect switches must be provided by others.

High ground leakage current may be present. Do not operate the unit without a proper protective ground.

## WARNING



Batteries can present a risk of electrical shock or burn from high short circuit current. Observe proper precautions. Servicing should be performed by qualified service personnel knowledgeable of batteries and required precautions. Keep unauthorized personnel away from batteries.

There is a risk of explosion if batteries are replaced by an incorrect type. Replace with same type and rating only.

Proper disposal of batteries is required. Refer to your local codes for disposal requirements.

Never dispose of batteries in a fire

This product is available with internal batteries installed. When storing this product for more than 30 days it is recommended that the internal battery be disconnected. See **2.2.2 Storage** and **6.2 Internal Battery Replacement** for instructions to disconnect the internal battery, and more details on long term battery storage.

## **Emergency Interventions**

The following information is of a general nature.

### **First aid interventions**



Company regulations and traditional procedures should be followed for any first aid intervention that may be required.

### **Firefighting measures**

1. Do not use water to put out a fire, but only fire extinguishers that are suitable for use with electrical and electronic equipment.
2. If exposed to heat or fire, some products may release toxic fumes into the atmosphere. Always use a respirator when extinguishing a fire.

### **Symbols used in the Manual**

In this manual, some operations are shown by graphic symbols to alert the reader to the dangerous nature of the operations:





	<b>Danger / Risk of Electric Shock</b> <i>This symbol indicates possibility of serious injury or substantial damage to the unit, unless adequate precautions are taken.</i>
	<b>Warning</b> <i>This symbol indicates important information which must be understood and any stated precautions taken</i>
	<b>Note</b>



### Protective Equipment

No maintenance operations shall be carried out on the unit without wearing the Personal Protective Equipment (PPE) described below. Personnel involved in the installation or maintenance of the unit must be properly clothed.

The following signs show the protective equipment that should be worn. The various items of PPE must be selected and sized according to the nature of the hazard (particularly electrical) posed by the unit.

	<b>Accident prevention footwear</b>		<b>Protective eyewear</b>
	<b>Protective clothing</b>		<b>Helmet</b>
	<b>Work gloves</b>		

### **GENERAL PRECAUTIONS**

This manual contains detailed instructions for the use, installation and start-up of the UPS. Read the manual carefully before installation. For information on using the UPS, the manual should be kept close at hand and consulted before carrying out any operation on the UPS.

***This UPS has been designed and manufactured in accordance with the standards for the product, for normal use and for all uses that may reasonably be expected. It may under no circumstances be used for any purposes other than those envisaged, or in any other ways than those described in this manual. Any interventions should be carried out in accordance with the criteria and the time-frames described in this manual.***

# Table of Contents

- Safety Warnings ..... vi
- 1. Layout..... 1
  - 1.1. Views ..... 1
  - 1.2 Legends ..... 7
    - Protection Elements:..... 7
    - Power Connections:..... 7
    - Control Connections: ..... 7
    - Keyboard and LCD control panel (PC): ..... 7
    - Other abbreviations: ..... 7
- 2. Installation..... 8
  - 2.1 Important Safety Instructions..... 8
    - 2.1.1 Battery Safety Instructions ..... 9
  - 2.2 Equipment Handling ..... 9
    - 2.2.1 Unpacking and Content Checking ..... 9
    - 2.2.2 Storage ..... 10
    - 2.2.3 Transport ..... 10
    - 2.2.4 Location ..... 10
  - 2.3 Power Connections ..... 11
    - 2.3.1 Preparing UPS..... 11
    - 2.3.2 Connection to Mains Input ..... 12
    - 2.3.3 Connection to the Bypass Input: ..... 12
    - 2.3.4 Connection to the Output ..... 13
    - 2.3.5 External Battery Connection ..... 15
    - 2.3.6 Connection Main Protective Earth..... 15
  - 2.4 Control Connections ..... 16
    - 2.4.1 Com Port to Relay (X32) ..... 16
    - 2.4.3. Local EPO terminals (X50)..... 18
    - 2.4.4 Parallel BUS Connection (X36i) and (X36o)..... 18
    - 2.4.5 External Control Terminals (X18) ..... 19
    - 2.4.6 Alarm Relay Board..... 20
    - 2.4.7 Optional SNMP Communication Card ..... 21
    - 2.4.8 MODBus Communication..... 21
- 3. Operation ..... 22
  - 3.1 Start up ..... 22
    - 3.1.1 Before Start Up ..... 22
    - 3.1.2 Start-Up Procedure Single Module..... 22
    - 3.1.3 Start-Up Procedure Paralleled Modules ..... 23
  - 3.2 Shutdown ..... 27
    - 3.2.1 Inverter Disconnect ..... 27
    - 3.2.2 Complete Shutdown of UPS ..... 27
    - 3.2.3 Emergency Power Off (EPO) ..... 27
  - 3.3 Maintenance Bypass Transfer ..... 28
    - 3.3.1 Transfer to Manual Bypass ..... 28
    - 3.3.2 Transfer to Normal Operation..... 28
    - 3.3.3 Emergency Transfer to Bypass ..... 29
- 4. Control Panel and Display..... 30
  - 4.1 Basic Functions of Keyboard ..... 30
  - 4.2 Screen Description ..... 30
    - 4.2.1 Main Screen..... 31

4.2.2 Control (CNTL) Menu.....	31
4.2.3 Measure (MEAS) Menu.....	32
4.2.4 Setting (SET) Menu .....	34
4.2.3 ALARM .....	35
5. UL924 Emergency Lighting Systems .....	36
6. Maintenance .....	37
6.1 Basic Maintenance Guide.....	37
6.1.1 Periodic maintenance (to be carried out by trained personnel and with doors closed).....	37
6.1.2 Maintenance inside the UPS (factory authorized personnel only).....	37
6.1.3 Ordinary maintenance for batteries (trained personnel only) .....	37
6.2 Internal Battery Replacement .....	38
6.3 Recommended Replacement Intervals .....	39
7. Specifications.....	40
7.1 Technical Specifications .....	40
7.2 Rated Currents and Recommend Field Wiring Information .....	41
7.3 BTU/hr & Weight.....	43
7.4 UL924 Weights.....	45
Appendix A – Alarms .....	47

## Figures

Figure 1 – 10-40kVA Cabinet Front View .....	1
Figure 2 – 10-40kVA Front Cabinet view with inner protective panel removed. ....	2
Figure 3 – 10-40kVA Rear Cabinet view (all units) with inner protective panel removed. ....	3
Figure 4 – 50-60kVA Cabinet Front View .....	4
Figure 5 – 50-60kVA Cabinet Interior Front View .....	5
Figure 6 – 50-60kVA Rear Cabinet view. ....	6
Figure 7 - Recommended spacing around unit.....	11
Figure 8 – Typical Single line diagram of parallel system connection.....	14
Figure 9 – X31 & X32 layout .....	16
Figure 10 – Typical Parallel Communication Connections.....	19
Figure 11 – Alarm Relay Board .....	20
Figure 12 - Settings Screen .....	24
Figure 13 - Advanced Screen.....	24
Figure 14 - Service Screen .....	24
Figure 15 - Parameters Screen page 3 .....	25
Figure 16 - Typical Main screen.....	30
Figure 17 - Typical Control Screen.....	31
Figure 18 - UPS ON/OFF Screens.....	32
Figure 19 - Manual Battery Test Screen.....	32
Figure 20 - Setting Menu.....	34
Figure 21 - Alarm Screen .....	35
Figure 22 - UPS Internal Battery trays.....	38

## Tables

Table 1 - Alarms interface to relays connector DB9 (X32).....	16
Table 2 – External Control Terminals.....	19
Table 3 – Alarm Relay Board .....	20
Table 4 – Battery Models approved for UL924 .....	36
Table 5 – UL924 Approved Systems.....	36
Table 6 - Recommended Replacement Intervals .....	39

1. Layout  
1.1. Views

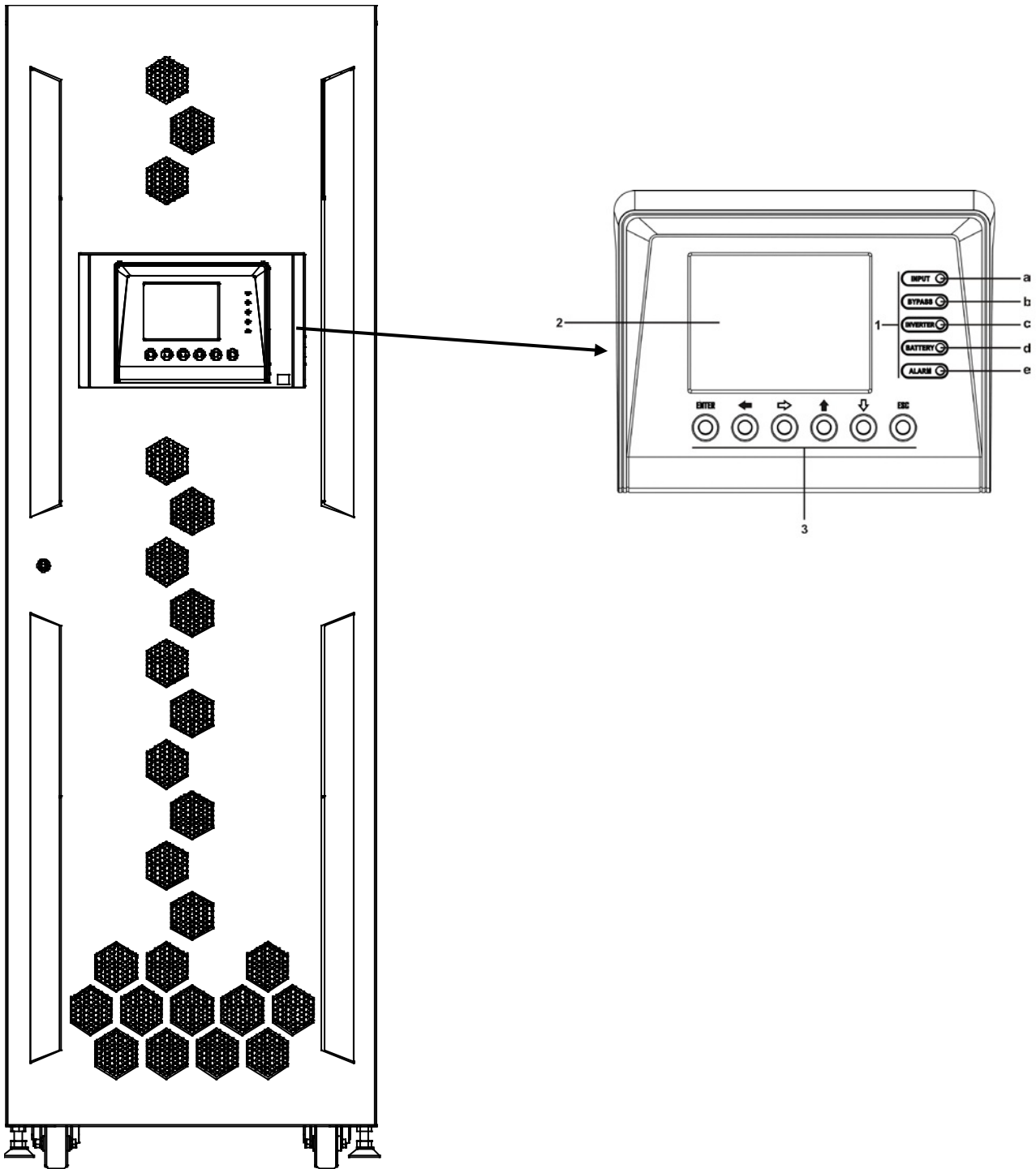
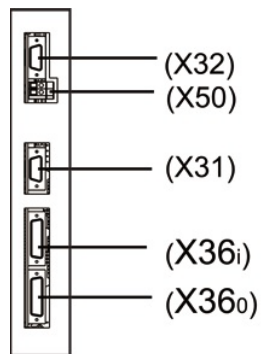
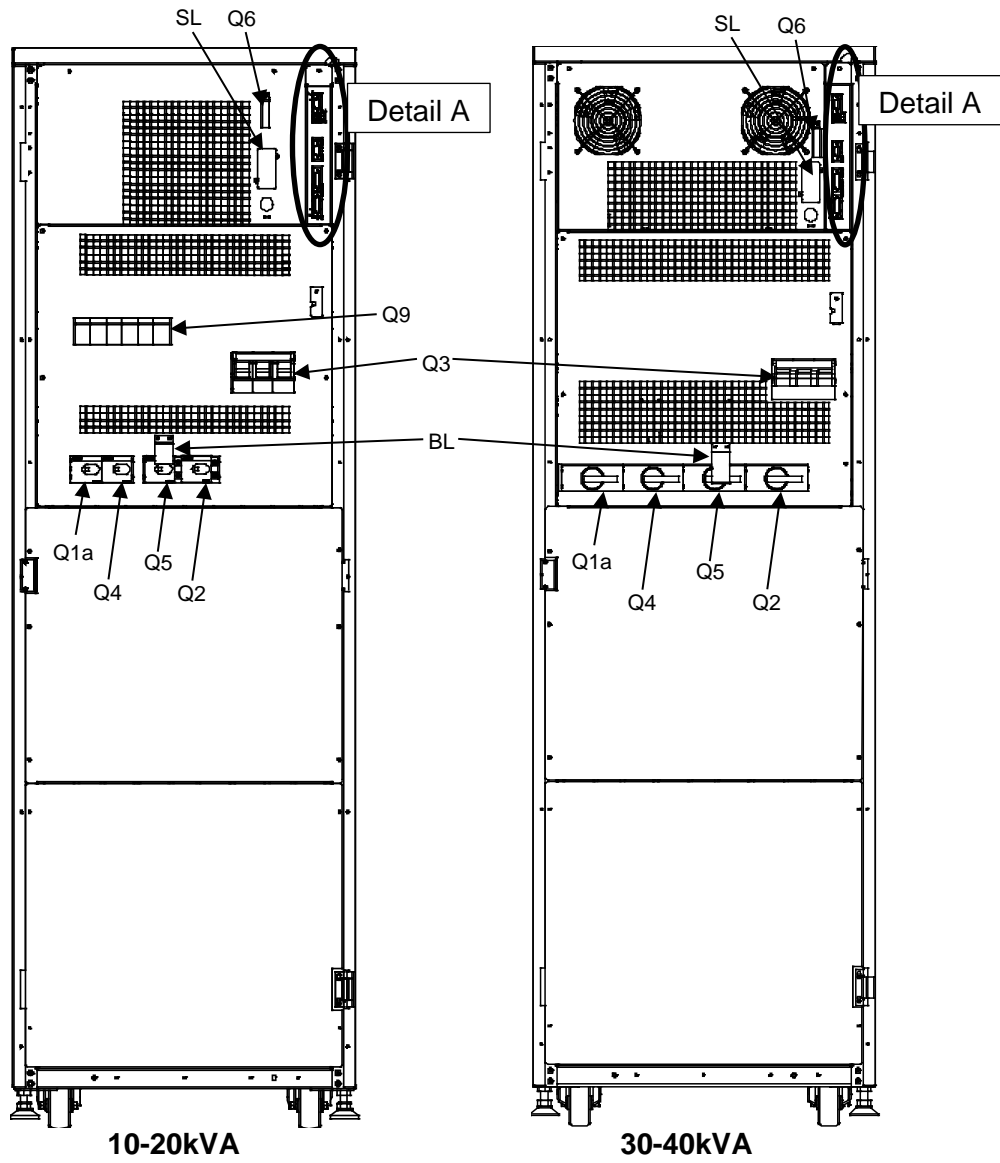

Figure 1 – 10-40kVA Cabinet Front View



Detail A

Figure 2 – 10-40kVA Front Cabinet view with inner protective panel removed.

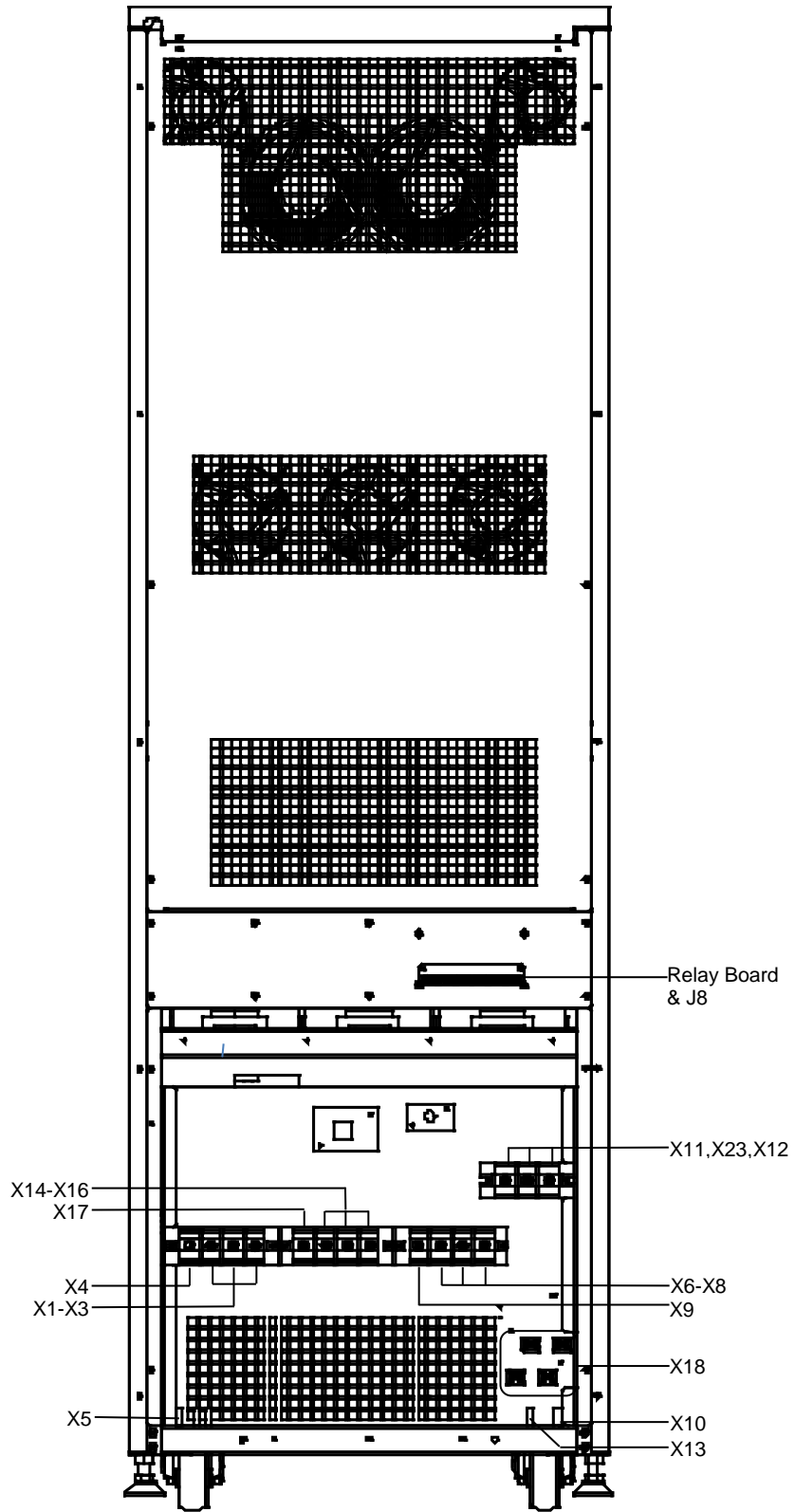
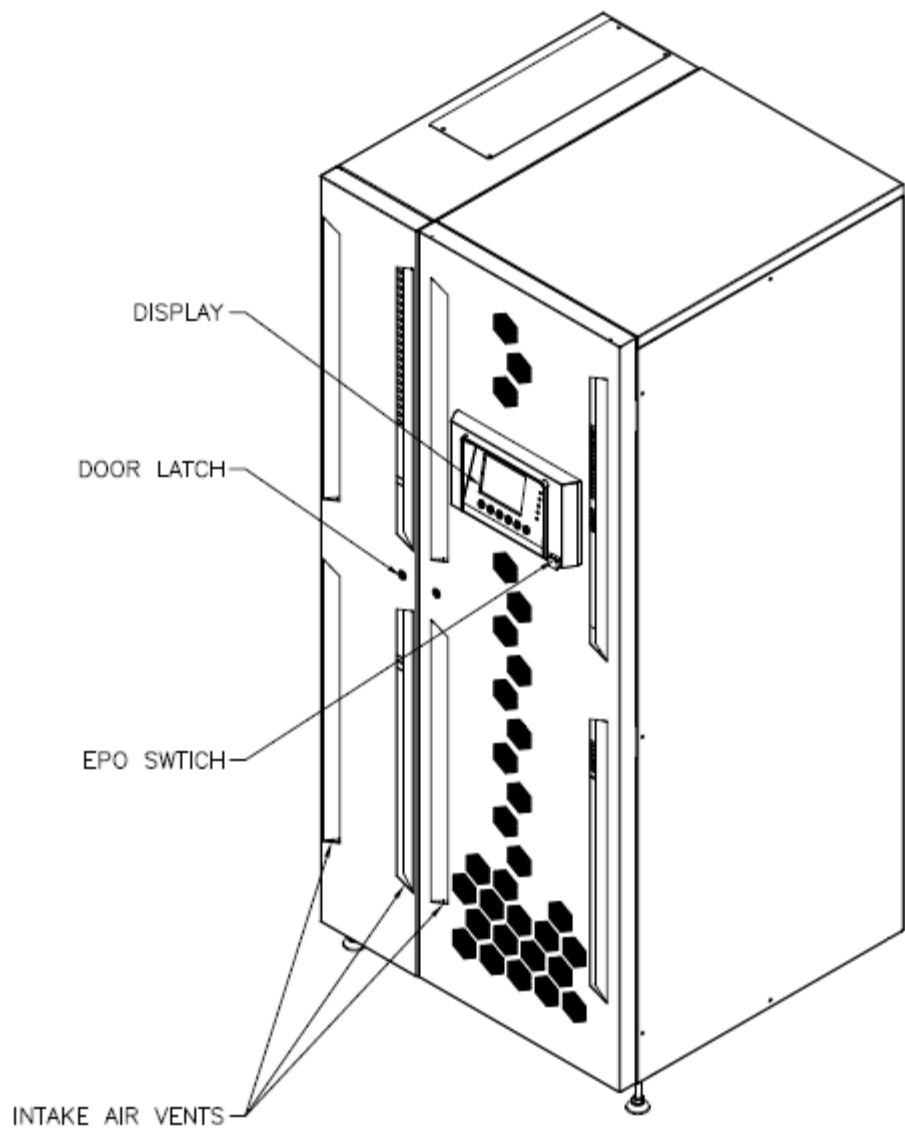

Figure 3 – 10-40kVA Rear Cabinet view (all units) with inner protective panel removed.



UPS CABINET

**Figure 4 – 50-60kVA Cabinet Front View**

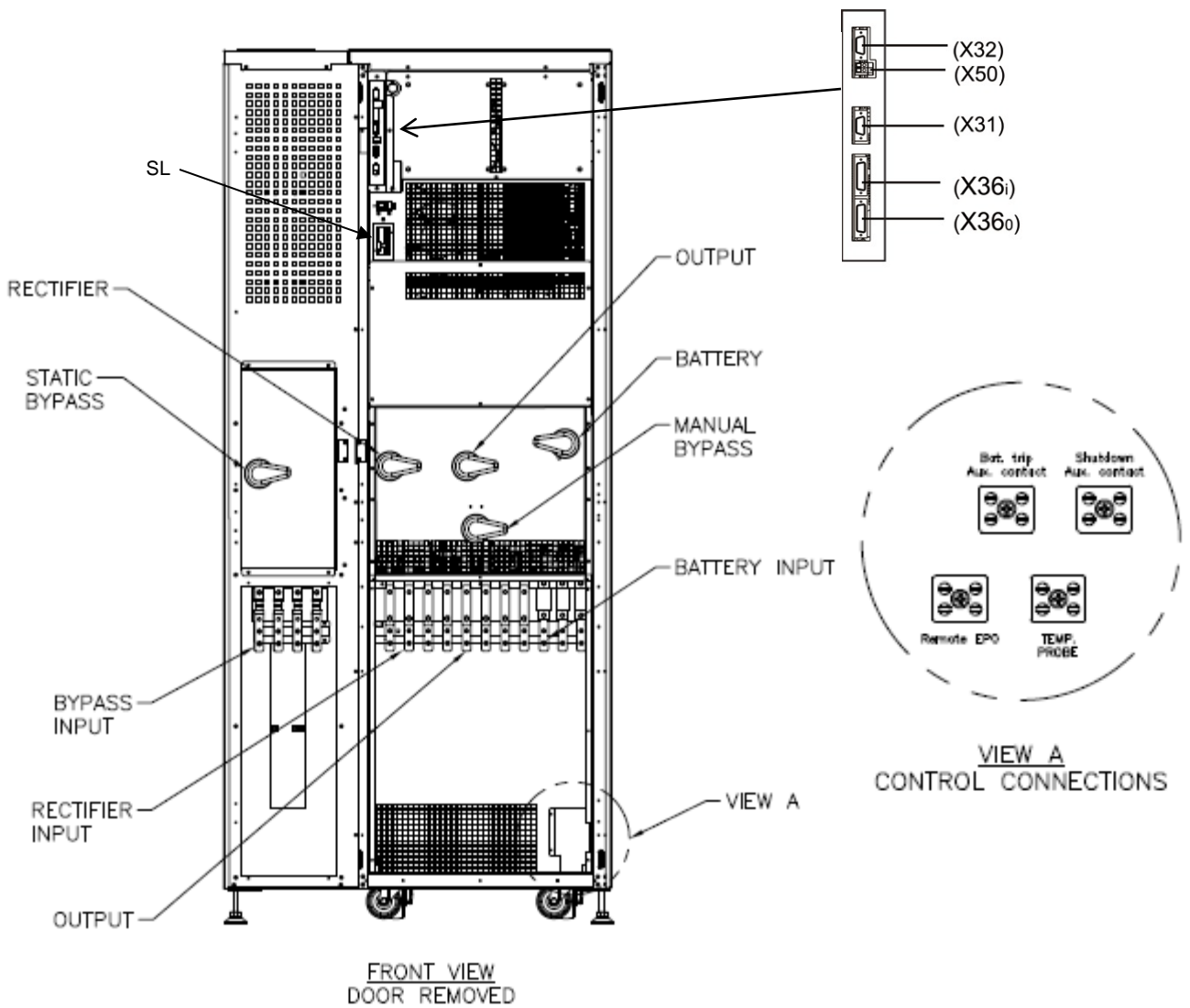
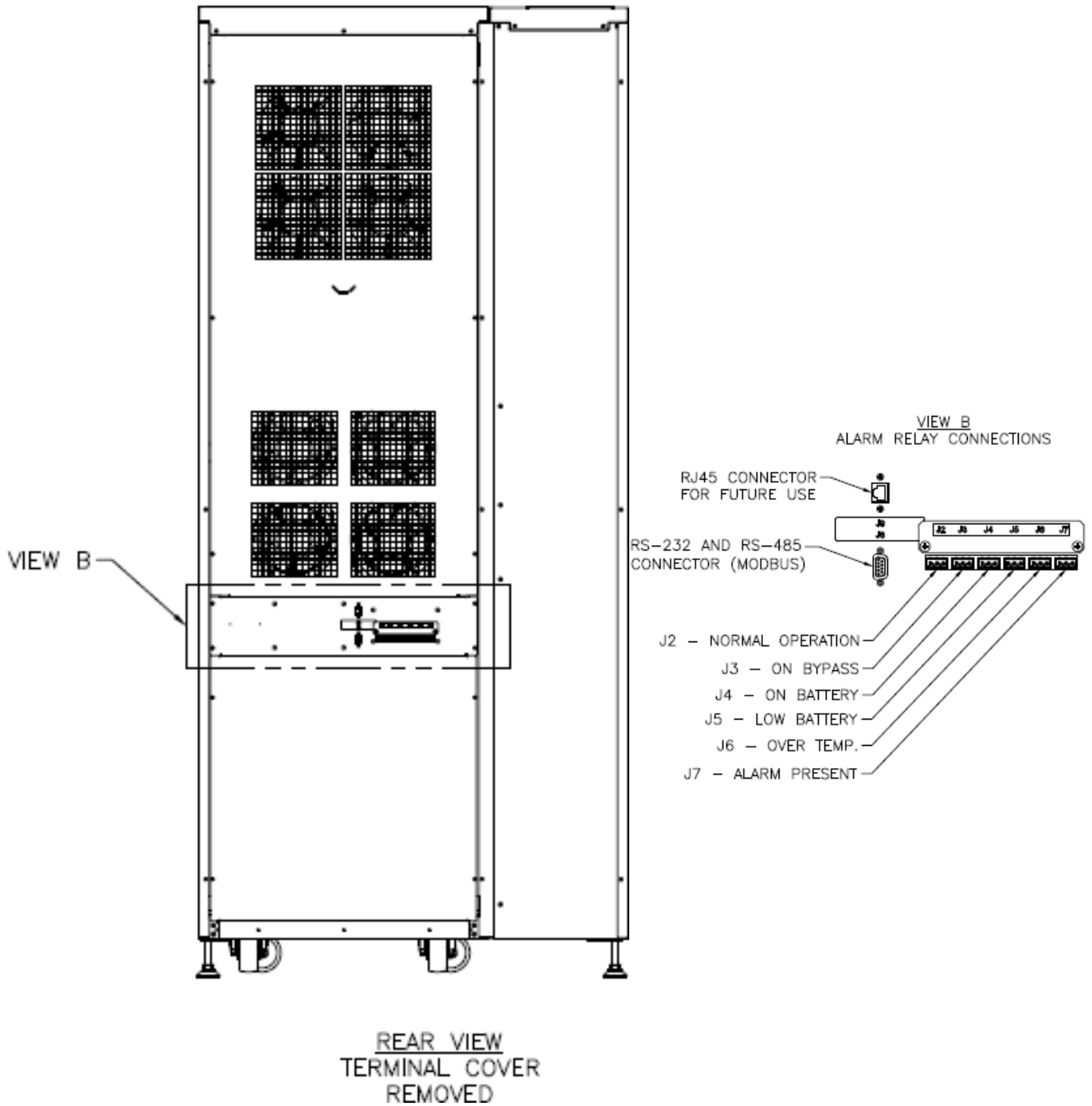

Figure 5 – 50-60kVA Cabinet Interior Front View





**Figure 6 – 50-60kVA Rear Cabinet view.**

## 1.2 Legends

### **Protection Elements:**

- (Q1a) Input Circuit Breaker or Switch.
- (Q2) Output Switch.
- (Q3) Main Battery Disconnect.
- (Q4) Static Bypass Switch.
- (Q5) Manual Bypass Switch.
- (Q6) Emergency Bypass Switch.
- (Q9) Input Fuses.

### **Power Connections:**

- (X1) Phase A input terminal.
- (X2) Phase B input terminal.
- (X3) Phase C input terminal.
- (X4) Input Neutral (N) terminal.
- (X5) Main Earth Ground Terminal.
  
- (X6) Phase A output terminal.
- (X7) Phase B output terminal.
- (X8) Phase C output terminal.
- (X9) Output Neutral (N) terminal.
- (X10) Ground Terminal for loads and battery cabinet(s).
  
- (X11) Positive (+) Battery terminal.
- (X12) Negative (-) Battery terminal.
- (X23) Batteries terminal N.
  
- (X14) Phase A Static Bypass terminal.
- (X15) Phase B Static Bypass terminal
- (X16) Phase C Static Bypass terminal
- (X17) Static Bypass Neutral (N) terminal.

### **Control Connections:**

- (X18) External Control Terminals:
  - Remote EPO,
  - Remote Inverter Shutdown,
  - Remote External Battery Bank Shutdown
  - Battery Temperature detection NTC.
- (X31) Connector to Alarm Relay Board
- (X32) Relay Interface DB9 connector.
- (X36i) Parallel BUS input, Female connector HDB15.
- (X36o) Parallel BUS output, Male connector HDB15.
- (X50) Local EPO.
- (J8) RS-232 and RS-485 COM DB9 connector.

### **Keyboard and LCD control panel (PC):**

- (1) LED Indicators
  - a. Rectifier Input Voltage OK (green).
  - b. Output voltage unit from the Bypass (orange).
  - c. Inverter is working (green).
  - d. Unit working from batteries -mains failure (red).
  - e. General alarm (red).
- (2) LCD Touch Screen.
- (3) Buttons
  - (ENTER)** Enter Key.
  - (ESC)** Escape Key.
  - (↑) Move up.
  - (↓) Move down.
  - (→) Move right.
  - (←) Move left.

### **Other abbreviations:**

- (BL) Mechanical block for manual bypass switch (Q5).
- (SL) SNMP card slot.

## 2. Installation

- Check the Safety Instructions.
- Any incorrect connection or handling may cause damage to the UPS and/or the loads connected to it. Read these instructions carefully and follow the steps indicated.
- This UPS must be installed by qualified electrician.
- It is advisable to provide a maintenance bypass switch or an electrical panel with individual protection for input, output, and static bypass, as well as a manual bypass. This allows isolation of unit during preventive maintenance or repair.

Upon request, a maintenance bypass switch can be sized to your specific requirements.

### 2.1 Important Safety Instructions

#### WARNING



As this is a unit with class I protection against electric shocks, it is essential to install an earth conductor. Connect the ground conductor to the terminal (X5), before connecting the power supply to the UPS input.

Before installing any cables, power or control, verify that all UPS switches are in open position and no power is available to the UPS.

The UPS has multiple electrical inputs and produces electrical output. Verify all terminals are at zero-voltage state before any work on the UPS is performed.

Warning labels should be placed on all primary power switches installed remotely from unit to alert the electrical maintenance personnel of the presence of a UPS in the circuit. The label should bear the following or an equivalent text:

**Before working on this circuit.**  
**- Isolate Uninterruptible Power System (UPS).**  
**- Check for Hazardous Voltage.**  
 **Risk of Voltage Backfeed**

#### WARNING



Once the mains power supply is powered up to the input of the UPS, there may be voltage at the output terminals. To have no voltage on the output terminals, switches (Q1a), (Q4) and (Q2) must be in Off position.

The output terminals may have output voltage from the manual bypass. If the output power supply of the UPS has to be interrupted, open switch (Q5).

Precautions must be taken working around the batteries. Batteries are not isolated from the AC input, and dangerous voltage between the battery terminals and the ground may be present.

### 2.1.1 Battery Safety Instructions

#### **WARNING**



The handling and connection of the batteries shall be done and supervised by personnel with battery knowledge.

If an installed a -0 version UPS (no internal battery) and want to install batteries, consult with factory service before attempting to install batteries.

**Only a qualified technician should attempt to install or replace batteries in this equipment.** See **6.2 Internal Battery Replacement** in this manual for detailed instructions.

The battery supply can involve the risk of electric shock and can produce high short circuit current. Observe the following preventive measures before working with Battery Terminals:

- Disconnect the corresponding protection elements.
- When connecting a battery cabinet to the UPS, verify correct polarity.
- Wear rubber gloves and shoes.
- Use tools with insulated handles.
- Removes watches, rings or other metal objects.
- Do not place metal tools or objects on the batteries.
- Never short the battery terminals as it will result in a high safety risk and potential damage to the battery and the UPS.
- Avoid mechanical impacts.
- Do not open or mutilate the battery. Released electrolyte is harmful to the skin and eyes.
- Do not dispose of batteries in a fire. The batteries may explode.
- In case of contact of the acid with parts of the body, wash immediately with plenty water and seek medical help.
- Batteries involve a serious risk for health and for the environment. Their disposal should be done according to the existing laws.

## **2.2 Equipment Handling**

### **2.2.1 Unpacking and Content Checking**

Upon receiving the UPS, make sure that it has not suffered any damage in transport. If any shipping damage is noticed, make all pertinent claims to the carrier. Also check that the data in the nameplate, which is attached inside the front door, corresponds to those specified in the purchase order; it will be necessary to unpack it. To unpack, cut the bands on the cardboard container and remove it by lifting above or remove it with the necessary tools if made of wood; remove the corner pieces and the plastic sleeve. The UPS should be unpacked on the pallet.

When the unit has been accepted, it is best to repack the UPS until it is put into service in order to protect it from any possible mechanical damage, dust, dirt, etc....

### **2.2.2 Storage**

Storage of the UPS should be in a dry, ventilated place and protected against rain, water or chemical agents. It is advisable to maintain the UPS in the original package which has been designed to assure the maximum protection during transport and storage.



The UPS may have installed batteries and should not be stored for more than 12 months at 25 degrees C or 3 months at 40 degrees C. Extended storage at elevated temperatures will cause irreversible damage to the battery.

When a long storage time is required, the batteries can be maintained:

- 1 Unpack UPS
- 2 Connect the UPS to an Input Utility.
- 3 Startup UPS according to the instructions described in this manual and charge the batteries for 24 hours.
- 4 Then shut down the UPS, disconnect it and keep the UPS in their original packaging until the next charge is required.



Do not store the unit where the ambient temperature exceeds 40° C or falls below -20° C, as this may degrade the electrical characteristics of the batteries.

### **2.2.3 Transport**

All UPS have castors to facilitate transport to their final location. It is important to observe the rough weights indicated in the technical specs both with respect to the site itself and the means to be used to put it there (floor, hoist, lift, stairs, etc...).

### **2.2.4 Location**



The UPS requires a minimum of 8 inches clearance in the back. Clearance above the UPS must be 18 inches minimum. Failure to adhere these minimum clearances will result in overheating.

Adequate space must be provided in front for service and maintenance (See **Figure 7**). In parallel systems or systems with external battery or other cabinets there is no requirement to separate the cabinets other than maintaining the ability to service the UPS and assuring the paralleling cables can connect to each unit. Using flexible conduit for power wiring may provide some benefit.

Two levelers located close to the front casters are used to level and straighten the UPS once it is placed. Open the front door of the cabinet and loosen the leveling by turning them counter clockwise until they touch the floor, and then using a tool, continue turning until the castors are raised off the floor by a maximum 0.2 in, ensuring that UPS is level. Close the door.

Access to side will be required only for maintenance/repair of the UPS.

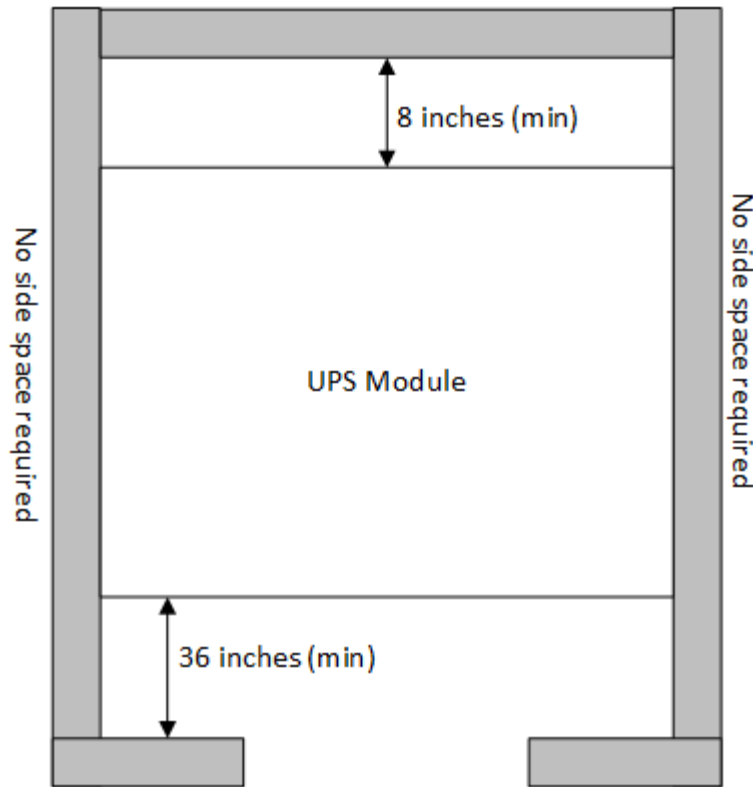

**Figure 7 - Recommended spacing around unit**

## 2.3 Power Connections

### 2.3.1 Preparing UPS

All of the UPS models have terminals for power connection and DB9 connectors for communications located inside the UPS front door. Follow the steps described below for access to all connections:

- Unlock the front door lock with the provided key.
- DB9 connectors for communication ports are located at the top right side of the inner panel.
- Terminals for remote EPO and other functions are located at the bottom front.
- Remove the screws securing the terminal cover inside of the cabinet and set it aside. The input, output and external battery terminals are now exposed.
- Once the connection of the UPS is finished, replace the cover and close the door.



Wire size should be in accordance with NEC and local code using the currents shown in **7.2 Rated Currents and Recommend Field Wiring Information**



In parallel systems, the length and cable cross section from the distribution panel to each UPS and from each UPS to the load panel will be the same for all without any exception. This is required to maintain load balance between parallel units.

Circuit protection in power distribution panels should have following characteristics:

- For input and bypass, type B earth leakage breakers and circuit breakers curve C.
- For the output, circuit breaker curve C.
- Their size will be compatible, as minimum, with the currents stated in **7.2 Rated Currents and Recommend Field Wiring Information**
- 

If input, output or bypass peripherals were added to the UPS, like transformers or autotransformers, follow the installation instructions in the manuals for those units.

The UPS is equipped with fuses located between the external battery connection (X11, X12, X23) and the internal battery. These fuses are located in a disconnect Q7 (10Kva ~ 20Kva) or 2 larger panel mount fuses located below Q3 (30/40Kva). 50/60kVA units have fuses located at the Battery Terminals.



10-40kVA models have 3 fuses located in a fuse holder/disconnect Q3. These fuses isolate the battery from the inverter and must be installed into Q3 and closed before the UPS will be fully operational.

## Danger



**It is critical that the disconnect Q3 is not closed with the fuses installed until instructed to do so by the front panel LCD during the start-up sequence. Failure to comply may result in damage to the UPS.**

### **2.3.2 Connection to Mains Input**



#### **Connection to the ground:**

This unit is class I protection against electric shocks, a ground conductor must be installed. Connect the conductor from to the terminal (X5), before connecting the power to the UPS input. See **7.2 Rated Currents and Recommend Field Wiring Information** for current ratings.

#### **Connection to the Input:**

Connect the power supply cables N-A-B-C to the input terminals (X4), (X1), (X2) and (X3), following the order of neutral and phases indicated on the label of the unit and in this manual.

See **7.2 Rated Currents and Recommend Field Wiring Information** for current ratings.



If the order of the phases is not followed, the unit will not operate. When there are discrepancies between the labeling and the instructions of this manual, the label on the UPS will always prevail.

### **2.3.3 Connection to the Bypass Input:**

#### **Independent Bypass Input**

For UPS configurations where the bypass input is separate from the rectifier input.



#### **Connection to the ground:**

This unit is class I protection against electric shocks, a ground conductor must be installed. Connect the conductor from to the terminal (X5), before connecting the power to the UPS input. See **7.2 Rated Currents and Recommend Field Wiring Information** for current ratings.

### Connection to the Bypass:

Some UPS configurations have jumper wires between terminal X1-X4 and X14~X17. For Independent bypass configuration, these jumpers need to be removed.

Connect the bypass power supply cables N-A-B-C to the static bypass line terminals (X17), (X14), (X15) and (X16), following the order of neutral and phases indicated on the label of the unit and in this manual.



If the order of the phases is not followed, the unit will not operate. When there are discrepancies between the labeling and the instructions of this manual, the label on the UPS will always prevail.

## WARNING



Whenever a single UPS is fed with dual inputs or there are parallel connected UPSes, particular care needs to be taken with regards to the Neutral wiring. It is prohibited to create a configuration that might lead to current flowing through ground conductors except during the occurrence of an insulation fault. For a dual input configuration, this means that both the bypass input and the rectifier input must be fed from sources that have a common Neutral to Ground Bond. Typically, this means that they must be fed from the same panel. If they need to be fed from distinct sources, then the UPS installation must include an isolation transformer for each input and those transformers must share a common ground bonding point for their neutrals.

In a system that consists of parallel UPSes, ALL inputs must be fed from sources that share a common bonding point for the neutrals. If it is necessary to feed the system from sources that are not common, then an isolation transformer must be used at each input and the transformers must share a common neutral to ground bond. Contact Staco Representative if assistance is required.

When UPS is connected to independent bypass source the setting for bypass type needs to change to: **Independent** in advance Parameter menu. See **4.2 Screen Description** for Parameter menu access.

### 2.3.4 Connection to the Output



#### **Connection to the ground:**

This unit is class I protection against electric shocks, a ground conductor must be installed. Connect the conductor from to the terminal (X5), before connecting the power to the UPS input. See **7.2 Rated Currents and Recommend Field Wiring Information** for current ratings.

### **Single Module**

Connect the loads cables N-A-B-C to the output terminals (X9), (X6), (X7) and (X8), following the order of neutral and phases indicated on the label of the unit and in this manual.



If the order of the phases is not followed, the unit will not operate. When there are discrepancies between the labeling and the instructions of this manual, the label on the UPS will always prevail. A user accessible disconnect device sized appropriately to **7.2 Rated Currents and Recommend Field Wiring Information** shall be installed from output of UPS to critical load.



## Paralleled Modules

From each module in system, connect the loads cables N-A-B-C to the output terminals (X9), (X6), (X7) and (X8), following the order of neutral and phases indicated on the label of the unit and in this manual.



If the order of the phases is not followed, the unit will not operate. When there are discrepancies between the labeling and the instructions of this manual, the label on the UPS will always prevail.

With respect to the protection that must be placed on the output of the UPS, it is recommended that the output power should be distributed in at least four lines. Each will have a user accessible magnetic thermal protection switch of a value of one quarter of the nominal power. This type of power distribution will mean that in the event of a fault, the fault will be isolated. The rest of the connected loads will have their continuity assured due to the triggering of the protection, only the line affected by the fault will remain. See **Figure 8** for diagram.

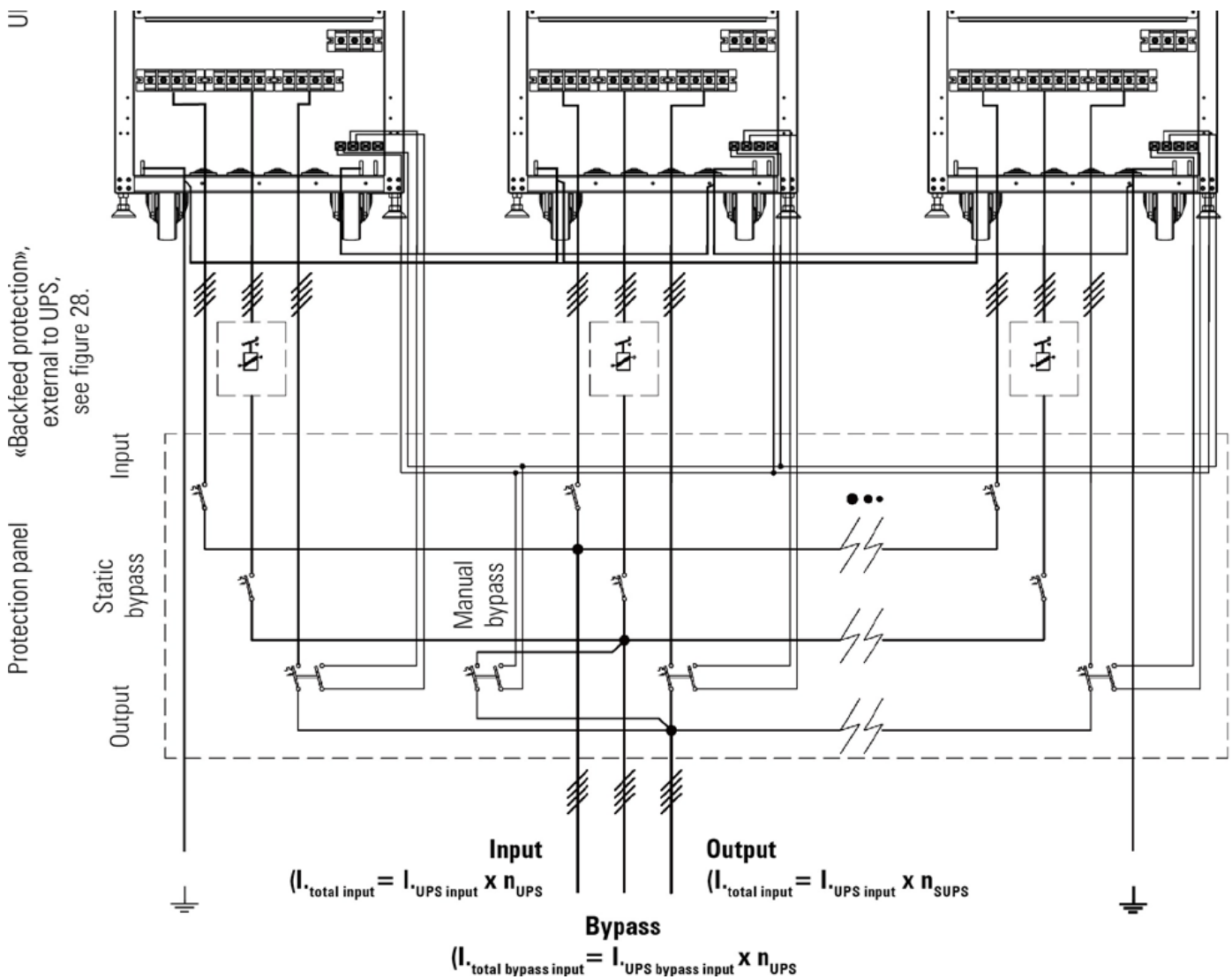

**Figure 8 – Typical Single line diagram of parallel system connection**

### 2.3.5 External Battery Connection

#### Danger



**On units with internal batteries, there will be a high level DC voltage across these terminal connections.** Use extreme caution when connecting the external batteries. Only use properly insulated tools. Failure to comply may cause irreversible damage to the UPS or personal harm.



**Connection to the ground:**

This unit is class I protection against electric shocks, a ground conductor must be installed. Connect the conductor from to the terminal (X5), before connecting the power to the UPS input.

#### Danger



**IMPORTANT FOR SAFETY:** Do not close the battery fuse holder (Q3) located in the UPS until instructed to do so in the startup procedure. Failure to comply may cause irreversible damage to the UPS or personal harm because the operator is exposed to ELECTRICAL DISCHARGE DANGERS when connecting the UPS battery.

UPS connection with an external battery will be made by connecting properly sized cables to terminals (X11), (X23) and (X12), matching polarity at the external battery terminals.



Insure that the external battery complies with the battery requirements for this UPS system. See the external battery documentation for connection details.

If more than one external battery cabinet is to be connected, the connection will always be in parallel among them and the UPS's cable from the negative of the UPS to the negative of the first battery pack and from this one to the negative of the second battery pack, and so on. Proceed in the same way for positive cables, half tap (N) and earth.



When connecting external battery cabinets to multiple UPS in a parallel configuration, each UPS must have its own separate battery cabinet(s). A single battery cabinet cannot be shared between multiple UPS.

#### Danger



If after starting up the UPS, it is required to disconnect the battery cabinet, the UPS has to be completely shut down (see shut down section). Turn off the battery cabinet circuit breaker and/or fuse holder disconnect (**Q3**) located in the UPS. Wait at least 5 min. until the filter capacitors have been discharged.

### 2.3.6 Connection Main Protective Earth

Make sure that all loads connected to the UPS are only connected to the ground bonding terminal. Grounding of the load(s) and/or the battery case(s) or cabinet(s) to this single point will help prevent ground loops which will affect the quality of the power supplied.

All of the terminals identified as ground, are joined together, to the main grounding terminal and to the frame of the unit.

## 2.4 Control Connections

### 2.4.1 Com Port to Relay (X32)



The communications line (COM) constitutes a very low safety voltage circuit. To preserve the quality, it must be installed separately from other lines that have dangerous voltages (power distribution line).

The communication port to relays provides digital signals in the form of potential free form A contacts. X32 (see **2.4.2.2 RS-485**) connections can be used for connecting the UPS with any machine or units that has standard bus (connector DB9 (X32)). See **Figure 2** or **Error! Reference source not found.**

Standard units consist of 3 output signaling relays (one of which is configurable), with common point is connected to pin 5. Also an input signal can be externally supplied to perform Shutdown (5V~12V).

Pin-out No.	Description	N.C. - N.O. Position	Voltage/ Current
1	Shutdown signal +	-	6 A, 30 V DC or 6 A, 100 V AC
2	Shutdown signal –	-	
3	Reserved		
4	Reserved		
5	Common	-	
6	Equipment in Bypass	N.O.	
7	Low battery	N.O.	
8	General alarm	N.O.	
9	Reserved		

N.C.: Normally closed contact. When alarm is activated the contact is opened.

N.O.: Normally open contact. When alarm is activated the contact is closed.

**Table 1 - Alarms interface to relays connector DB9 (X32).**

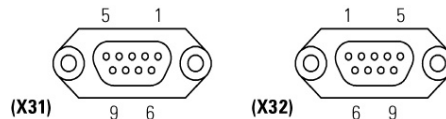

**Figure 9 – X31 & X32 layout**

## 2.4.2 COM port RS-232 & RS-485. Connector (J8).



The communications line (COM) constitutes a very low safety voltage circuit. To preserve the quality, it must be installed separately from other lines that have dangerous voltages (power distribution line).

In the connector DB9 there are ports of communication of the UPS to the RS-232 and the RS-485. It is not possible to use them simultaneously as both are mutually exclusive. Connector J8 can be used for connecting the UPS with any machine or units that has standard bus. See **Figure 3** or Error! Reference source not found..

### 2.4.2.1 RS-232

#### Physical structure of the RS-232

Pin-out

- Pin 2. RXD. Serial data reception.
- Pin 3. TXD. Serial data transmission.
- Pin 5. GND. Signal mass.

#### Communication protocol of the RS-232

The communication protocol used is of «MASTER/SLAVE» type. The computer or computer system («MASTER») asks about a certain data, and the UPS («SLAVE») answers immediately with the required data. First the communication channel of the computer will be programmed with the same parameters as the communication channel of the UPS.

- Communication speed: 1200, 2400, 4800, 9600 or 19200 Bauds.
- No. information bits: 8 Bits.
- No. stop bits: 1 or 2 stop bits.
- Parity: - Even, Odd or None.

### 2.4.2.2 RS-485

#### Physical structure of the RS-485

The unit uses only 2 wires (pins 4 and 9 of the female DB9 connector) to perform the dialogue between the systems connected to the network. The communication will be established by sending and receiving signals in a differential mode, which gives the system great immunity to noise over a long distance (approx. 800 m).

Pin-out

- Pin 4. Output signal A (+) of the RS-485.
- Pin 9. Output signal B (-) of the RS-485.

#### Communication protocol of the RS-485

The communication protocol of the RS-485 channel is developed to enable the UPS to communicate with other computer systems that utilize the same protocol.

- Communication speed: 1200, 2400, 4800, 9600 or 19200 Bauds.
- No. information bits: 8 Bits.
- No. stop bits: 1 or 2 stop bits.
- Parity: - Even, Odd or None.

### **2.4.3. Local EPO terminals (X50)**

A local EPO button is mounted on the front panel next to the LCD. After an EPO event using this button it must be depressed again to clear the EPO before the UPS can be restarted.

The EPO switch must be normally closed and latch open when pressed in order to open the circuit (X50) to activate the emergency shutdown. To restore the UPS to normal mode, return the position of the switch or button (EPO), close the circuit (X50).

For operating instructions for the (EPO), see **3.2.3 Emergency Power Off (EPO)** of this manual.



In a parallel system only one remote EPO is required to control all of the units in the system.

### **2.4.4 Parallel BUS Connection (X36i) and (X36o)**



This section is only used for parallel systems. Up to four UPS of the same model can be paralleled.

In order to allow correct operation of all functions, each UPS in a parallel system will communicate with the others through a set of cables forming a communications loop. Once the power connections of the UPS from parallel systems are made, it is required that the parallel communication cables (supplied) be connected. Each UPS is supplied with a pair of 5 meter cables with HDB15 connectors at their ends, one male and the other one female.

## **Warning**



**ANY MODIFICATION TO THE COMMUNICATION BUS CABLES OR CONNECTORS WILL RESULT IN UPS FAILURE.**

Begin with the first unit and connect one end of the supplied communications cable to the appropriate mating connector (X36o) on the UPS. Connect the other end of that same cable to (X36i) on the next UPS. Continue in this manner by finishing with the final cable connection from the last UPS in the system back to the first. A communications loop has now been formed between all of the units in the system. **See Figure 10.**

The bottom of front door has a cutout to allow passage of the cables in case the installer does not want to run them through conduit. Take care to not trap cables between the door ends and the cabinet when closing.

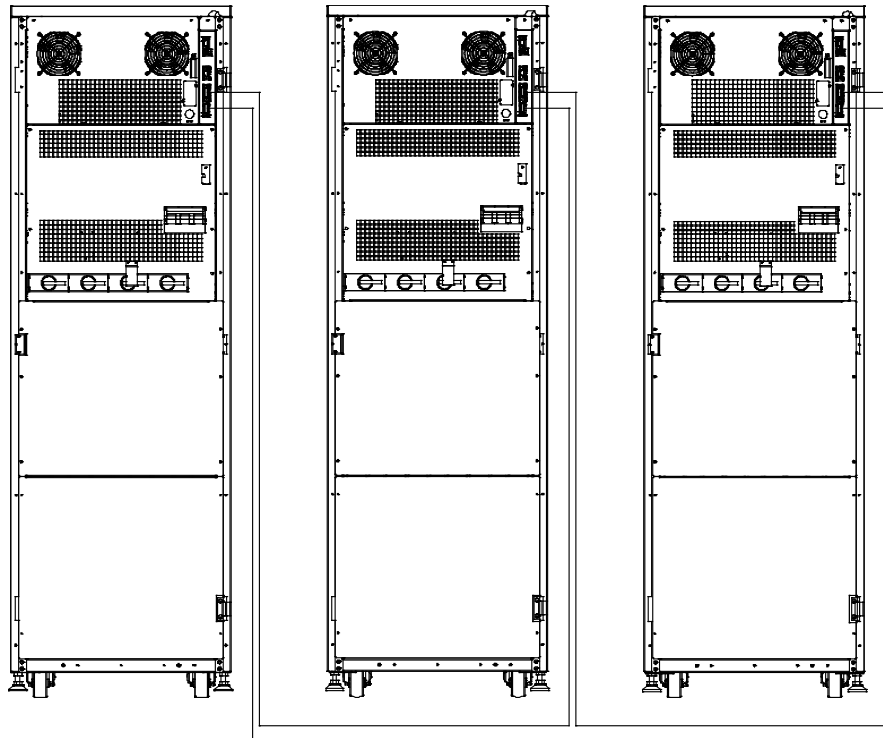

**Figure 10 – Typical Parallel Communication Connections**

**2.4.5 External Control Terminals (X18)**

Remove the screws from the protective panel covering the terminals (see **Figure 3** or **Figure 6**). Set the panel aside and feed the wires through from the bottom. After connecting, replace protective panel.

<u>Terminal</u>	<u>Voltage</u>	<u>Current</u>	<u>Wire Range</u>	<u>Torque</u>
Remote EPO	30 V DC 100 V AC	6A	6mm <sup>2</sup> (max)	2.5-3.5 in-lbs (0.3-0.4 N-m)
Remote Inverter Shutdown				
Remote External Battery Bank Shutdown*				
Battery Temperature Detection NTC				

Contacts are Normally Closed contacts (when the contacts are open, the contacts will be activated).

\*Contact will activate when the UPS has been EPO.

**Table 2 – External Control Terminals**

**2.4.6 Alarm Relay Board**

The Alarm Board is active (powered up) when the UPS output is ON. It relays based upon the status of UPS. There are six connections, J2 through J7.

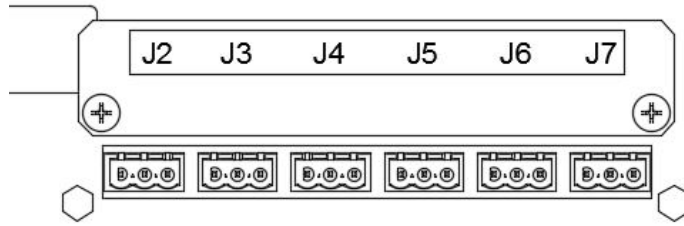

**Figure 11 – Alarm Relay Board**

Connection	Description	Terminal	Type	Rating	Wire Size	Torque
J1	Internal connection					
J2	Normal Operation	1	N. C.	30 V (AC or DC); <2 A	#22-#12 AWG	4.4 in-lbs.
		2	Com			
		3	N.O.			
J3	On Bypass	1	N. C.			
		2	Com			
		3	N.O.			
J4	On Battery	1	N. C.			
		2	Com			
		3	N.O.			
J5	Low Battery	1	N. C.			
		2	Com			
		3	N.O.			
J6	Over Temperature	1	N. C.			
		2	Com			
		3	N.O.			
J7	Alarm Present	1	N. C.			
		2	Com			
		3	N.O.			

N.C. – Normally Closed – shorted to Com when signal is not energized

N.O. – Normally Open – shorted to Com when signal is activated

**Table 3 – Alarm Relay Board**

### 2.4.7 Optional SNMP Communication Card

If the SNMP Card is installed, the following settings need to be made for the card to communicate properly.

#### UPS Port 2 Setting: (see Section 4.2.4.1 Basic Settings)

Baud Rate: 9600  
Parity: None  
Stop Bits: 1  
Protocol: SEC

#### SNMP Card Setting:

UPS Communication Type: SEC 9600 Three Phase

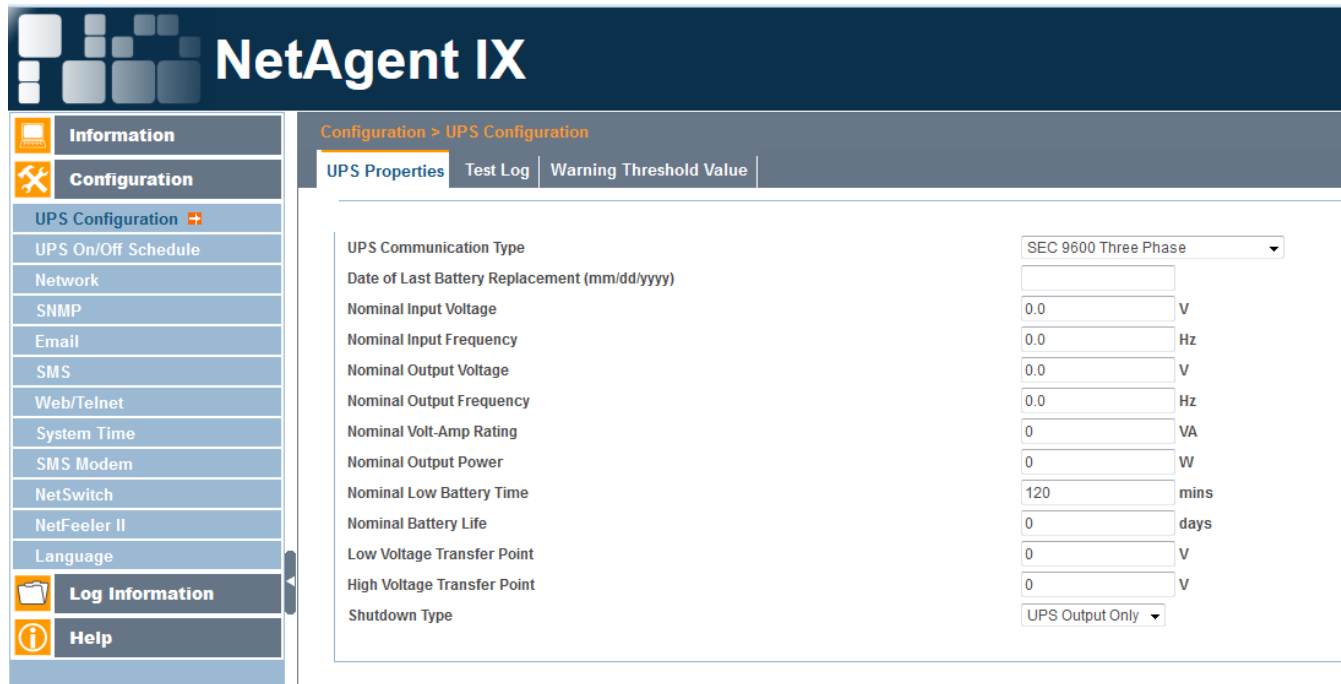

### 2.4.8 MODBus Communication

When MODBus Communication is used, the following settings need to be verified for the card to communicate properly. MODBus communication is at J8 Connection.

#### UPS Port 0 Setting: (see Section 4.2.4.1 Basic Settings)

Baud Rate: 9600  
Parity: None  
Stop Bits: 1  
Protocol: Modbus  
See Staco website (<http://www.stacoenergy.com/>) for latest protocols.

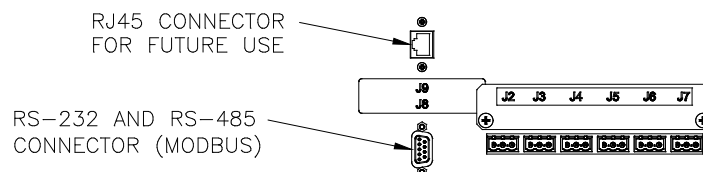



### 3. Operation



It is critical that the following procedure be followed in the sequence given.

#### 3.1 Start up

##### 3.1.1 Before Start Up

Verify that all the connections have been made correctly and are sufficiently tight, following the labeling of the phase rotation sequence.

Check that the UPS switches and any external battery cabinet or cabinets are in off position.

Be sure that all the loads are turned off.

##### 3.1.2 Start-Up Procedure Single Module



It is very important to follow the established order during the following instructions. **DO NOT** close Q2 until instructed to do so.

1. If the UPS is connected to an external battery cabinet(s), close battery cabinet breaker(s).
2. Close the mains circuit breaker to provide power to the input of the UPS.
3. Turn the input switch (Q1a) to “On” position. The display of the Control Panel will be turned on automatically. **DO NOT** close any other switches at this time.

If the following alarm message appears on the Control Panel Display, the UPS cannot be started because of incorrect input phase sequence.

**! MAINS PHASE ROT. UPS START INH.**

Disconnect the input switch (Q1a) and the mains power. Swap the phases of the input terminals of the UPS according to the labeling and repeat the start-up process.

4. Turn the Bypass switch (Q4) to “On” position.

Units with separate Bypass, if the following alarm message appears on the Control Panel Display, the UPS cannot be started because of incorrect input phase sequence.

**! MAINS PHASE ROT. UPS START INH.**

Disconnect the Bypass switch (Q4) and the mains power. Swap the phases of the input bypass terminals of the UPS according to the labeling and repeat the start-up process.

5. At this point, with no alarm active, green LED indications of Input Voltage OK, and orange LED indication of Unit on Bypass should light ((a), (b) from **Figure 1** or **Figure 5**).



The startup operation will be done through the keypad of the control panel ((3) from **Figure 1** or **Figure 5**).

6. Start up the inverter through the keypad of the control panel.
  - a. Select “CNTL”,
  - b. Select “ON”.
  - c. Screen to start the unit up will appear, select 



Pressing



will cancel start-up

7. After 30 seconds, the inverter and rectifier will start.
8. Turn the output switch (Q2) to “On” position.
9. The system will supply voltage at the output terminals.
10. Make sure that the inverter LED (c) is turned on (green), and bypass LED (b) is turned off in all UPS’s (see **Figure 1** or **Figure 5**). If the led status is not the correct, contact Service and Technical Support.
11. Once the rectifier is completely started, the process of equalization (DC bus voltage starts to equalize with battery voltage) is started. After a few seconds (depending on the battery level), an alarm message will display that the equalizing process has been finished, and **AT THIS MOMENT ONLY** is when the battery fuse holder disconnect on the UPS (**Q3**) can be closed.

**! BATT. SWITCH OPEN, SWITCH IT ON**



**DO NOT TRY to close Q3 battery fuse disconnect at any other time or there may be damage to the UPS.**

12. The system is now started up completely, and the UPS is protecting the critical load.

### **3.1.3 Start-Up Procedure Paralleled Modules**



It is very important to operate in the established order during the following instructions. The instructions assume that each unit in the system has all internal jumpers set correctly by factory authorized personnel.

1. If any UPS is connected to an external battery cabinet(s), close battery cabinet breaker(s).
2. Close the mains circuit breaker to provide power to the input of the each UPS in the system.
3. Turn the input switch (Q1a) to “On” position for each UPS in system. Each display of the Control Panel will be turned on automatically. Do not close any other switches at this time.

If the following alarm message appears on the Control Panel Display and also an audible alarm comes on, the UPS cannot be started because of incorrect input phase sequence.

**! MAINS PHASE ROT. UPS START INH.**

Disconnect the input switch (Q1a) and the mains power. Swap the phases of the input terminals of the UPS according to the labeling and repeat the start-up process.

4. Configure each UPS in System
- Enter into the Settings screen as shown in **Figure 12**.

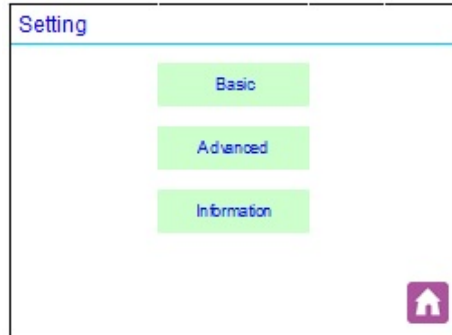

**Figure 12 - Settings Screen**

- Go into the Advanced screen as shown in **Figure 13**. The password is 01899. (For more information on the Advanced Settings screen, see **4.2 Screen Description**).



**Figure 13 - Advanced Screen**

- The Service screen will now be visible, see **Figure 14**. From this screen, touch the Parameters button.



**Figure 14 - Service Screen**

- d. In the Parameters section, go down to page 3. (See **Figure 15**)
  - i. All UPS's should have a default address of 1 to start. Verify the first unit is set to 1, then go to each of the remaining units and set the address to 2, 3, or 4 depending on how many units are in the group.
  - ii. Set Parallel Unit to "Yes".
  - iii. Set Parallel Total Number to the number of UPS units in system (maximum of 4).

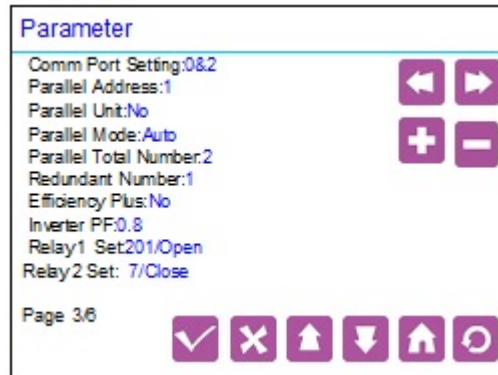

**Figure 15 - Parameters Screen page 3**

5. Turn the Bypass switch (Q4) to "On" position for each UPS in the system.

Units with separate Bypass, if the following alarm message appears on the Control Panel Display and also an audible alarm comes on, the UPS cannot be started, because of incorrect input phase sequence.

**! MAINS PHASE ROT. UPS START INH.**

Disconnect the Bypass switch (Q4) and the mains power. Swap the phases of the input bypass terminals of the UPS according to the labeling and repeat the start-up process.

6. At this point, with no alarm active, green LED indications of Input Voltage OK, and orange LED indication of Units on Bypass should light ((a), (b) from **Figure 1** or **Figure 5**).



The startup operation will be done through the keypad of the control panel ((3) from **Figure 1** or **Figure 5**).

7. Turn the output switch (Q2) of each UPS in system to "On" position.
8. Start up the inverter through the keypad of the control panel.
  - a. Select "CNTL",
  - b. Select "ON" and.
  - c. Screen to start the unit up will appear, select. 



Pressing  will cancel start-up

9. After 30 seconds, the inverter and rectifier will start.



The first UPS inverter to start will be set as “Paral. Mst. Byp” initially, the one with the highest address as “Paral. Slv. By.Rsv” and the rest, if there are any as “Paral. Slv. By”. In systems with just two UPS the “Paral. Slv. By” will not exist.

10. The system will supply voltage at the output terminals.

11. Make sure that the inverter LED (c) is turned on (green), and bypass LED (b) is turned off in all UPS’s (see **Figure 1** or **Figure 5**). If the led status is not the correct, contact Service and Technical Support.

12. Once the rectifier is completely started, the process of equalization (DC bus voltage starts to equalize with battery voltage) is started. After a few seconds (depending on the battery level), an alarm message will display that the equalizing process has been finished, and **IN THIS MOMENT ONLY** is when the battery fuse holder disconnect on the UPS (Q3) can be closed.

**! BATT. SWITCH OPEN, SWITCH IT ON**



**DO NOT TRY to close Q3 battery fuse disconnect at any other time or there may be damage to the UPS.**

13. The system is now started up completely, and the UPS is protecting the critical load.



With the system running (switches turned “On”), if the inverter of any UPS is shut down or restarted the using the keypad of any UPS, all of parallel units will be turned “Off” or “On”. In both cases, the UPS still supplies output voltage at through the inverters (“On” position) or through the static bypass (“Off” position).

## 3.2 Shutdown

### 3.2.1 Inverter Disconnect

Turn the output switch (Q2) of the UPS to shut down “Off”. In the screen on LCD panel will display:

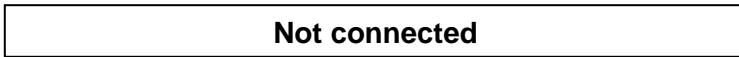

### 3.2.2 Complete Shutdown of UPS

1. Shutdown the loads.
2. Open any distribution breakers.
3. Shutdown the inverter.
  - a. Through the keypad of the control panel ((3) from **Figure 1** or **Figure 5**), go down to “CNTL” submenu, and select “OFF”.
  - b. On next screen, “ENT” to shutdown inverter.
4. Turn the output switch (Q2) to “Off” position.
5. Set the input switch (Q1a) to “Off” position.
6. Open the circuit breaker on any external battery cabinet(s) and open the fuse disconnect in the UPS (Q3).
7. To completely isolate UPS, remove power to the UPS input and the bypass. The system is now completely deactivated.

## Danger



After shutdown of the UPS, wait at least 5 minutes before performing any maintenance or service work to allow the electrolytic capacitors to be discharged.

### 3.2.3 Emergency Power Off (EPO)

Emergency Power Off (EPO) will completely shutdown unit or system of units:



When activated, the output voltage to the load is turned off.

#### 3.2.3.1 Remote Emergency Power Off (REPO)

Remote shutdown function (REPO) is activated through the terminal strip (X50). A Normally Closed contact is opened, REPO will activate and completely shut down the module.

In a parallel system, it is only necessary to connect a Remote EPO to one UPS. The communication BUS will shut down all units when any single unit REPO is activated.

#### 3.2.3.2 Local Emergency Power Off (EPO)

Local shutdown function (EPO) is activated from front panel mounted EPO button. When button is depressed, EPO will activate and completely shut down the module.

#### 3.2.3.3 End of Discharge

When the unit is in Battery Mode, it will constantly monitor the battery voltage level. When the batteries have discharge below the Low Battery level, an alarm will activate. When the batteries have discharge below the End of Discharge (EOD) level, the unit will turn off the inverter, but the controls will remain on. Once the input power is re-qualified, the unit will automatically restart and transfer to inverter.



If the input power is off for an extended period of time after EOD, it is recommended to open the battery breakers to avoid excess discharge of the batteries.

### 3.3 Maintenance Bypass Transfer

#### 3.3.1 Transfer to Manual Bypass

Procedure for passing from normal operation to manual bypass:

1. Shutdown the inverter.
  - a. Through the keypad of the control panel ((3) from **Figure 1** or **Figure 5**), go down to “CNTL” submenu, and select “OFF”.
  - b. On next screen, “ENT” to shutdown inverter.
  - c. Load is now on Static Bypass
2. Remove the screws holding the metal bracket blocking operation of the switch (See **Figure 2** or Error! Reference source not found.) and remove the metal bracket
3. Turn manual bypass switch (Q5) to “On” position.
4. Set the output switch (Q2) to “Off” position.
5. Set the Battery Fuse disconnect (Q3) to “Off”.
6. Open the circuit breaker on any external battery cabinet(s).
7. Turn input switch (Q1a) to “Off” position.



The UPS is supplying output voltage directly from the utility source through the manual bypass.

8. The UPS is completely shut down.

#### 3.3.2 Transfer to Normal Operation

Procedure for switching from manual bypass to normal operation:

1. When an external battery cabinet is connected, close the battery breaker(s).
2. Set the input switch (Q1a) to “On” position.
3. Set the output switch (Q2) to “On” position.
4. Set the manual bypass switch (Q5) to “Off” position and replace the metal bracket (BL) and screws. Load is on Static Bypass.



It is an important requirement for safety to replace the metal bracket (BL) to prevent accidental closure of Q5 which can result in interruption of power to the load and possible damage to the UPS.

5. Start up the inverter.
  - a. The startup operation will be done through the keypad of the control panel ((3) from **Figure 1** or **Figure 5**).
  - b. Select “CNTL” and Press (ENT) into control submenu,
  - c. Select “ON” and Press (ENT) once.
  - d. Screen to start the unit up will appear, select “Yes” and pressing (ENT).
6. After a few seconds (depending on the battery level), an alarm message will display, and **AT THIS MOMENT ONLY** is when the battery fuse holder disconnect on the UPS (Q3) can be closed.

**! BATT. SWITCH OPEN, SWITCH IT ON**



**DO NOT TRY to close Q3 battery fuse disconnect at any other time or there may be damage to the UPS.**

The UPS or UPS System is now online and fully protecting the load.

### **3.3.3 Emergency Transfer to Bypass**

Procedure for switching to Static Bypass if LCD is damaged:

1. Remove cover to Remote Shutdown Switch (Q6). See **Figure 2** or Error! Reference source not found.
2. Press Switch up to On position. The UPS will automatically transfer to Static Bypass.



If Remote Shutdown is up in the ON position, the inverter cannot be turned on.



## 4. Control Panel and Display

### 4.1 Basic Functions of Keyboard

The LCD front screen has touch screen functions. It also has buttons below the screen that has similar functions.

The advance (↑) and return (↓) keys, allows access to all the menus of the LCD panel, being able to move from one to another.

The right (→) or left (←) keys, allows access to the screens of all the submenus of the LCD panel, being able to move from one to another with themselves.

The Enter (ENT) key has different purposes depending on the menu.

The Escape (ESC) key will go to previous screen, unless in any screen of **Parameters** menu and setting any of them. If so, the first pulsation of Escape (ESC) key will stop blinking the value, and second one to go back to the previous screen.

### Adjust Setting Values

- 1 Press (ENT) key to activate the function setting, the figures in the screen blink.
- 2 Use right (→) or left (←) keys the select character to set.
- 3 Use (↑) and return (↓) keys select the value.
- 4 To confirm press (ENT). Next field will blink.
- 5 To continue adjust settings repeat steps 1-4 or
- 6 Press (ESC) to exit.

### 4.2 Screen Description

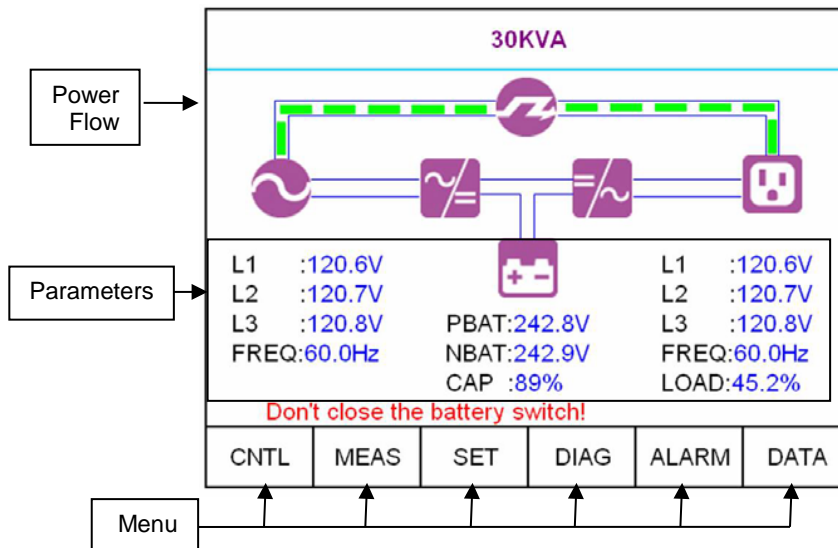

Figure 16 - Typical Main screen

### 4.2.1 Main Screen

The main screen will show the UPS power flow 1-line. This screen will display the following data:

- Input Line-Neutral Voltage (L1, L2, L3)
- Input Frequency
- Battery Positive-Half Voltage
- Battery Negative-Half Voltage
- Battery Capacity
- Output Line-Neutral Voltage (L1, L2, L3)
- Output Frequency
- Load Percentage

Using Escape (ESC) key or Home Icon from any screen of any submenu will return back to main screen.

### 4.2.2 Control (CNTL) Menu

This menu has basic controls of the UPS

- ON – Turns the UPS On (see 3.1 Start up)
- OFF – Turns the UPS Off (see 3.2 Shutdown)
- Bat. Test – Initiate a Manual Battery Test
- Back – Return to Main screen

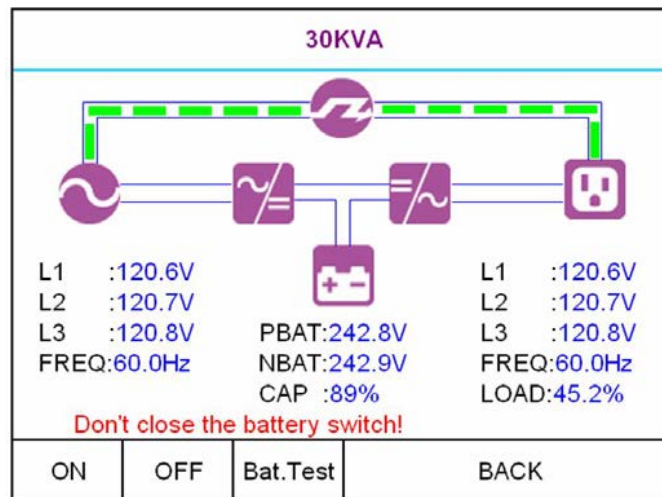

Figure 17 - Typical Control Screen

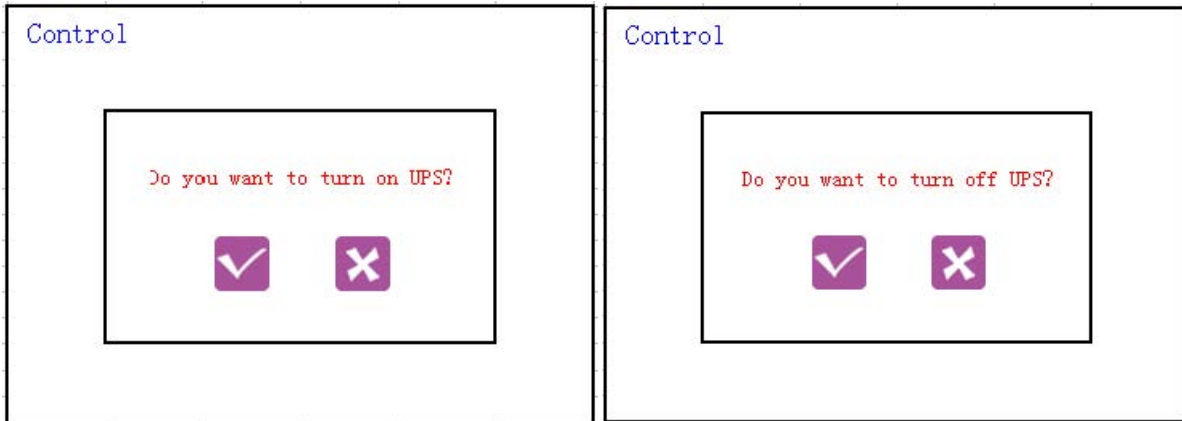

Figure 18 - UPS ON/OFF Screens

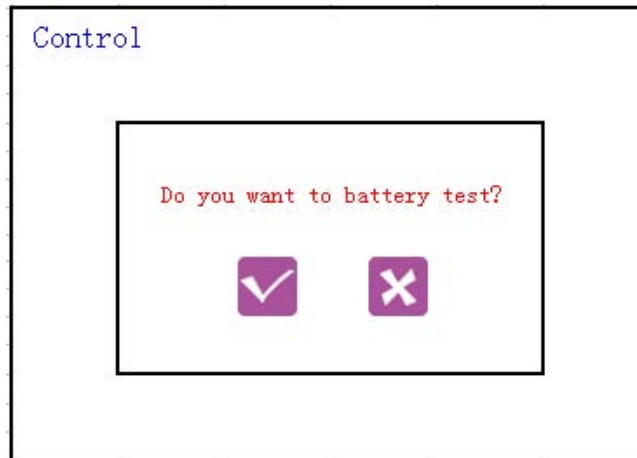

Figure 19 - Manual Battery Test Screen

#### **4.2.3 Measure (MEAS) Menu**

This menu shows measurement values:

##### **Page 1**

##### Input Voltage (V) and Current (A)

V12 - Phase A-B Voltage; V1N - Phase A-N Voltage; I1 – Phase A Current  
 V23 - Phase B-C Voltage; V2N - Phase B-N Voltage; I2 – Phase B Current  
 V13 - Phase A-C Voltage; V3N - Phase C-N Voltage; I3 – Phase C Current

##### Output Voltage (V) and Current (A)

V12 - Phase A-B Voltage; V1N - Phase A-N Voltage; I1 – Phase A Current  
 V23 - Phase B-C Voltage; V2N - Phase B-N Voltage; I2 – Phase B Current  
 V13 - Phase A-C Voltage; V3N - Phase C-N Voltage; I3 – Phase C Current

##### DC Bus Voltage (V)

P - Positive Half-String Voltage; N - Negative Half-String Voltage

##### Battery Voltage (V)

P - Positive Half-String Voltage; N - Negative Half-String Voltage

**Page 2**

Bypass Voltage (V) and Current (A)

V1N - Phase A-N Voltage; I1 – Phase A Current  
V2N - Phase B-N Voltage; I2 – Phase B Current  
V3N - Phase C-N Voltage; I3 – Phase C Current

Inverter Voltage (V) and Current (A)

V1N - Phase A-N Voltage; I1 – Phase A Current  
V2N - Phase B-N Voltage; I2 – Phase B Current  
V3N - Phase C-N Voltage; I3 – Phase C Current

Charging Current (A)

P - Positive Half-String Current; N - Negative Half-String Current

Discharging Current (A)

P - Positive Half-String Current; N - Negative Half-String Current

**Page 3**

Frequency

Input (Hz)

Bypass (Hz)

Output (Hz)

Temperature

Rectifier (°C)

Inverter (°C)

Battery (°C)

Input Apparent Power (VA) and Active Power (W)

L1: Phase A (VA); L1: Phase A (W)

L2: Phase B (VA); L2: Phase B (W)

L3: Phase C (VA); L3: Phase C (W)

Input Total Power

Total of all 3 phases (VA) & (W)

Input Power Factor

L1: Phase A; L2: Phase B; L3: Phase C

**Page 4**

Output Apparent Power (VA) and Active Power (W)

L1: Phase A (VA); L1: Phase A (W)

L2: Phase B (VA); L2: Phase B (W)

L3: Phase C (VA); L3: Phase C (W)

Output Total Power

Total of all 3 phases (VA) & (W)

Output Power Factor

L1: Phase A; L2: Phase B; L3: Phase C

Output % Load (%)

L1: Phase A; L2: Phase B; L3: Phase C

Total Load (%)

IN – Input Total Load; OUT – Output Total Load

Estimated Backup Time (Min)

Estimated of battery runtime at current load

## 4.2.4 Setting (SET) Menu

This menu shows values that can be adjusted:

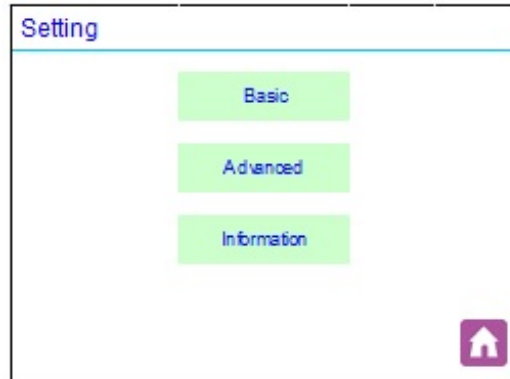

Figure 20 - Setting Menu

### 4.2.4.1 Basic Settings

Page 1

- Theme Setting – Change the color scheme of the front LCD screen
- Clock – Set time hh:mm:ss (hours/minutes/seconds)(24hr format)
- Date – Set date dd/mm/yy (day/month/year)
- Language – Set language on Front LCD screen  
(US English\UK English \Chinese\Japanese\German\Spanish\French)
- Modbus Address - (1-246)
- Service Phone Number - (XXXX-XXXXXXX)
- Service Contactor – Set name of Service Contractor
- Service Mail – Set Service Contractor's email address
- Service Address – Set Service Contractor's mailing address

Page 2

- Port 0 Baud Rate – Set Baud rate for port #0 (1200/2400/4800/9600/19200)
- Port 0 Parity – Set Parity type for Port #0 (None/Odd/Even)
- Port 0 Stop Bits – Set number of Stop Bits for Port #0 (1/2)
- Port 0 Protocol – Set protocol type for Port #0 (Sec/Modbus)
- Port 2 Baud Rate – Set Baud rate for Port #2 (1200/2400/4800/9600/19200)
- Port 2 Parity – Set Parity type for Port #2 (None/Odd/Even)
- Port 2 Stop Bits – Set number of Stop Bits for Port #2 (1/2)
- Port 2 Protocol – Set protocol type for Port #2 (Sec/Modbus)

Page 3

- Automatic Battery Test Setting:
  - Type – How often the battery test is performed (Disabled/Weekly/Monthly/Yearly)
  - Weekday – If Type is set to “Weekly”, sets day of the week the test will start (Mon/Tue/Wed/Thu/Fri/Sat/Sun)
  - Hour:Minute – If automatic battery test is enabled, set time of day the test starts (hh:mm – 24-hr format)
  - Month/Day – If battery test is set for “Monthly” or “Yearly”, sets month and day of month the test will start.
- Application Setting – Set to 3Ph\_4Wire
- Buzzer permanently muted – “Yes” will disable audible alarm, “No” will allow audible alarms

#### 4.2.4.2 Advanced Setting



Password (01899) must be entered to activate write access to any Advance menu options.

##### Rate Values

These setting are not recommended to be changed without factory authorization.

##### Parameters

These setting are not recommended to be changed without factory authorization except for the following if unit is part of parallel system: Page 3 – Parallel Address, Parallel Unit, and Parallel Total Number

##### Calibration

These setting are not recommended to be changed without factory authorization.

##### System Initial

These setting are not recommended to be changed without factory authorization.

#### 4.2.4.3 Information

Shows the configuration of UPS

##### Page 1

LCD Version  
DSP Version  
UC Version  
Serial Number  
Service Phone\*  
Service Contractor\*  
Service email\*  
Service Address\*

##### Page 2

Input Voltage\*\*  
Output Voltage\*\*  
IP. V Min Margin\*\*  
IP.V. Max Margin\*\*  
Bps. V Min Margin\*\*  
Bps. V. Max Margin\*\*  
DC Bus Voltage\*\*  
OP. Current\*\*  
Battery Charging Current\*\*  
UPS Configuration\*\*

\*Service Information is set in Basic Setting Menu (see 4.2.4.1 Basic Settings)

\*\*Rated Values are set in Rated Values settings (see Advanced Settings)

#### 4.2.3 ALARM

When Alarms appear in the Main Menu, only one alarm is visible. The Alarm Menu will list all active alarms. Appendix A lists all the possible alarms that can be displayed.

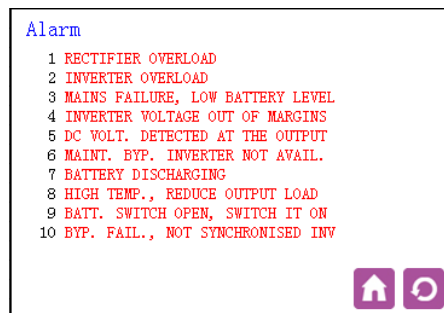

Figure 21 - Alarm Screen

## 5. UL924 Emergency Lighting Systems

The Staco FirstLine PLT can be used as part of an approved UL924 Emergency Lighting system.

**Table 4 – Battery Models approved for UL924**

<b>CSB</b>	<b>FIAMM</b>	<b>Energys</b>	<b>C&amp;D Technologies</b>
HR1234W HR1251W HR1290W HR12150W HR12200W HRL12540W	12FLX200 12FLX540	12HX540	UPS12-540MR

**Table 5 – UL924 Approved Systems**

<b>Staco UL924 Model #</b>	<b>kW</b>	<b>UPS Internal Batteries</b>	<b>External Batteries required</b>
FLP-924-09T-xxxx	9	(1) string of 34W	(1) string of 150W
FLP-924-13T-xxxx	13	(1) string of 90W	(1) string of 200W
FLP-924-18T-xxxx	18	None	(2) strings of 200W
FLP-924-27T-xxxx	27	None	(3) strings of 200W
FLP-924-36T-xxxx	36	None	(4) strings of 200W
FLP-924-45T-xxxx	45	None	(2) strings of 540W
FLP-924-54T-xxxx	54	None	(2) strings of 540W

See Section 7.4 **UL924 UPS Weights** for weights of UL924 UPS unit.

## 6. Maintenance

### 6.1 Basic Maintenance Guide



The uninterruptible power system is designed and produced to last, even in the most severe service conditions. It is an electronic power unit, which requires periodic maintenance. Moreover, some components have a limited lifespan and as such must be periodically checked and replaced should conditions so dictate: in particular the batteries, the fans and in some cases the electrolytic capacitors. It is therefore recommended to implement a preventive maintenance program with a specialized personnel authorized by the manufacturer. Our Technical Support Team will be happy to recommend the various personalized options for preventive maintenance.

#### **6.1.1 Periodic maintenance (to be carried out by trained personnel and with doors closed)**

The following operations should be carried out periodically (e.g. once a month, or more frequently in particularly difficult environmental conditions):

- Ensure that the air intake slots (located on the front door and at the back of the cabinet) and the output grilles located on the top of the cabinet are clean;
- Perform a battery test.

#### **6.1.2 Maintenance inside the UPS (factory authorized personnel only)**

##### **Danger**



Maintenance inside the UPS may only be carried out by trained personnel. The UPS is designed to power the load when it is disconnected from the mains power supply.

**High voltage is present inside the UPS even when the mains power supply and the battery have been disconnected.**

After disconnecting the input utility and the battery source, trained service personnel must wait at least ten minutes for the capacitors to discharge before working on the inside of the UPS.

#### **6.1.3 Ordinary maintenance for batteries (trained personnel only)**

The system automatically controls the efficiency of the batteries every 24 hours, and sounds an alarm when the efficiency is lower than that calculated, according to the stored capacity value.

The lifespan of the batteries is linked to the operating temperature and to the number of charge and discharge cycles the battery has experienced.

The capacity is not constant, but increases after some charge and discharge cycles; it then remains constant for several hundreds of cycles before decreasing permanently.

Preventive maintenance of the battery:

- Keep the operating temperature within the range of 20 - 25°C;
- Perform two or three discharge and charge cycles during the first month of use;
- Repeat this operation every six months after the first month of use.

##### **Danger**



Maintenance inside the UPS may only be carried out by trained personnel.

Since the batteries are a source of energy, opening the battery circuit breaker/disconnect does not eliminate the voltage inside the battery cabinet. **DO NOT TRY TO ACCESS THE INSIDE OF THE BATTERY CABINET. THERE ARE ALWAYS DANGEROUS VOLTAGES FROM THE BATTERIES.** If the batteries are thought to be faulty in any way, please contact Staco technical support.



## Warning



If the batteries need to be replaced, this must be done by **factory authorized personnel**. The replaced parts must be sent to a specialized company for disposal by means of recycling. Batteries are classified by law as “toxic waste”.

## 6.2 Internal Battery Replacement

## Danger



The internal battery compartment contains high voltage and should only be serviced by qualified technical personnel. Battery trays are very heavy. Removing a battery tray from the UPS should only be done with the use of a mechanical lift (fork lift).

When replacing batteries use only the same type and size rating as the battery being replaced.

1. Verify the UPS is completely off and the mains power is disconnected. Open the battery fuse disconnect Q3.
2. Remove the front panels from the cabinet.
3. Locate the battery connectors between the battery trays as shown in **Figure 22**.

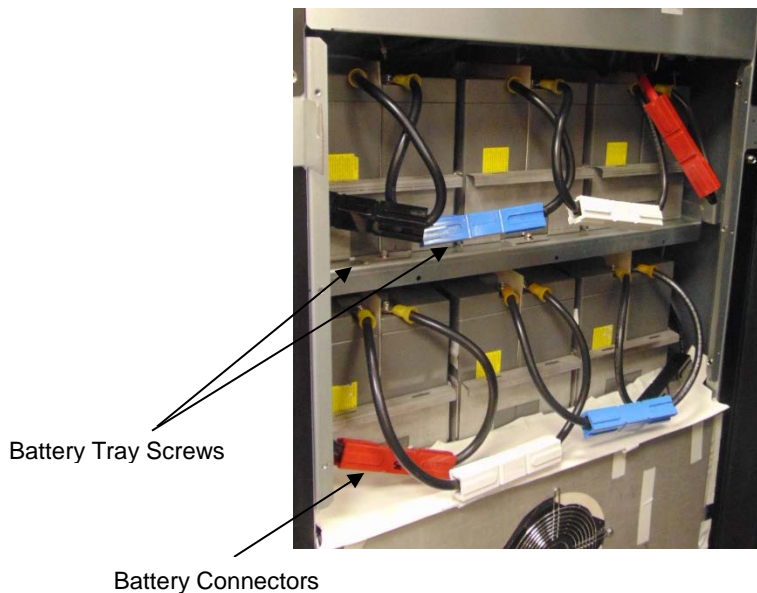

**Figure 22 - UPS Internal Battery trays**

4. Pull the two halves of the battery connectors apart to disconnect the batteries.
5. The batteries are mounted into trays that bolt down to the chassis as shown in **Figure 22**. Remove all of these bolts.



**Before disconnecting any battery wires they should be marked to identify where they were connected.** The battery string is made up of 36 batteries with three connections at Positive, Center Tap, and Negative. The wires from the battery connector are as follows: Red to Positive, Blue to center tap, and black to Negative.

6. The trays are now free to completely remove from the battery compartment.
7. Insure that the replacement batteries are installed in the trays in exactly the same orientation as the original factory installation.
8. Install the battery trays starting with the lowest tray. Insure the proper wire termination is made based on the color of the connector.
9. Once all trays are installed and all of the connections are made you can reconnect the multi-colored battery connector halves.

Replace the cabinet front and follow the startup procedure to restart the UPS. See **3.1 Start up**

### 6.3 Recommended Replacement Intervals

The Staco UPS has a long design life. Due to the characteristics of the part, not the design of the UPS, certain components used in the design have a limited life, even with proper maintenance.



*Service and maintenance work must be performed only by factory authorized personnel.*

Staco recommends these limited-life components be periodically inspected and replaced before the expected expiration of their life cycle. The recommended replacement schedule is an estimate only. The life of these parts depends on site conditions such as ambient temperature, load profile, cleanliness of environment and other factors. See Section **7.1 Technical Specifications**

Staco Recommends a Factory Authorized Preventative Maintenance review is schedule at least once a year.

Component	Recommend Replace in:
Fans	4-6 years
Batteries	4 years
AC Filter Capacitors	4-6 years
DC Filter Capacitors	4-6 years

**Table 6 - Recommended Replacement Intervals**

The functional lifetime of VRLA batteries is significantly affected by the temperature at which they are stored and operated. Ideally, VRLA batteries should be used in a 25° C (77° F) environment. For every 8.3° C (15° F) increase in temperature, the life expectancy of a battery will be halved.

Exposure to temperatures in excess of 32° C (90° F) should be limited to no more than 30 days per year. Under no circumstances should the VRLA battery be exposed to temperatures over 40° C (104° F) which can lead to thermal runaway, a condition that damages the battery. Thermal runaway can cause batteries to swell. If the battery cases burst, the hazardous contents may be exposed.

Maintaining proper ambient temperature usually requires installing the product in a temperature controlled space. Equipment rooms without cooling systems do not generally maintain the proper conditions for good battery life.

See Staco's website for warranty details:

<http://www.stacoenergy.com/support/literature-download-center.html>

## 7. Specifications

### 7.1 Technical Specifications

<b>Input</b>	
Voltage	208 or 480 VAC, Three Phase, 3 or 4 wire plus ground
Range	+15% / -20% ( Battery Discharge@-15% with full load)
Frequency	50 <sup>1</sup> /60Hz +/- 5.0 Hz
Power Factor	0.99 at 100% load, 0.98 minimum at 50% load
Reflected Current Distortion (THD)	Less than 1% (100% load), Less than 2% (50% load), less than 5% (10% load)
Input Current	<b>See 7.2 Rated Currents and Recommend Field Wiring Information</b>
<b>Output</b>	
Voltage	208 or 480 VAC, Three Phase, 3 or 4 wire plus ground
Static Voltage Regulation	+/- 2%
Voltage Transient Response	Voltage transient response shall not exceed the following, and shall recover to 95% within 10 milliseconds: a) <5% for 3-phase RMS average for 100% step load b) +/- 1% (loss or return of AC input)
Frequency (inverter synchronous)	60Hz (tracks frequency of static bypass source) +/-, 0.5, 1.0, 2.0, 5.0 Hz (user settable).
Frequency Slew Rate	± 10 Hz per second (inverter synchronized to static bypass)
Free Running Frequency	50 <sup>1</sup> /60Hz +/- 0.01Hz (on battery or asynchronous)
Voltage Distortion (THD)	Less than 1% (Linear load), Less than 2% with crest factor 2.5 to 1
Inverter Overload	125 % for 10 min, 150 % for 60 sec
Bypass Overload	400% for 10 seconds , 1000% for half line cycle
Bypass Input Synch Voltage Range	+12%/-15%
Bypass Input Frequency Tracking Range	+/- 5Hz
Output Current	<b>See 7.2 Rated Currents and Recommend Field Wiring Information</b>
Heat Rejection (BTU/Hr) @ 100% load	<b>See 7.3 BTU/hr &amp; Weight</b>
<b>Environmental</b>	
Altitude	< 2000 meters Derate load capability above 1000 meters 1% per 100 meters
Operating Temperature	0 ~ 40°C
Audible Noise (dbA)	<75
<b>General</b>	
Dimensions (HxWxD)	10-40kVA: 72.41 in (1840mm) x 23.13 in (588mm) x 34.47 in (876mm) 50-60kVA: 76.75 in (1950mm) x 34.13 in (867mm) x 34.47 in (876mm)
Weight	<b>See 7.3 BTU/hr &amp; Weight</b>
Standards	UL listed to 1778, CUL to CSA C22.2, NEMA PE-1, ASME, ASA-C-39.1-1984, FCC Part 15 Subpart J Class B, NEC, OSHA, IEEE587, ANSI C 62.41-1980, ISO9000, 14000

Notes:

1. See Staco Representative for versions that allow 50Hz operations.

## 7.2 Rated Currents and Recommend Field Wiring Information

KVA	INPUT VOLTAGE	OUTPUT VOLTAGE	CURRENT (AMPS)				RECOMMENDED CABLES <sup>1,2,3</sup>			
			NOMINAL INPUT	MAX INPUT	OUTPUT	DC	RECTIFIER	OUTPUT	BYPASS	DC
10	208Y/120	208Y/120	27	33	28	27	10AWG	10AWG	10AWG	10AWG
10	208Δ	208Y/120	28	34	28	27	10AWG	10AWG	10AWG	10AWG
10	480Δ	208Y/120	12	15	28	27	14AWG	10AWG	14AWG	10AWG
10	480Y/277	208Y/120	12	15	28	27	14AWG	10AWG	14AWG	10AWG
10	480Y/277	480Y/277	12	15	12	27	14AWG	14AWG	14AWG	10AWG
10	208Δ	480Y/277	28	34	12	27	8AWG	14AWG	8AWG	10AWG
10	208Y/120	480Y/277	28	33	12	27	10AWG	14AWG	8AWG	10AWG
10	480Δ	480Y/277	12	15	12	27	14AWG	14AWG	14AWG	10AWG
15	208Y/120	208Y/120	41	49	42	40	6AWG	6AWG	6AWG	8AWG
15	208Δ	208Y/120	42	50	42	40	6AWG	6AWG	6AWG	8AWG
15	480Δ	208Y/120	18	22	42	40	12AWG	6AWG	12AWG	8AWG
15	480Y/277	208Y/120	18	22	42	40	12AWG	6AWG	12AWG	8AWG
15	480Y/277	480Y/277	18	22	18	40	12AWG	12AWG	12AWG	6AWG
15	208Δ	480Y/277	42	51	18	40	6AWG	12AWG	6AWG	6AWG
15	208Y/120	480Y/277	41	50	18	40	6AWG	12AWG	6AWG	6AWG
15	480Δ	480Y/277	18	22	18	40	12AWG	12AWG	12AWG	6AWG
20	208Y/120	208Y/120	54	65	56	53	4AWG	4AWG	4AWG	4AWG
20	208Δ	208Y/120	56	67	56	53	4AWG	4AWG	4AWG	4AWG
20	480Δ	208Y/120	24	29	56	53	10AWG	4AWG	10AWG	4AWG
20	480Y/277	208Y/120	24	29	56	53	10AWG	4AWG	10AWG	4AWG
20	480Y/277	480Y/277	24	29	24	54	10AWG	10AWG	10AWG	4AWG
20	208Δ	480Y/277	57	68	24	54	4AWG	10AWG	4AWG	4AWG
20	208Y/120	480Y/277	55	66	24	54	4AWG	10AWG	4AWG	4AWG
20	480Δ	480Y/277	24	30	24	54	10AWG	10AWG	10AWG	4AWG
30	208Y/120	208Y/120	81	98	84	80	2AWG	2AWG	2AWG	3AWG
30	208Δ	208Y/120	83	101	84	80	2AWG	2AWG	2AWG	3AWG
30	480Δ	208Y/120	36	43	84	80	8AWG	2AWG	8AWG	3AWG
30	480Y/277	208Y/120	36	43	84	80	8AWG	2AWG	8AWG	3AWG
30	480Y/277	480Y/277	36	44	36	81	8AWG	8AWG	8AWG	2AWG
30	208Δ	480Y/277	85	102	36	81	2AWG	8AWG	2AWG	2AWG
30	208Y/120	480Y/277	83	100	36	81	2AWG	8AWG	2AWG	2AWG
30	480Δ	480Y/277	37	44	36	81	8AWG	8AWG	8AWG	2AWG
40	208Y/120	208Y/120	109	131	111	106	1/0	1/0	1/0	1/0
40	208Δ	208Y/120	111	134	111	106	1/0	1/0	1/0	1/0
40	480Δ	208Y/120	48	58	111	106	6AWG	1/0	6AWG	1/0
40	480Y/277	208Y/120	48	58	111	106	6AWG	1/0	6AWG	1/0
40	480Y/277	480Y/277	48	59	48	108	6AWG	6AWG	6AWG	1/0
40	208Δ	480Y/277	113	136	48	108	1/0	6AWG	1/0	1/0
40	208Y/120	480Y/277	110	133	48	108	1/0	6AWG	1/0	1/0
40	480Δ	480Y/277	49	59	48	108	6AWG	6AWG	6AWG	1/0
50	208Y/120	208Y/120	143	172	139	133	3/0	2/0	2/0	2/0
50	208Δ	208Y/120	147	176	139	133	3/0	2/0	2/0	2/0
50	480Δ	208Y/120	64	76	139	133	4AWG	2/0	4AWG	2/0
50	480Y/277	208Y/120	63	76	139	133	4AWG	2/0	4AWG	2/0
50	208Δ	480Y/277	151	179	60	136	3/0	4AWG	3/0	2/0
50	208Y/120	480Y/277	147	177	60	136	3/0	4AWG	3/0	2/0
50	480Δ	480Y/277	65	78	60	136	4AWG	4AWG	4AWG	2/0

KVA	INPUT VOLTAGE	OUTPUT VOLTAGE	CURRENT (AMPS)				RECOMMENDED CABLES <sup>1,2,3</sup>			
			NOMINAL INPUT	MAX INPUT	OUTPUT	DC	RECTIFIER	OUTPUT	BYPASS	DC
50	480Y/277	480Y/277	64	77	60	136	4AWG	4AWG	4AWG	2/0
60	208Y/120	208Y/120	167	200	167	159	4/0	4/0	4/0	3/0
60	208 $\Delta$	208Y/120	171	205	167	159	4/0	2/0	4/0	3/0
60	480 $\Delta$	208Y/120	74	89	167	159	3AWG	2/0	3AWG	3/0
60	480Y/277	208Y/120	73	88	167	159	3AWG	2/0	3AWG	3/0
60	208 $\Delta$	480Y/277	173	208	72	162	4/0	4AWG	4/0	4/0
60	208Y/120	480Y/277	169	203	72	162	4/0	4AWG	4/0	4/0
60	480 $\Delta$	480Y/277	75	90	72	162	43AWG	4AWG	3AWG	4/0
60	480Y/277	480Y/277	74	89	72	162	3AWG	4AWG	3AWG	4/0

1: Based on 75°C copper wire.

2: Recommended cable sized based on THW cables at 30°C ambient (NEC Table 310.16). If different cables are used or installed at higher ambient, the cable size need to be reviewed.

3: Any external battery wires use reinforced insulation or double insulated wire.

### 7.3 BTU/hr & Weight

KVA	INPUT VOLTAGE	OUTPUT VOLTAGE	NUMBER OF INTERNAL BATTERY STRINGS	MAXIMUM WEIGHT	BTU/hr	Notes
10	208Y/120	208Y/120	0	659	2,400	1,2
10	208Y/120	208Y/120	1	1230	2,400	1,3,4
10	208	208Y/120	1	1379	3,200	1,3
10	480	208Y/120	1	1409	3,200	1,3
10	480Y/277	208Y/120	1	1299	2,900	1,3
10	480Y/277	480Y/277	1	1399	3,400	1,3
10	208	480Y/277	1	1479	3,700	1,3
10	208Y/120	480Y/277	1	1299	2,900	1,3
10	480	480Y/277	1	1509	3,700	1,3
10	208Y/120	208Y/120	2	1770	2,400	1,3
15	208Y/120	208Y/120	0	659	3,500	1,2
15	208Y/120	208Y/120	1	1230	3,500	1,3,4
15	208	208Y/120	1	1449	4,800	1,3
15	480	208Y/120	1	1449	4,800	1,3
15	480Y/277	208Y/120	1	1399	4,300	1,3
15	480Y/277	480Y/277	1	1599	5,000	1,3
15	208	480Y/277	1	1649	5,600	1,3
15	208Y/120	480Y/277	1	1399	4,300	1,3
15	480	480Y/277	1	1649	5,600	1,3
15	208Y/120	208Y/120	2	1770	3,500	1,3
20	208Y/120	208Y/120	0	659	4,700	1,2
20	208Y/120	208Y/120	1	1230	4,700	1,3,4
20	208	208Y/120	1	1429	6,400	1,3
20	480	208Y/120	1	1499	6,400	1,3
20	480Y/277	208Y/120	1	1429	5,700	1,3
20	480Y/277	480Y/277	1	1659	6,700	1,3
20	208	480Y/277	1	1659	7,400	1,3
20	208Y/120	480Y/277	1	1429	5,700	1,3
20	480	480Y/277	1	1729	7,400	1,3
20	208Y/120	208Y/120	2	1770	4,700	1,3
30	208Y/120	208Y/120	0	659	7,000	1,2
30	208Y/120	208Y/120	1	1230	7,000	1,3,4
30	208	208Y/120	1	1629	9,500	1,3
30	480	208Y/120	1	1629	9,500	1,3
30	480Y/277	208Y/120	1	1464	8,500	1,3
30	480Y/277	480Y/277	1	1729	10,000	1,3
30	208	480Y/277	1	1894	11,100	1,3
30	208Y/120	480Y/277	1	1464	8,500	1,3
30	480	480Y/277	1	1894	11,100	1,3
30	208Y/120	208Y/120	2	1770	7,000	1,3
40	208Y/120	208Y/120	0	659	9,300	1,2
40	208Y/120	208Y/120	1	1230	9,300	1,3,4
40	208	208Y/120	1	1633	12,700	1,3
40	480	208Y/120	1	1649	12,700	1,3
40	480Y/277	208Y/120	1	1469	11,300	1,3
40	480Y/277	480Y/277	1	1739	13,300	1,3
40	208	480Y/277	1	1903	14,700	1,3
40	208Y/120	480Y/277	1	1469	11,300	1,3

KVA	INPUT VOLTAGE	OUTPUT VOLTAGE	NUMBER OF INTERNAL BATTERY STRINGS	MAXIMUM WEIGHT	BTU/hr	Notes
40	480	480Y/277	1	1919	14,700	1,3
40	208Y/120	208Y/120	2	1770	9,300	1,3
50	208Y/120	208Y/120	0	881	21,000	1
50	208	208Y/120	0	1461	25,500	1
50	480	208Y/120	0	1291	25,500	1
50	480Y/277	208Y/120	0	1291	25,500	1
50	208	480Y/277	0	1871	30,100	1
50	208Y/120	480Y/277	0	1291	25,500	1
50	480	480Y/277	0	1701	30,100	1
50	480Y/277	480Y/277	0	1701	30,100	1
60	208Y/120	208Y/120	0	881	18,300	1
60	208	208Y/120	0	1439	23,500	1
60	480	208Y/120	0	1441	23,500	1
60	480Y/277	208Y/120	0	1447	21,400	1
60	208	480Y/277	0	2005	26,600	1
60	208Y/120	480Y/277	0	1447	21,400	1
60	480	480Y/277	0	2007	26,600	1
60	480Y/277	480Y/277	0	2013	24,500	1

Notes:

1. All weights are in pounds
2. Base unit with no batteries.
3. Weights are with 90W batteries.
  - For 51W batteries, subtract 234lbs per string
  - For 34W batteries, subtract 341lbs per string.
4. Includes second battery trays for optional 2<sup>nd</sup> battery string

## 7.4 UL924 UPS Weights

KVA	INPUT VOLTAGE	OUTPUT VOLTAGE	UL924 UPS WEIGHT
10	208Y/120	208Y/120	858
10	208	208Y/120	1038
10	480	208Y/120	1068
10	480Y/277	208Y/120	958
10	480Y/277	480Y/277	1058
10	208	480Y/277	1138
10	208Y/120	480Y/277	958
10	480	480Y/277	1168
15	208Y/120	208Y/120	1199
15	208	208Y/120	1449
15	480	208Y/120	1449
15	480Y/277	208Y/120	1399
15	480Y/277	480Y/277	1599
15	208	480Y/277	1649
15	208Y/120	480Y/277	1399
15	480	480Y/277	1649
20	208Y/120	208Y/120	659
20	208	208Y/120	889
20	480	208Y/120	959
20	480Y/277	208Y/120	889
20	480Y/277	480Y/277	1119
20	208	480Y/277	1119
20	208Y/120	480Y/277	889
20	480	480Y/277	1189
30	208Y/120	208Y/120	659
30	208	208Y/120	1089
30	480	208Y/120	1089
30	480Y/277	208Y/120	924
30	480Y/277	480Y/277	1189
30	208	480Y/277	1354
30	208Y/120	480Y/277	924
30	480	480Y/277	1354
40	208Y/120	208Y/120	659
40	208	208Y/120	1093
40	480	208Y/120	1109
40	480Y/277	208Y/120	929
40	480Y/277	480Y/277	1199
40	208	480Y/277	1363
40	208Y/120	480Y/277	929
40	480	480Y/277	1379
50	208Y/120	208Y/120	881
50	208	208Y/120	1461
50	480	208Y/120	1291
50	480Y/277	208Y/120	1291
50	208	480Y/277	1701
50	208Y/120	480Y/277	1871
50	480	480Y/277	1291
50	480Y/277	480Y/277	1701
60	208Y/120	208Y/120	881



<b>KVA</b>	<b>INPUT VOLTAGE</b>	<b>OUTPUT VOLTAGE</b>	<b>UL924 UPS WEIGHT</b>
60	208	208Y/120	1439
60	480	208Y/120	1441
60	480Y/277	208Y/120	1447
60	208	480Y/277	2013
60	208Y/120	480Y/277	2005
60	480	480Y/277	1447
60	480Y/277	480Y/277	2007

## Appendix A – Alarms

<u>Alarm #</u>	<u>Alarm Name</u>	<u>Definition</u>
1	Rectifier Overload.	Indicates that the rectifier is overloaded. The rectifier overload appears when the input current of any phase is greater than the following ratio: $I_{in-ovl} = 0,326 \times P_{out} / V_{out\_p-n}$ Where: - $I_{in-ovl}$ is Overload Input Current (A) - $P_{out}$ is Rated Output Apparent Power (VA) - $V_{out\_p-n}$ is Rated Output Voltage phase-to-neutral (V)
2	Inverter Overload.	Indicates that the inverter is overloaded. The inverter overload appears either when the output current of any phase is greater than the rated output current $I_{out-ovl} = P_{out} / (V_{out\_p-n} \times 3)$ Where: <ul style="list-style-type: none"> <li>• <math>I_{out}</math> is rated Output Current (A)</li> <li>• <math>P_{out}</math> is Rated Output Apparent Power (VA)</li> <li>• <math>V_{out\_p-n}</math> is Rated Output Voltage phase-to-neutral (V)</li> </ul> or when the total output active power is greater than the following formula: $P_{act\_out-ovl} = P_{out} \times 0,8$ Where: <ul style="list-style-type: none"> <li>• <math>P_{act\_out-ovl}</math> is the Overload Output Active Power (W)</li> <li>• <math>P_{out}</math> is Rated Output Apparent Power (VA)</li> </ul>
3	Mains Failure. Battery Low Level.	Appears when the input the unit is under main failure condition and the level of battery is lower than 11.5V/bat.
4	Inverter Voltage Out of Margins.	Appears when the inverter output voltage phase to neutral in any phase is out of margins over +/-6%.
5	DC Voltage Detected at the Output.	Appears when there is an offset voltage higher than 5V, in any phase of the inverter output voltage phase to neutral.
6	Maintenance Bypass. Inverter Not Available.	When the maintenance bypass switch is ON the UPS inverter will not be available.
7	Battery Discharging.	The mains failure occurs when any phase to neutral voltage is out of the set margins (Default: +15%/-20%) or the input frequency is out of the set margins (Default: ± 0.5Hz).
8	High Temperature. Reduce Output Load.	When the inverter or PFC temperature sensors measure temperatures over the programmed values (Default: 70°C).
9	Battery Switch Open. Switch it ON.	Signals to turn Battery switch to ON position when the battery switch is OFF and the DC bus is charged to the battery voltage level.
10	Bypass Failure. Not Synchronised Inverter.	Indicates that the bypass input voltage (Default: +12%/-17%) or the bypass input frequency (Default: ±0.5Hz.) are out of programmable margins.
11	Unit on Bypass. Initialise UPS.	The UPS is on bypass for any reason. It must be restarted by display keypad.
12	Some Unit(s) Blocked due to Maintenance Bypass.	<u>For parallel systems.</u> It appears when some UPS of the parallel system block because the maintenance bypass switch of any unit is switched ON.
13	CAN BUS 1 Communication Failure.	Indicates that the CAN BUS #1 fails. This communication channel is used for remote control.
14	CAN BUS 2 Communication Failure.	<u>For parallel systems.</u> Indicates that the CAN BUS #2 fails. This channel is used for data communication between UPS's.
15	End of Battery Life.	The estimated end of life of the battery bank.
16	Battery Temperature too High.	The temperature of battery cabinet (in case of separate battery cabinet) or battery place (in case of battery are located inside the UPS) is higher than 40°C.
17	Battery Test Not Succeeded.	Battery test (automatic or manual) is unsuccessfully.

<b>Alarm #</b>	<b>Alarm Name</b>	<b>Definition</b>
18	Battery Disconnection. Shutdown & Restart.	Two possible reasons: <ul style="list-style-type: none"> <li>• During the unit start up, message appears indicating that the battery switch can be switched ON. After some period of time without switching ON, this alarm appears.</li> <li>• When the unit is running under normal conditions and the battery switch is switched OFF.</li> </ul>
19	Mains Phase Rotation. UPS Start Disabled.	Input phase rotation error is detected and the startup procedure is inhibited.
20	Bypass Phase Rotation. UPS Start Disabled.	Bypass phase rotation error is detected and the startup procedure is inhibited.
21	Input Voltage Wrong. Rectifier Stop.	Any rectifier input voltage phase to neutral is out of the set margins (Default: +15%/–20%) or the rectifier input frequency is out of the set margins (Default: ± 0,5Hz). Then the rectifier is shut down.
22	Rectifier Desaturation Rectifier Stop.	Any IGBT in the rectifier side, desaturates the number of times programmed by display (Default: 50).
23	DSP Internal Error. Rectifier Stop.	Appears when there is a DSP Internal Error* in the rectifier module, shutting down the rectifier immediately. There will be 3 more retries before the rectifier blocking.
24	Input Phase Rotation. Rectifier Stop.	When a mains phase rotation error is detected and the rectifier is attempted to be turned ON, an input phase rotation alarm appears shutting down the rectifier.
25	Inverter Desaturation. Inverter Stop.	Appears when any IGBT in the inverter side, de-saturates the number of times programmed by display (Default: 200).
26	Inverter Overload. Inverter Stop.	When the inverter output is overloaded. Depending on the level of this overload, the inverter will be shut down after some time according to the UPS overload curve.
27	Inverter Stopped due to Shutdown.	When an external shutdown signal is enabled. The inverter will shut down.
28	Maintenance Bypass. Inverter Stop.	When the inverter is running and the maintenance bypass switch is turned ON the inverter shuts down immediately.
29	Parallel System Disconnection. Inverter Stop.	<u>For parallel systems.</u> Appears when, in a parallel system, one UPS goes to battery mode. The inverter will shut down.
30	High Overload. Inverter Stop.	<u>For parallel systems.</u> This message indicates that one UPS is running over 160% of load in a parallel system.
31	Overtemperature. Inverter Stop.	When an over temperature is detected by the PFC or inverter temperature sensors. After 1 minute, the inverter will be turned off automatically. If over temperature condition remains after another 1 minute with the rectifier working, rectifier is also blocked ( <a href="#">see Alarm 60</a> ).
32	Rectifier Overload. Inverter stop	The rectifier is overloaded, depending on the level of this overload, the inverter will be shut down after some time according to the rectifier overload curve. If this overload is still present with the inverter switched off, the rectifier will be blocked after 30 seconds and a blocking alarm 61 will appear.
33	DSP Internal Error. Inverter Stop.	This alarm appears when there is a DSP Internal Error* in the inverter module, shutting down the inverter immediately. There will be 4 more retries before the inverter blocking.
34	Output Short-circuit. Inverter Stop.	Appears when an output short-circuit is detected limiting the output RMS current up to the set value (Default: 150% of nominal current). The short-circuit is detected when the output voltage phase to neutral is lower than 8% of nominal voltage. The system will retry restart two times.
35	Bypass Phase Rotation. Inverter Stop.	With the inverter is running and a bypass phase rotation error, the inverter will shut down.

<b>Alarm #</b>	<b>Alarm Name</b>	<b>Definition</b>
36	Low Battery. UPS Stop.	Appears when there is a DSP Internal Error* in the UPS module, shutting down the UPS immediately. There will be 2 more retries before the UPS blocking.
37	DSP Internal Error. UPS Stop.	In battery mode, the battery bank reaches the 10.5V/bat. This is the end of backup time, shutting down the UPS.
38	Emergency Power Off. No Output Voltage.	The EPO (Emergency Power Off) switch is ON. The UPS and the static bypass are switched off and no AC voltage present at the output anymore.
39	Output Short-circuit. No Output Voltage.	Appears after detecting output short-circuit 3 times. Then the UPS and the static bypass are switched off and no AC voltage present at the output anymore.
40	DSP Internal Error. UPS Block All.	Appears when there is a DSP Internal Error* in the UPS module, for three times shutting down the UPS. The UPS blocks including the bypass, so no AC voltage present at the output anymore.
41	DC BUS Voltage Wrong. Rectifier Block.	This alarm appears when there is one of the following conditions: <ul style="list-style-type: none"> <li>• Positive DC bus voltage over 275V.</li> <li>• Positive DC bus voltage less than 200V.</li> <li>• Negative DC bus voltage over -275V (absolute value).</li> </ul>
42	Rectifier Blocked. BLK. UPS -> BLK Rectifier.	Appears when the UPS is blocked for any reason. This condition also blocks the rectifier.
43	Rectifier Desaturations. Rectifier Block.	After 3 attempts to shut down the rectifier for desaturation and retry.
44	Voltage Ramp Error. Rectifier Block.	An error in the initial rectifier ramp is detected during the PFC start up.
45	DSP Execution Error. Rectifier Block.	There is a command from the microprocessor to the DSP, with no response from the rectifier module of the DSP.
46	DSP Internal Error. Rectifier Block.	After 4 attempts shutting down the rectifier because of DSP Internal Error* in the rectifier module.
47	Contactors Test Failure. Rectifier Block.	The input contactor test failed during start-up.
48	Voltage Ramp Error. Inverter Block.	The output voltage ramp doesn't work properly during the inverter start up the inverter will be blocked ( <a href="#">See Alarm 67</a> ).
49	Output DC Voltage. Inverter Block.	Appears when there is an offset voltage higher than 8V, in any phase of the inverter output voltage phase to neutral. Then the inverter will be blocked.
50	Inverter Blocked. BLK. UPS -> BLK Inverter.	Appears when the UPS is blocked for any reason. This condition blocks also the inverter.
51	Inverter Desaturations. Inverter Block.	After 3 attempts shutting down the inverter for desaturation and retry.
52	DSP Execution Error. Inverter Block.	There is a command from the microprocessor to the DSP, with no response from the inverter module of the DSP. The inverter will block.
53	DSP Internal Error. Inverter Block.	After 5 attempts shutting down the inverter because of DSP Internal Error* in the inverter module.
54	UPS Blocked. BLK. Rectifier -> BLK. UPS.	Appears when the rectifier is blocked for some reasons that can also blocks the UPS.
55	Internal Initialisation Error. UPS Block (DSP).	Appears when the DSP doesn't response to the microprocessor during the initial procedure before the start up.
56	Internal Execution Error. UPS Block (DSP).	There is a command from the microprocessor to the DSP, with no response from the UPS module of DSP. The UPS will block.
57	UPS Blocked. BLK. Inverter -> BLK. UPS.	Appears when the inverter is blocked for some reasons that can also blocks the UPS.
58	Internal Communication. UPS Block (DSP).	There is an internal error in the communication channel between microprocessor and DSP.
59	Parallel System Discharging. UPS Block.	<u>For parallel systems.</u> Appears when one UPS goes to battery mode. After some period of time, the UPS will shut down.

<b>Alarm #</b>	<b>Alarm Name</b>	<b>Definition</b>
60	UPS Overtemperature. UPS Block.	When an overtemperature is detected by the PFC or inverter temperature sensors, first the inverter will be turned off automatically after 1 minute time ( <a href="#">see Alarm 31</a> ). If one minute later the overtemperature is still detected, the UPS will be completely blocked (rectifier also shut-down) and the alarm appears.
61	Rectifier Overload. UPS Block.	When the rectifier is overloaded, depending on the level of this overload, the inverter will be shut down after some time according to the rectifier overload curve ( <a href="#">see Alarm 32</a> ). If this overload is still present with the inverter switched off, the UPS will be completely blocked (rectifier also shut-down) after seconds.
62	Inverter Desaturations. UPS Block.	When any inverter IGBT desaturates the number of times programmed by display (default: 200t) the inverter blocks. After two more attempts this alarm appears indicating UPS blocked.
63	DSP Internal Error. UPS Block.	After 3 attempts shutting down the UPS because of DSP Internal Error* in the UPS module.
64	PFC & Inverter Blockage. UPS Block.	There is a blocking condition for the inverter and also a blocking condition for the PFC.
65	Inverter Failure/Overload. Inverter Stop.	This alarm can be activated due to a connection of a load with high inrush current, or also, if it is detected a wrong transient voltage in the inverter (i.e., if there is a fault in an inverter transistor. The inverter will shut down for a while and load will be transferred to bypass immediately. The UPS will attempt to start up the inverter several times ( <a href="#">see Alarm 66</a> ).
66	Inverter Failure. Inverter Block	After several attempts detecting "Inverter Fault/Overload" ( <a href="#">see Alarm 65</a> ), the inverter will be blocked permanently, and output will be transferred to bypass.
67	Voltage Ramp Error. Inverter Stop.	During voltage ramp any fault is detected, the inverter will be shut down, and it will attempt to start it up several times ( <a href="#">see Alarm 48</a> ). (During Voltage ramping, rms value from sine wave voltage starts at 0Vrms until reaching its preset nominal value, i.e., 230Vrms).
68	DC BUS Voltage Wrong. Rectifier Stop.	High or low DC bus voltage is detected. Rectifier is shut down, in order to retry to start up later on ( <a href="#">see Alarm 41</a> ).
69	Parallel System Rectifier Stop.	<u>For parallel systems.</u> Rectifiers from the UPS of the system connected in parallel can be shut down, due to the management of system as a whole.
70	Parallel System Inverter Stop.	<u>For parallel systems.</u> Inverters of the UPS of the system connected at the output can be shut down, due to the management of system as a whole.
71	Pfc., Inv. Stop UPS Stop.	Combined shutdown of the PFC-rectifier and inverter has been done at the same time.
72	Parallel System UPS Stop.	<u>For parallel systems</u> UPS of the system connected at the output can be shut down (complete shutdown of the rectifier and inverter), due to the management of system as a whole.
73	Error Coms. Paral. Master Fixed.	<u>For parallel systems</u> One UPS (or more) that detect(s) communication errors, due to several reasons (parallel communication cables are disconnected, wrong connected, in bad status, wrong configuration of any of the units; etc.). Therefore, one UPS is set as a fixed Master of the system, and the rest of the units can only be slaves permanently (or till UPS is shut down and they will be started up again to test).
74	Alarm Paral. Sist. Redundancy Lost.	<u>For parallel systems</u> With N+M configuration, where: N: # units to size the system according to the maximum permissible load. M: # redundant units in the system. The alarm is displayed when the load exceeds the maximum permissible load by N units. In this condition, the UPS are not overloaded individually; meanwhile the load doesn't exceed the maximum load of N+M units.

<b>Alarm #</b>	<b>Alarm Name</b>	<b>Definition</b>
75	Cont. Test Fail Rectifier Stop.	Input contactor from the UPS faults. The DC bus voltage is not kept at certain level when closing input contactor. ( <a href="#">see Alarm 47</a> ).
76	Paral. Coms Error UPS Block.	<u>For parallel systems</u> After the first error in the parallel system communication, when one UPS has already been chosen as a Fix Master in the system, a second error or break in the communications has been detected by the Slave unit(s) Unit will be blocked permanently (Rectifier and Inverter are shutdown, output voltage is not supplied to the output of the system).
77	EEPROM Failure.	Error in configuration memory

(\*) DSP Internal Error can happen for the following reasons:

- Watch Dog failure.
- Wrong ADC measures.
- Communication errors between DSP and processor.