

Uninterruptible Power Supply

10 to 40 kVA Three-Phase
9 to 36 KW Three-Phase (UL924)



FIRSTLINE PL UPS
USER MANUAL



No reproduction of any part of this manual, even partial, is permitted without the authorization of Staco Energy Products Company. The Staco Energy Products Company reserves the right to modify the product described herein, in order to improve it, at any time and without notice.

301 Gaddis Boulevard • Dayton, Ohio 45403
U.S. Toll Free 866-261-1191
(937) 253-1191 • Fax: (937) 253-1723
Web site: www.stacoenergy.com

Thank you for choosing our product.

Staco Energy is highly specialized in the development and production of uninterruptible power systems (UPS). The UPS's of this series are high quality products, carefully designed and manufactured to ensure optimum performance.

Applicability

This manual applies to the following models:

FLP-010-x / FLP-924-9

10 kVA / 9 KW, 208 V input, 208 V output, 60 Hz.

FLP-015-x / FLP-924-13

15 kVA / 13 KW, 208 V input, 208 V output, 60 Hz.

FLP-020-x / FLP-924-18

20 kVA / 18 KW, 208 V input, 208 V output, 60 Hz.

FLP-030-x / FLP-924-27

30 kVA / 27 KW, 208 V input, 208 V output, 60 Hz.

FLP-040-x / FLP-924-36

40 kVA / 36 KW, 208 V input, 208 V output, 60 Hz.

Safety Warnings



IMPORTANT SAFETY INSTRUCTIONS SAVE THESE INSTRUCTIONS

This manual contains important instructions for Models 10, 15, 20, 30 and 40kVA FIRSTLINE PL series UPS that should be followed during installation and maintenance of the UPS. Please read all instructions before operating the UPS and save this manual for future reference.

READ AND FOLLOW ALL SAFETY INSTRUCTIONS

- a. Do not use outdoors.
- b. Do not route wiring across or near hot surfaces.
- c. Do not install near gas or electric heaters.
- d. Use caution when servicing batteries. Battery acid can cause burns to skin and eyes. If acid is spilled on skin or in eyes, flush acid with fresh water and contact a physician immediately.
- e. Unit should be installed where it will not readily be subjected to tampering by unauthorized personnel.
- f. The use of accessory equipment not recommended by the manufacturer may cause an unsafe condition.
- g. Do not use this UPS for other than intended use.

DANGER



This UPS contains LETHAL VOLTAGES. All repairs and service should be performed by AUTHORIZED SERVICE PERSONNEL ONLY. There are NO USER SERVICEABLE PARTS inside the UPS.

WARNING



To reduce the risk of fire or electric shock, install this UPS in a temperature and humidity controlled, indoor environment, free of conductive contaminants. Do not operate near water or excessive humidity (95% maximum).

WARNING



Input and output over-current protection and disconnect switches must be provided by others.

High ground leakage current may be present. Do not operate the unit without a proper protective ground.

WARNING



Batteries can present a risk of electrical shock or burn from high short circuit current. Observe proper precautions. Servicing should be performed by qualified service personnel knowledgeable of batteries and required precautions. Keep unauthorized personnel away from batteries.

There is a risk of explosion if batteries are replaced by an incorrect type. Replace with same type and rating only.

Proper disposal of batteries is required. Refer to your local codes for disposal requirements.

Never dispose of batteries in a fire

This product is available with internal batteries installed. When storing this product for more than 30 days it is recommended that the internal battery be disconnected. See [Section 2.2.2](#) and [Section 5.2](#) for instructions to disconnect the internal battery, and more details on long term battery storage.

Emergency Interventions

The following information is of a general nature.

First aid interventions



Company regulations and traditional procedures should be followed for any first aid intervention that may be required.

Fire fighting measures

1. Do not use water to put out a fire, but only fire extinguishers that are suitable for use with electrical and electronic equipment.
2. If exposed to heat or fire, some products may release toxic fumes into the atmosphere. Always use a respirator when extinguishing a fire.

Symbols used in the Manual





In this manual, some operations are shown by graphic symbols to alert the reader to the dangerous nature of the operations:

	Danger / Risk of Electric Shock <i>This symbol indicates possibility of serious injury or substantial damage to the unit, unless adequate precautions are taken.</i>
	Warning <i>This symbol indicates important information which must be understood and any stated precautions taken</i>
	Note

Protective Equipment

No maintenance operations shall be carried out on the unit without wearing the Personal Protective Equipment (PPE) described below. Personnel involved in the installation or maintenance of the unit must be properly clothed.

The following signs show the protective equipment that should be worn. The various items of PPE must be selected and sized according to the nature of the hazard (particularly electrical) posed by the unit.

	Accident prevention footwear		Protective eyewear
	Protective clothing		Helmet
	Work gloves		

GENERAL PRECAUTIONS

This manual contains detailed instructions for the use, installation and start-up of the UPS. Read the manual carefully before installation. For information on using the UPS, the manual should be kept close at hand and consulted before carrying out any operation on the UPS.

This UPS has been designed and manufactured in accordance with the standards for the product, for normal use and for all uses that may reasonably be expected. It may under no circumstances be used for any purposes other than those envisaged, or in any other ways than those described in this manual. Any interventions should be carried out in accordance with the criteria and the time-frames described in this manual.

Table of Contents

Applicability.....	ii
Safety Warnings	ii
Emergency Interventions	iv
First aid interventions	iv
Fire fighting measures	iv
Symbols used in the Manual	iv
Protective Equipment.....	v
GENERAL PRECAUTIONS	v
1. Layout.....	1
1.1 Views.....	1
1.2 Legends	4
2. Installation.....	5
2.1 Important Safety Instructions	5
2.1.1 Battery Safety Instructions	6
2.2 Equipment Handling	6
2.2.1 Unpacking and Content Checking.....	6
2.2.2 Storage	7
2.2.3 Transport	7
2.2.4 Location	7
2.3 Power Connections	8
2.3.1 Preparing UPS.....	8
2.3.2 Connection to Mains Input	9
2.3.3 Connection to the Bypass Input:	9
2.3.4 Connection to the Output	10
2.3.5 External Battery Connection	12
2.3.6 Connection Main Protective Earth.....	13
2.4 Control Connections	14
2.4.1 Com Port to Relay (X32).....	14
2.4.2 COM port RS-232 & RS-485. Connector (X31).....	14
2.4.3. EPO terminals (X50)	15
2.4.4 Parallel BUS Connection (X36i) and (X36o).....	16
2.4.5 External Control Terminals (X18)	17
3. Operation	18
3.1 Start up.....	18
3.1.1 Before Start Up	18
3.1.2 Start-Up Procedure Single Module.....	18
3.1.3 Start-Up Procedure Paralleled Modules	19
3.2 Shutdown	22
3.2.1 Inverter Disconnect	22
3.2.2 Complete Shutdown of UPS	22
3.2.3 Emergency Power Off (EPO)	23
3.3 Maintenance Bypass Transfer	23
3.3.1 Transfer to Manual Bypass	23
3.3.2 Transfer to Normal Operation.....	23
3.3.3 Emergency Transfer to Bypass	24
4. Control Panel and Display.....	25
4.1 Basic Functions of Keyboard	25
4.2 Screen Description	25
4.2.1 Main Screen.....	26

4.2.2 Control (CNTL) Menu.....	26
4.2.3 Measure (MEAS) Menu.....	27
4.2.4 Setting (SET) Menu	29
4.2.3 ALARM	30
5. Maintenance	31
5.1 Basic Maintenance Guide	31
5.1.1 Periodic maintenance (to be carried out by trained personnel and with doors closed).....	31
5.1.2 Maintenance inside the UPS (factory authorized personnel only).....	31
5.1.3 Ordinary maintenance for batteries (trained personnel only)	31
5.2 Internal Battery Replacement	32
5.3 Recommended Replacement Intervals	33
6. Specifications.....	34
6.1 Technical Specifications	34
6.2 Battery Runtime.....	35
6.3 Rated Currents and Field Wiring Information	35
Appendix A – Alarms	36

Figures

Figure 1 - 10-20kVA cabinet front view	1
Figure 2 - 30-40kVA Cabinet front view.....	1
Figure 3 - Control panel view.	1
Figure 4 - Communication connector details with front door open.....	1
Figure 5 - Cabinet front view for UPS 10-20kVA with lower inner protective panel removed.	2
Figure 6 - Cabinet front view for UPS 30-40kVA with lower inner protective panel removed.	3
Figure 7 - Recommended spacing around unit.....	8
Figure 8 - Single line diagram of parallel system connection.....	11
Figure 9 - Typical Connection between a UPS and two battery cabinets.....	13
Figure 10 - Terminals for connection of external push-button (EPO), supplied by the user	15
Figure 11 - Parallel Communication Connections.....	16
Figure 12 - Settings Screen	20
Figure 13 - Advanced Screen.....	20
Figure 14 - Service Screen	20
Figure 15 - Parameters Screen page 3	21
Figure 16 - Typical Main screen	25
Figure 17 - Typical Control Screen.....	26
Figure 18 - UPS ON/OFF Screens.....	27
Figure 19 - Manual Battery Test Screen.....	27
Figure 20 - Setting Menu.....	29
Figure 21 - Alarm Screen	30
Figure 22 - UPS Internal Battery trays.....	32

Tables

Table 1 - Alarms interface to relays connector DB9 (X32).....	14
Table 2 - Recommended Replacement Intervals	Error! Bookmark not defined.

1. Layout
1.1 Views

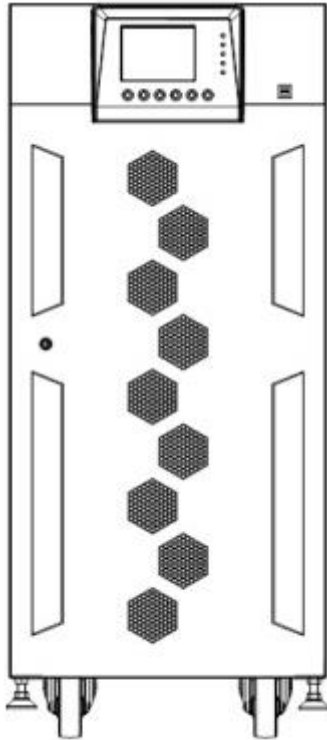

Figure 1 - 10-20kVA cabinet front view

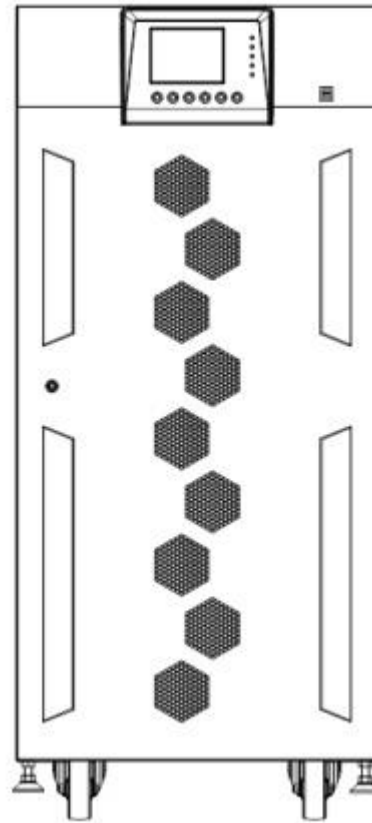

Figure 2 - 30-40kVA Cabinet front view

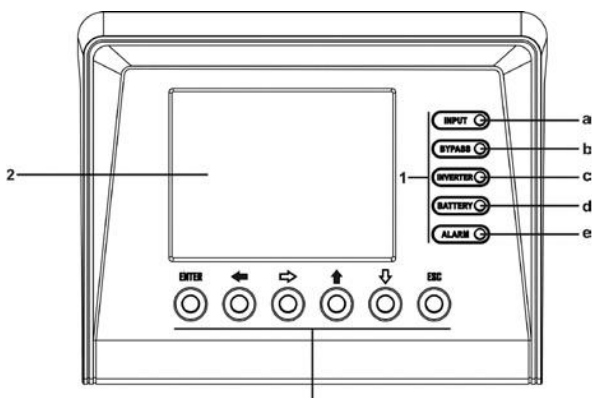

Figure 3 - Control panel view.

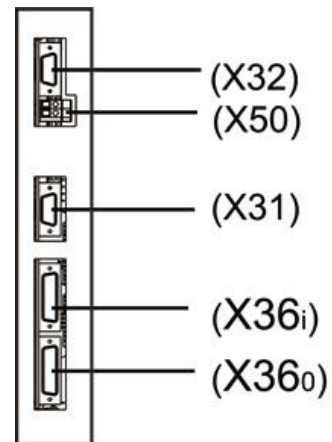

Figure 4 - Communication connector details with front door open.

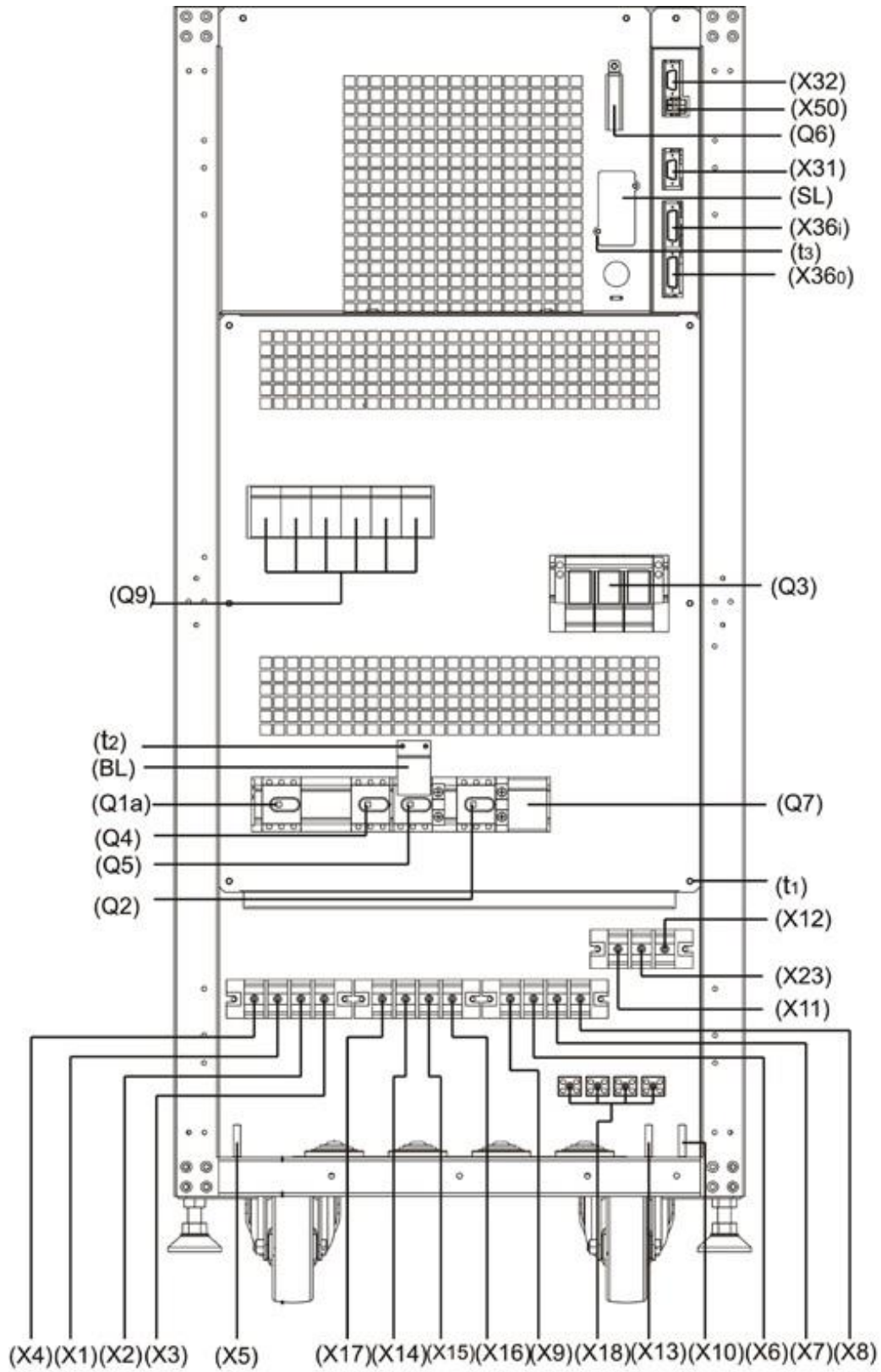

Figure 5 - Cabinet front view for UPS 10-20kVA with lower inner protective panel removed.

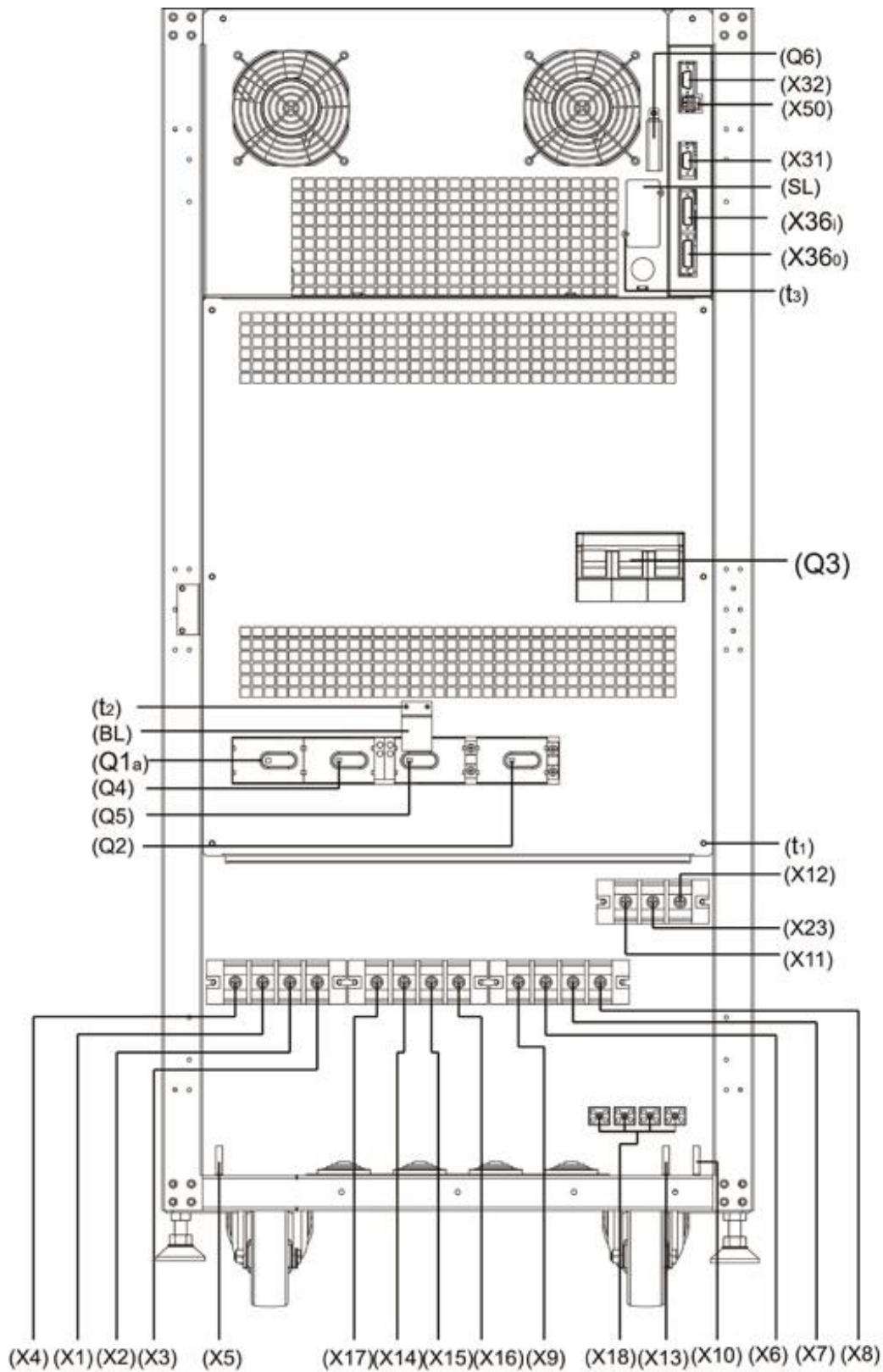

Figure 6 - Cabinet front view for UPS 30-40kVA with lower inner protective panel removed.

1.2 Legends

Protection Elements:

- (Q1a) Input Circuit Breaker or Switch.
- (Q2) Output Switch.
- (Q3) Main Battery Disconnect.
- (Q4) Static Bypass Switch.
- (Q5) Manual Bypass Switch.
- (Q6) Emergency Bypass Switch.
- (Q7) External Battery Disconnect
(10-20kVA only)
- (Q9) Input Fuses.

Power Connections:

- (X1) Phase A input terminal.
- (X2) Phase B input terminal.
- (X3) Phase C input terminal.
- (X4) Input Neutral (N) terminal.
- (X5) Main Earth Ground Terminal.

- (X6) Phase A output terminal.
- (X7) Phase B output terminal.
- (X8) Phase C output terminal.
- (X9) Output Neutral (N) terminal.
- (X10) Ground Terminal for loads and
battery cabinet(s).

- (X11) Positive (+) Battery terminal.
- (X12) Negative (-) Battery terminal.
- (X23) Batteries terminal N.

- (X14) Phase A Static Bypass terminal.
- (X15) Phase B Static Bypass terminal
- (X16) Phase C Static Bypass terminal
- (X17) Static Bypass Neutral (N) terminal.

Control Connections:

- (X18) External Control Terminals:
 - Remote EPO,
 - Remote Inverter Shutdown,
 - Remote External Battery Bank Shutdown
 - Battery Temperature detection NTC.
- (X31) RS-232 and RS-485 COM DB9 connector.
- (X32) Relay Interface DB9 connector.
- (X36i) Parallel BUS input, Female connector HDB15.
- (X36o) Parallel BUS output, Male connector HDB15.
- (X50) Local EPO.

Keyboard and LCD control panel (PC):

- (1) LED Indicators
 - a. Rectifier Input Voltage OK (green).
 - b. Output voltage unit from the Bypass (orange).
 - c. Inverter is working (green).
 - d. Unit working from batteries -mains failure (red).
 - e. General alarm (red).
- (2) LCD Touch Screen.
- (3) Buttons
 - (ENTER)** Enter Key.
 - (ESC)** Escape Key.
 - (↑) Move up.
 - (↓) Move down.
 - (→) Move right.
 - (←) Move left.

Other abbreviations:

- (BL) Mechanical block for manual bypass switch (Q5).
- (SL) SNMP card.
- (t1) Screws for terminals cover (TB).
- (t2) Screws for mechanical block (BL) for switch (Q5).
- (t3) Screws fixing for slot cover (TS).

2. Installation

- Check the Safety Instructions.
- Any incorrect connection or handling may cause damage to the UPS and/or the loads connected to it. Read these instructions carefully and follow the steps indicated.
- This UPS must be installed by qualified electrician.
- It is advisable to provide a maintenance bypass switch or an electrical panel with individual protection for input, output, and static bypass, as well as a manual bypass. This allows isolation of unit during preventive maintenance or repair.

Upon request, a maintenance bypass switch can be sized to your specific requirements.

2.1 Important Safety Instructions

WARNING



As this is a unit with class I protection against electric shocks, it is essential to install an earth conductor. Connect the ground conductor to the terminal **(X5)**, before connecting the power supply to the UPS input.

Before installing any cables, power or control, verify that all UPS switches are in open position and no power is available to the UPS.

The UPS has multiple electrical inputs and produces electrical output. Verify all terminals are at zero-voltage state before any work on the UPS is performed.

Warning labels should be placed on all primary power switches installed remotely from unit to alert the electrical maintenance personnel of the presence of a UPS in the circuit. The label should bear the following or an equivalent text:

Before working on this circuit.
- Isolate Uninterruptible Power System (UPS).
- Check for Hazardous Voltage.
 **Risk of Voltage Backfeed**

WARNING



Once the mains power supply is powered up to the input of the UPS, there may be voltage at the output terminals. To have no voltage on the output terminals, switches **(Q1a)**, **(Q4)** and **(Q2)** must be in Off position.

The output terminals may have output voltage from the manual bypass. If the output power supply of the UPS has to be interrupted, open switch **(Q5)**.

Precautions must be taken working around the batteries. Batteries are not isolated from the AC input, and dangerous voltage between the battery terminals and the ground may be present.

2.1.1 Battery Safety Instructions

WARNING



The handling and connection of the batteries shall be done and supervised by personnel with battery knowledge.

If an installed a -0 version UPS (no internal battery) and want to install batteries, consult with factory service before attempting to install batteries.

Only a qualified technician should attempt to install or replace batteries in this equipment. [See Section 5.2](#) in this manual for detailed instructions.

The battery supply can involve the risk of electric shock and can produce high short circuit current. Observe the following preventive measures before working with Battery Terminals:

- Disconnect the corresponding protection elements.
- When connecting a battery cabinet to the UPS, verify correct polarity.
- Wear rubber gloves and shoes.
- Use tools with insulated handles.
- Removes watches, rings or other metal objects.
- Do not place metal tools or objects on the batteries.
- Never short the battery terminals as it will result in a high safety risk and potential damage to the battery and the UPS.
- Avoid mechanical impacts.
- Do not open or mutilate the battery. Released electrolyte is harmful to the skin and eyes.
- Do not dispose of batteries in a fire. The batteries may explode.
- In case of contact of the acid with parts of the body, wash immediately with plenty water and seek medical help.
- Batteries involve a serious risk for health and for the environment. Their disposal should be done according to the existing laws.

2.2 Equipment Handling

2.2.1 Unpacking and Content Checking

Upon receiving the UPS, make sure that it has not suffered any damage in transport. If any shipping damage is noticed, make all pertinent claims to the carrier. Also check that the data in the nameplate, which is attached inside the front door, corresponds to those specified in the purchase order; it will be necessary to unpack it. To unpack, cut the bands on the cardboard container and remove it by lifting above or remove it with the necessary tools if made of wood; remove the corner pieces and the plastic sleeve. The UPS should be unpacked on the pallet.

When the unit has been accepted, it is best to repack the UPS until it is put into service in order to protect it from any possible mechanical damage, dust, dirt, etc....

2.2.2 Storage

Storage of the UPS should be in a dry, ventilated place and protected against rain, water or chemical agents. It is advisable to maintain the UPS in the original package which has been designed to assure the maximum protection during transport and storage.



The UPS may have installed batteries and should not be stored for more than 12 months at 25 degrees C or 3 months at 40 degrees C. Extended storage at elevated temperatures will cause irreversible damage to the battery.

When a long storage time is required, the batteries can be maintained:

- 1 Unpack UPS
- 2 Connect the UPS to an Input Utility.
- 3 Start up UPS according to the instructions described in this manual and charge the batteries for 24 hours.
- 4 Then shut down the UPS, disconnect it and keep the UPS in their original packaging until the next charge is required.



Do not store the unit where the ambient temperature exceeds 40° C or falls below -20° C, as this may degrade the electrical characteristics of the batteries.

2.2.3 Transport

All UPS have castors to facilitate transport to their final location. It is important to observe the rough weights indicated in the technical specs both with respect to the site itself and the means to be used to put it there (floor, hoist, lift, stairs, etc...).

2.2.4 Location



The UPS requires a minimum of 8 inches clearance in the back. Clearance above the UPS must be 18 inches minimum. Failure to adhere these minimum clearances will result in overheating.

Adequate space must be provided on the sides and front for service and maintenance ([See Figure 7](#)). In parallel systems or systems with external battery or other cabinets there is no requirement to separate the cabinets other than maintaining the ability to service the UPS from the sides and assuring the paralleling cables can connect to each unit. Using flexible conduit for power wiring may provide some benefit.

Two levelers located close to the front casters are used to level and straighten the UPS once it is placed. Open the front door of the cabinet and loosen the leveling by turning them counter clockwise until they touch the floor, and then using a tool, continue turning until the castors are raised off the floor by a maximum 0.2 in, ensuring that UPS is level. Close the door.

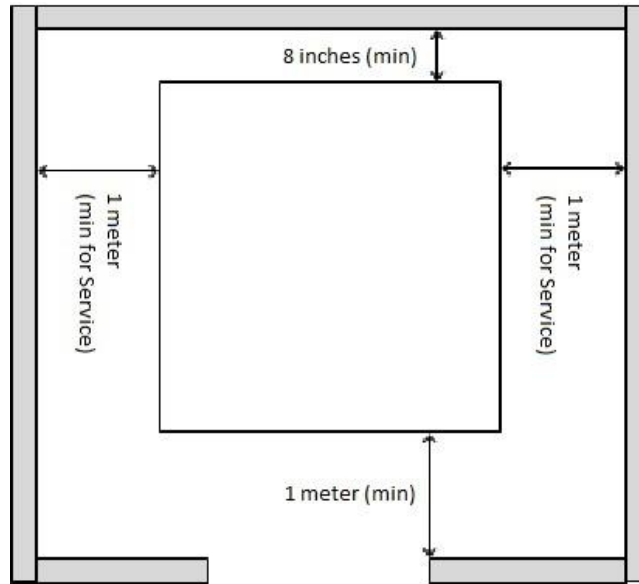

Figure 7 - Recommended spacing around unit

2.3 Power Connections

2.3.1 Preparing UPS

All of the UPS models have terminals for power connection and DB9 connectors for communications located inside the UPS front door. Follow the steps described below for access to all connections:

- Unlock the front door lock with the provided key.
- DB9 connectors for communication ports are located at the top right side of the inner panel.
- Terminals for remote EPO and other functions are located at the bottom front.
- Remove the screws (t1) securing the terminal cover inside of the cabinet and set it aside. The input, output and external battery terminals are now exposed.
- Once the connection of the UPS is finished, replace the cover and close the door.



Wire size should be in accordance with NEC and local code using the currents shown in [Section 6.3](#).



In parallel systems, the length and cable cross section from the distribution panel to each UPS and from each UPS to the load panel will be the same for all without any exception. This is required to maintain load balance between parallel units.

Circuit protection in power distribution panels should have following characteristics:

- For input and bypass, type B earth leakage breakers and circuit breakers curve C.
- For the output, circuit breaker curve C.
- Their size will be compatible, as minimum, with the currents stated in [Section 6.3](#).

If input, output or bypass peripherals were added to the UPS, like transformers or autotransformers, follow the installation instructions in the manuals for those units.

The UPS is equipped with fuses located between the external battery connection (**X11, X12, X23**) and the internal battery. These fuses are located in a disconnect **Q7 (10Kva ~ 20Kva)** or 2 larger panel mount fuses located below **Q3 (30/40Kva)**.

 All models have 3 fuses located in a fuse holder/disconnect **Q3**.

These fuses isolate the battery from the inverter and must be installed into Q3 and closed before the UPS will be fully operational.

Danger



It is critical that the disconnect Q3 is not closed with the fuses installed until instructed to do so by the front panel LCD during the start-up sequence. Failure to comply may result in damage to the UPS.

2.3.2 Connection to Mains Input



Connection to the ground:

This unit is class I protection against electric shocks, a ground conductor must be installed. Connect the conductor from to the terminal (**X5**), before connecting the power to the UPS input. [See Section 6.3](#) for current ratings.

Connection to the Input:

Connect the power supply cables N-A-B-C to the input terminals (**X4**), (**X1**), (**X2**) and (**X3**), **following the order of neutral and phases** indicated on the label of the unit and in this manual.

See Section 6.3 for current ratings



If the order of the phases is not followed, the unit will not operate. When there are discrepancies between the labeling and the instructions of this manual, the label on the UPS will always prevail.

2.3.3 Connection to the Bypass Input:

Single Input

By default, there are jumper wires between terminal X1-X4 and X14~X17. This means the bypass shares the same source with line input.

Independent Bypass Input

The UPS can have a bypass input that is separate from the rectifier input by removing jumper wires between terminal X1-X4 and X14~X17.



Connection to the ground:

This unit is class I protection against electric shocks, a ground conductor must be installed. Connect the conductor from to the terminal (**X5**), before connecting the power to the UPS input. [See Section 6.3](#) for current ratings.

Connection to the Bypass:

Connect the bypass power supply cables N-A-B-C to the static bypass line terminals **(X17)**, **(X14)**, **(X15)** and **(X16)**, **following the order of neutral and phases** indicated on the label of the unit and in this manual.



If the order of the phases is not followed, the unit will not operate. When there are discrepancies between the labeling and the instructions of this manual, the label on the UPS will always prevail.

WARNING



In units with a separate bypass line, an isolation transformer must be placed at any of both input power supply mains of the UPS (rectifier input or bypass), in order to avoid the direct connection of the neutral of both mains through the internal wiring of the UPS. The only case for which the isolation transformer is not required is when the rectifier input and the bypass input come from the same separately derived source. That is, both inputs come from sources that share a common neutral to ground bond.

When UPS is connected to independent bypass source the setting for bypass type needs to change to: **Independent** in advance Parameter menu. See [Section 4.2.4.2](#) for Parameter menu access.

2.3.4 Connection to the Output



Connection to the ground:

This unit is class I protection against electric shocks, a ground conductor must be installed. Connect the conductor from to the terminal **(X5)**, before connecting the power to the UPS input. [See Section 6.3](#) for current ratings.

Single Module

Connect the loads cables N-A-B-C to the output terminals **(X9)**, **(X6)**, **(X7)** and **(X8)**, **following the order of neutral and phases** indicated on the label of the unit and in this manual.



If the order of the phases is not followed, the unit will not operate. When there are discrepancies between the labeling and the instructions of this manual, the label on the UPS will always prevail.

Paralleled Modules

From each module in system, connect the loads cables N-A-B-C to the output terminals **(X9)**, **(X6)**, **(X7)** and **(X8)**, **following the order of neutral and phases** indicated on the label of the unit and in this manual.



If the order of the phases is not followed, the unit will not operate. When there are discrepancies between the labeling and the instructions of this manual, the label on the UPS will always prevail.

With respect to the protection that must be placed on the output of the UPS, it is recommended that the output power should be distributed in at least four lines. Each will have a magnetic thermal protection switch of a value of one quarter of the nominal power. This type of power distribution will mean that in the event of a fault, the fault will be isolated. The rest of the connected loads will have their continuity

assured due to the triggering of the protection, only the line affected by the fault will remain. [See Figure 8](#) for diagram.

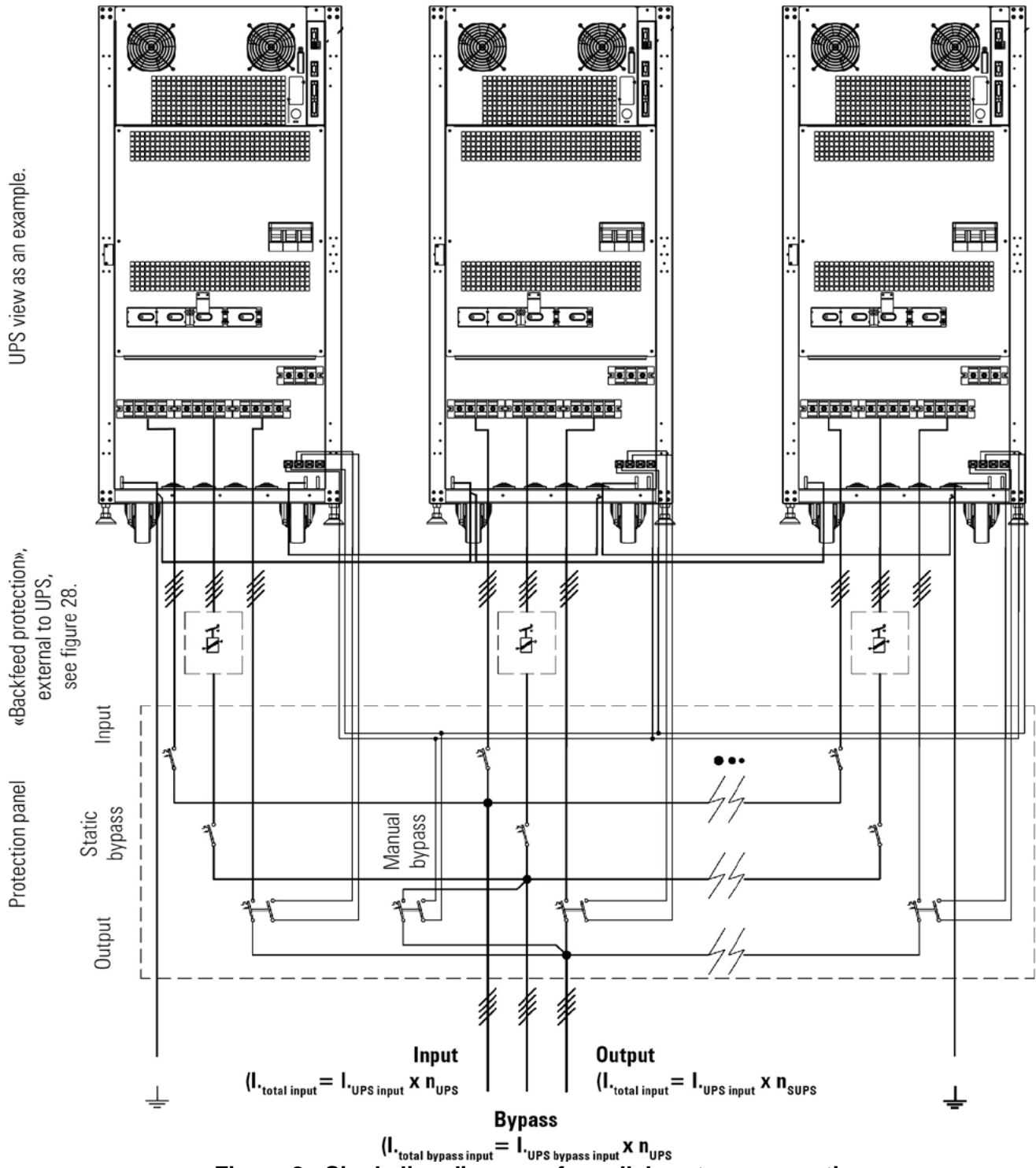

Figure 8 - Single line diagram of parallel system connection

2.3.5 External Battery Connection

Danger



On units with internal batteries, there will be a high level DC voltage across these terminal connections. Use extreme caution when connecting the external batteries. Only use properly insulated tools. Failure to comply may cause irreversible damage to the UPS or personal harm.



Connection to the ground:

This unit is class I protection against electric shocks, an ground conductor must be installed. Connect the conductor from to the terminal **(X5)**, before connecting the power to the UPS input.

Danger



IMPORTANT FOR SAFETY: Do not close the battery fuse holder **(Q3)** located in the UPS until instructed to do so in the startup procedure. Failure to comply may cause irreversible damage to the UPS or personal harm because the operator is exposed to ELECTRICAL DISCHARGE DANGERS when connecting the UPS battery.

UPS connection with an external battery will be made by connecting properly sized cables to terminals **(X11)**, **(X23)** and **(X12)**, matching polarity at the external battery terminals.



Insure that the external battery complies with the battery requirements for this UPS system. See the external battery documentation for connection details.

If more than one external battery cabinet is to be connected, the connection will always be in parallel among them and the UPS's cable from the negative of the UPS to the negative of the first battery pack and from this one to the negative of the second battery pack, and so on. Proceed in the same way for positive cables, half tap (N) and earth. ([See Figure 9](#))



When connecting external battery cabinets to multiple UPS in a parallel configuration, each UPS must have its own separate battery cabinet(s). A single battery cabinet cannot be shared between multiple UPS.

Danger



If after starting up the UPS, it is required to disconnect the battery cabinet, the UPS has to be completely shut down (see shut down section). Turn off the battery cabinet circuit breaker and/or fuse holder disconnect **(Q3)** located in the UPS. Wait at least 5 min. until the filter capacitors have been discharged.

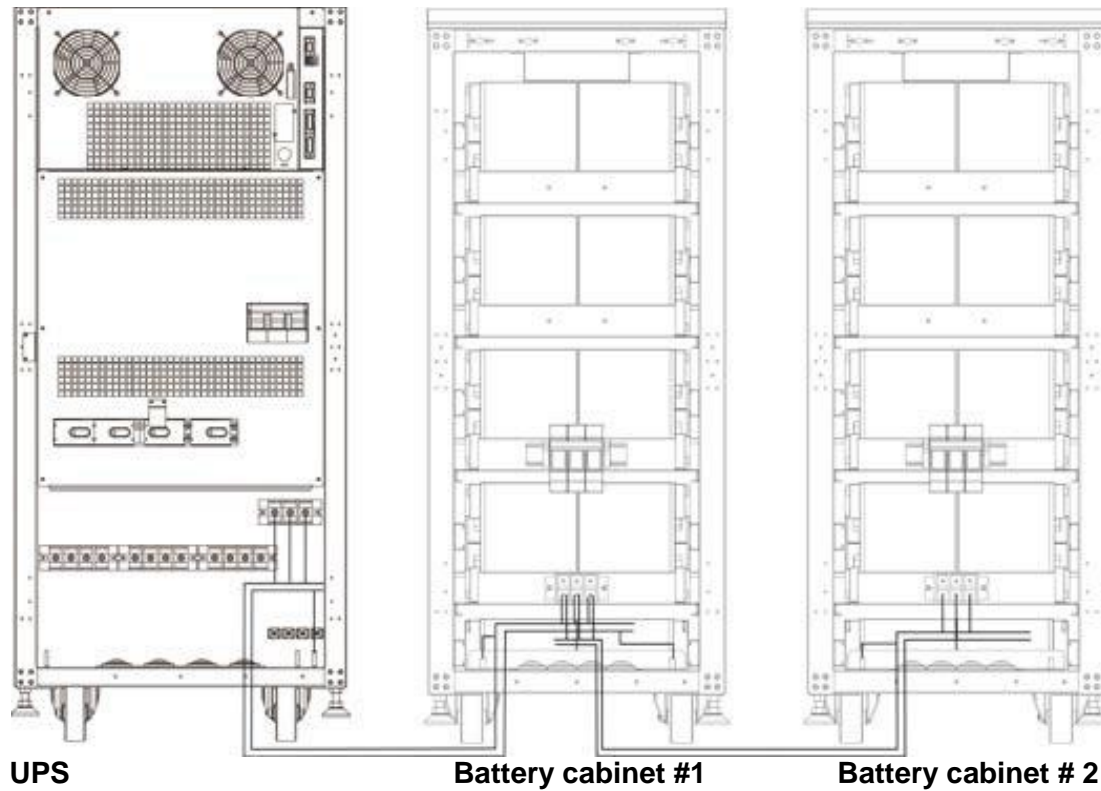

Figure 9 - Typical Connection between a UPS and two battery cabinets.

2.3.6 Connection Main Protective Earth

Make sure that all loads connected to the UPS are only connected to the ground bonding terminal. Grounding of the load(s) and/or the battery case(s) or cabinet(s) to this **single point** will help prevent ground loops which will affect the quality of the power supplied.

All of the terminals identified as ground, are joined together, to the main grounding terminal and to the frame of the unit.

2.4 Control Connections

2.4.1 Com Port to Relay (X32)



The communications line (COM) constitutes a very low safety voltage circuit. To preserve the quality, it must be installed separately from other lines that have dangerous voltages (power distribution line).

The communication port to relays provides digital signals in the form of potential free form A contacts with a maximum applicable voltage and current of 6 A, 30 V DC or 6 A, 100 V AC. Both X31 and X32 (see 2.4.2) connections can be used for connecting the UPS with any machine or units that has standard bus (connector DB9 (X32)). See [Figure 4](#).

Standard units consist of 5 output signaling relays (one of which is configurable), with common point is connected to pin 5. Also an input signal can be externally supplied to perform Shutdown (5V~12V).

Pin-out No.	Description	N.C. - N.O. Position
1	Shutdown signal +	-
2	Shutdown signal –	-
3	Reserved	
4	Reserved	
5	Common	-
6	Equipment in Bypass	N.O.
7	Low battery	N.O.
8	General alarm	N.O.
9	Reserved	

N.C.: Normally closed contact. When alarm is activated the contact is opened.
N.O.: Normally open contact. When alarm is activated the contact is closed.

Table 1 - Alarms interface to relays connector DB9 (X32).

2.4.2 COM port RS-232 & RS-485. Connector (X31).



The communications line (COM) constitutes a very low safety voltage circuit. To preserve the quality, it must be installed separately from other lines that have dangerous voltages (power distribution line).

In the connector DB9 there are ports of communication of the UPS to the RS-232 and the RS-485. It is not possible to use them simultaneously as both are mutually exclusive.

Both X31 and X32 (see 2.4.2) connections can be used for connecting the UPS with any machine or units that has standard bus (connector DB9 (X32)). See [Figure 4](#).

2.4.2.1 RS-232

Physical structure of the RS-232

Pin-out

- Pin 2. RXD. Serial data reception.
- Pin 3. TXD. Serial data transmission.
- Pin 5. GND. Signal mass.

Communication protocol of the RS-232

The communication protocol used is of «MASTER/SLAVE» type. The computer or computer system («MASTER») asks about a certain data, and the UPS («SLAVE») answers immediately with the required data. First the communication channel of the computer will be programmed with the same parameters as the communication channel of the UPS.

- Communication speed: 1200, 2400, 4800, 9600 or 19200 Bauds.
- No. information bits: 8 Bits.
- No. stop bits: 1 or 2 stop bits.
- Parity: - Even, Odd or None.

2.4.2.2 RS-485

Physical structure of the RS-485

The unit uses only 2 wires (pins 4 and 9 of the female DB9 connector) to perform the dialogue between the systems connected to the network. The communication will be established by sending and receiving signals in a differential mode, which gives the system great immunity to noise over a long distance (approx. 800 m).

Pin-out

- Pin 4. Output signal A (+) of the RS-485.
- Pin 9. Output signal B (-) of the RS-485.

Communication protocol of the RS-485

The communication protocol of the RS-485 channel is developed to enable the UPS to communicate with other computer systems that utilize the same protocol.

- Communication speed: 1200, 2400, 4800, 9600 or 19200 Bauds.
- No. information bits: 8 Bits.
- No. stop bits: 1 or 2 stop bits.
- Parity: - Even, Odd or None.

2.4.3. EPO terminals (X50)

The EPO switch must be normally closed and latch open when pressed in order to open the circuit (X50) to activate the emergency shutdown.

To restore the UPS to normal mode, return the position of the switch or button (EPO), close the circuit (X50).

A local EPO button is mounted on the front panel next to the LCD. After an EPO event using this button it must be depressed again to clear the EPO before the UPS can be restarted.

For operating instructions for the (EPO), see [Section 3.2.3](#) of this manual.



In a parallel system only one remote EPO is required to control all of the units in the system.

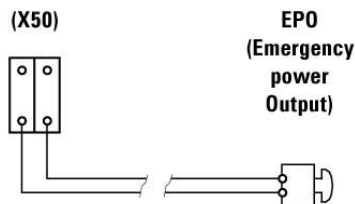

Figure 10 - Terminals for connection of external push-button (EPO), supplied by the user

2.4.4 Parallel BUS Connection (X36i) and (X36o)



This section is only used for parallel systems. Up to four UPS of the same model can be paralleled.

In order to allow correct operation of all functions, each UPS in a parallel system will communicate with the others through a set of cables forming a communications loop.

Once the power connections of the UPS from parallel systems are made, it is required that the parallel communication cables (supplied) be connected. Each UPS is supplied with a pair of 5 meter cables with HDB15 connectors at their ends, one male and the other one female.

Warning



ANY MODIFICATION TO THE COMMUNICATION BUS CABLES OR CONNECTORS WILL RESULT IN UPS FAILURE.

Begin with the first unit and connect one end of the supplied communications cable to the appropriate mating connector (X36o) on the UPS. Connect the other end of that same cable to (X36i) on the next UPS. Continue in this manner by finishing with the final cable connection from the last UPS in the system back to the first. A communications loop has now been formed between all of the units in the system.

[See Figure 11.](#)

The bottom of front door has a cutout to allow passage of the cables in case the installer does not want to run them through conduit. Take care to not trap cables between the door ends and the cabinet when closing.

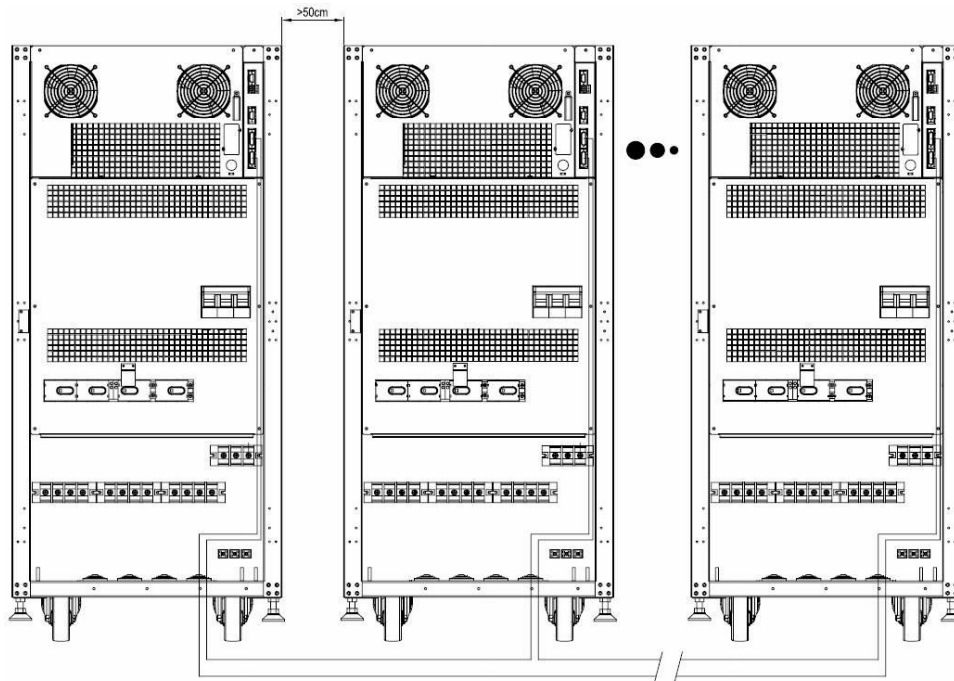

Figure 11 - Parallel Communication Connections

2.4.5 External Control Terminals (X18)

- Remote EPO,
- Remote Inverter Shutdown,
- Remote External Battery Bank Shutdown
- Battery Temperature detection NTC.

Remove the screws from the protective panel covering the terminals. Set the panel aside and feed the wires through from the bottom. After connecting, replace protective panel.

3. Operation



It is critical that the following procedure be followed in the sequence given.

3.1 Start up

3.1.1 Before Start Up

Verify that all the connections have been made correctly and are sufficiently tight, following the labeling of the phase rotation sequence.

Check that the UPS switches and any external battery cabinet or cabinets are in off position.

Be sure that all the loads are turned off.

3.1.2 Start-Up Procedure Single Module



It is very important to follow the established order during the following instructions. **DO NOT** close Q2 until instructed to do so.

1. If the UPS is connected to an external battery cabinet(s), close battery cabinet breaker(s).
2. Close the mains circuit breaker to provide power to the input of the UPS.
3. Turn the input switch (**Q1a**) to “On” position. The display of the Control Panel will be turned on automatically. **DO NOT** close any other switches at this time.

If the following alarm message appears on the Control Panel Display, the UPS cannot be started because of incorrect input phase sequence.

! MAINS PHASE ROT. UPS START INH.

Disconnect the input switch (**Q1a**) and the mains power. Swap the phases of the input terminals of the UPS according to the labeling and repeat the start-up process.

4. Turn the Bypass switch (**Q4**) to “On” position.

Units with separate Bypass, if the following alarm message appears on the Control Panel Display, the UPS cannot be started because of incorrect input phase sequence.

! MAINS PHASE ROT. UPS START INH.

Disconnect the Bypass switch (**Q4**) and the mains power. Swap the phases of the input bypass terminals of the UPS according to the labeling and repeat the start-up process.

5. At this point, with no alarm active, green LED indications of Input Voltage OK, and orange LED indication of Unit on Bypass should light ((a), (b) from [Figure3](#)).



The startup operation will be done through the keypad of the control panel ((3) from [Figure 3](#)).

6. Start up the inverter through the keypad of the control panel.
 - a. Select “CNTL”,
 - b. Select “ON”.
 - c. Screen to start the unit up will appear, select 



Pressing  will cancel start-up

7. After 30 seconds, the inverter and rectifier will start.
8. Turn the output switch (Q2) to “On” position.
9. The system will supply voltage at the output terminals.
10. Make sure that the inverter LED (c) is turned on (green), and bypass LED (b) is turned off in all UPS’s (see [Figure 3](#)). If the led status is not the correct, contact Service and Technical Support.
11. Once the rectifier is completely started, the process of equalization (DC bus voltage starts to equalize with battery voltage) is started. After a few seconds (depending on the battery level), an alarm message will display that the equalizing process has been finished, and **AT THIS MOMENT ONLY** is when the battery fuse holder disconnect on the UPS (**Q3**) can be closed.

! BATT. SWITCH OPEN, SWITCH IT ON



DO NOT TRY to close Q3 battery fuse disconnect at any other time or there may be damage to the UPS.

12. The system is now started up completely, and the UPS is protecting the critical load.

3.1.3 Start-Up Procedure Paralleled Modules



It is very important to operate in the established order during the following instructions. The instructions assume that each unit in the system has all internal jumpers set correctly by factory authorized personnel.

1. If any UPS is connected to an external battery cabinet(s), close battery cabinet breaker(s).
2. Close the mains circuit breaker to provide power to the input of the each UPS in the system.
3. Turn the input switch (**Q1a**) to “On” position for each UPS in system. Each display of the Control Panel will be turned on automatically. Do not close any other switches at this time.

If the following alarm message appears on the Control Panel Display and also an audible alarm comes on, the UPS cannot be started because of incorrect input phase sequence.

! MAINS PHASE ROT. UPS START INH.

Disconnect the input switch (**Q1a**) and the mains power. Swap the phases of the input terminals of the UPS according to the labeling and repeat the start-up process.

4. Configure each UPS in System
 - a. Enter into the Settings screen as shown in [Figure 12](#).

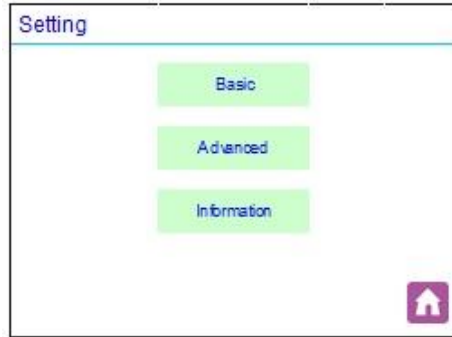

Figure 12 - Settings Screen

- b. Go into the Advanced screen as shown in [Figure 13](#). The password is 01899. (For more information on the Advanced Settings screen, see [section 4.2.4.2](#)).



Figure 13 - Advanced Screen

- c. The Service screen will now be visible, see [Figure 14](#). From this screen, touch the Parameters button.



Figure 14 - Service Screen

- d. In the Parameters section, go down to page 3. (See [Figure 15](#))
 - i. All UPS's should have a default address of 1 to start. Verify the first unit is set to 1, then go to each of the remaining units and set the address to 2, 3, or 4 depending on how many units are in the group.
 - ii. Set Parallel Unit to "Yes".

- iii. Set Parallel Total Number to the number of UPS units in system (maximum of 4).



Figure 15 - Parameters Screen page 3

5. Turn the Bypass switch (**Q4**) to “On” position for each UPS in the system.

Units with separate Bypass, if the following alarm message appears on the Control Panel Display and also an audible alarm comes on, the UPS cannot be started, because of incorrect input phase sequence.

! MAINS PHASE ROT. UPS START INH.

Disconnect the Bypass switch (**Q4**) and the mains power. Swap the phases of the input bypass terminals of the UPS according to the labeling and repeat the start-up process.

6. At this point, with no alarm active, green LED indications of Input Voltage OK, and orange LED indication of Units on Bypass should light ((a), (b) from [Figure 3](#)).



The startup operation will be done through the keypad of the control panel ((3) from [Figure 3](#)).

7. Turn the output switch (Q2) of each UPS in system to “On” position.
8. Start up the inverter through the keypad of the control panel.
 - a. Select “CNTL”,
 - b. Select “ON” and.
 - c. Screen to start the unit up will appear, select. 



Pressing  will cancel start-up

9. After 30 seconds, the inverter and rectifier will start.



The first UPS inverter to start will be set as “Paral. Mst. Byp” initially, the one with the highest address as “Paral. Slv. By.Rsv” and the rest, if there are any as “Paral. Slv. By”. In systems with just two UPS the “Paral. Slv. By” will not exist.

10. The system will supply voltage at the output terminals.

11. Make sure that the inverter LED (c) is turned on (green), and bypass LED (b) is turned off in all UPS's (see [Figure 3](#)). If the led status is not the correct, contact Service and Technical Support.
12. Once the rectifier is completely started, the process of equalization (DC bus voltage starts to equalize with battery voltage) is started. After a few seconds (depending on the battery level), an alarm message will display that the equalizing process has been finished, and **IN THIS MOMENT ONLY** is when the battery fuse holder disconnect on the UPS (**Q3**) can be closed.

! BATT. SWITCH OPEN, SWITCH IT ON



DO NOT TRY to close Q3 battery fuse disconnect at any other time or there may be damage to the UPS.

13. The system is now started up completely, and the UPS is protecting the critical load.



With the system running (switches turned “On”), if the inverter of any UPS is shut down or restarted the using the keypad of any UPS, all of parallel units will be turned “Off” or “On”. In both cases, the UPS still supplies output voltage at through the inverters (“On” position) or through the static bypass (“Off” position).

3.2 Shutdown

3.2.1 Inverter Disconnect

Turn the output switch (**Q2**) of the UPS to shut down “Off”. In the screen on LCD panel will display:

Not connected

3.2.2 Complete Shutdown of UPS

1. Shutdown the loads.
2. Open any distribution breakers.
3. Shutdown the inverter.
 - a. Through the keypad of the control panel ((**3**) from [Figure 3](#)), go down to “CNTL” submenu, and select “OFF”.
 - b. On next screen, “**ENT**” to shutdown inverter.
4. Turn the output switch (**Q2**) to “Off” position.
5. Set the input switch (**Q1a**) to “Off” position.
6. Open the circuit breaker on any external battery cabinet(s) and open the fuse disconnect in the UPS (**Q3**).
7. To completely isolate UPS, remove power to the UPS input and the bypass. The system is now completely deactivated.

Danger



After shutdown of the UPS, wait at least 5 minutes before performing any maintenance or service work to allow the electrolytic capacitors to be discharged.

3.2.3 Emergency Power Off (EPO)

Emergency Power Off (EPO) will completely shutdown unit or system of units:



When activated, the output voltage to the load is turned off.

3.2.3.1 Remote Emergency Power Off (REPO)

Remote shutdown function (REPO) is activated through the terminal strip (X50). A Normally Closed contact is opened, REPO will activate and completely shut down the module.

In a parallel system, it is only necessary to connect a Remote EPO to one UPS. The communication BUS will shut down all units when any single unit REPO is activated.

3.2.3.2 Local Emergency Power Off (EPO)

Local shutdown function (EPO) is activated from front panel mounted EPO button. When button is depressed, EPO will activate and completely shut down the module.

3.3 Maintenance Bypass Transfer

3.3.1 Transfer to Manual Bypass

Procedure for passing from normal operation to manual bypass:

1. Shutdown the inverter.
 - a. Through the keypad of the control panel ((3) from [Figure 3](#)), go down to “CNTL” submenu, and select “OFF”.
 - b. On next screen, “ENT” to shutdown inverter.
 - c. Load is now on Static Bypass
2. Remove the screws holding the metal bracket blocking operation of the switch (**BL** – See [Figure 5](#) & [Figure 6](#)) and remove the metal bracket
3. Turn manual bypass switch (**Q5**) to “On” position.
4. Set the output switch (**Q2**) to “Off” position.
5. Set the Battery Fuse disconnect (**Q3**) to “Off”.
6. Open the circuit breaker on any external battery cabinet(s).
7. Turn input switch (**Q1a**) to “Off” position.



The UPS is supplying output voltage directly from the utility source through the manual bypass.

8. The UPS is completely shut down.

3.3.2 Transfer to Normal Operation

Procedure for switching from manual bypass to normal operation:

1. When an external battery cabinet is connected, close the battery breaker(s).
2. Set the input switch (**Q1a**) to “On” position.
3. Set the output switch (**Q2**) to “On” position.
4. Set the manual bypass switch (**Q5**) to “Off” position and replace the metal bracket (**BL**) and screws (**t2**). Load is on Static Bypass.



It is an important requirement for safety to replace the metal bracket (**BL**) to prevent accidental closure of Q5 which can result in interruption of power to the load and possible damage to the UPS.

5. Start up the inverter.

- a. The startup operation will be done through the keypad of the control panel ((3) from Figure 3).
 - b. Select “CNTL” and Press **(ENT)** into control submenu,
 - c. Select “ON” and Press **(ENT)** once.
 - d. Screen to start the unit up will appear, select “Yes” and pressing **(ENT)**.
6. After a few seconds (depending on the battery level), an alarm message will display, and **AT THIS MOMENT ONLY** is when the battery fuse holder disconnect on the UPS (**Q3**) can be closed.

! BATT. SWITCH OPEN, SWITCH IT ON



DO NOT TRY to close Q3 battery fuse disconnect at any other time or there may be damage to the UPS.

The UPS or UPS System is now online and fully protecting the load.

3.3.3 Emergency Transfer to Bypass

Procedure for switching to Static Bypass if LCD is damaged:

1. Remove cover to Remote Shutdown Switch (Q6). See [Figure 5](#) & [Figure 6](#)
2. Press Switch up to On position. The UPS will automatically transfer to Static Bypass.



If Remote Shutdown is up in the ON position, the inverter cannot be turned on.

4. Control Panel and Display

4.1 Basic Functions of Keyboard

The LCD front screen has touch screen functions. It also has buttons below the screen that has similar functions.

The advance (↑) and return (↓) keys, allows access to all the menus of the LCD panel, being able to move from one to another.

The right (→) or left (←) keys, allows access to the screens of all the submenus of the LCD panel, being able to move from one to another with themselves.

The Enter (**ENT**) key has different purposes depending on the menu.

The Escape (**ESC**) key will go to previous screen, unless in any screen of **Parameters** menu and setting any of them. If so, the first pulsation of Escape (**ESC**) key will stop blinking the value, and second one to go back to the previous screen.

Adjust Setting Values

- 1 Press (**ENT**) key to activate the function setting, the figures in the screen blink.
- 2 Use right (→) or left (←) keys the select character to set.
- 3 Use (↑) and return (↓) keys select the value.
- 4 To confirm press (**ENT**). Next field will blink.
- 5 To continue adjust settings repeat steps 1-4 or
- 6 Press (**ESC**) to exit.

4.2 Screen Description

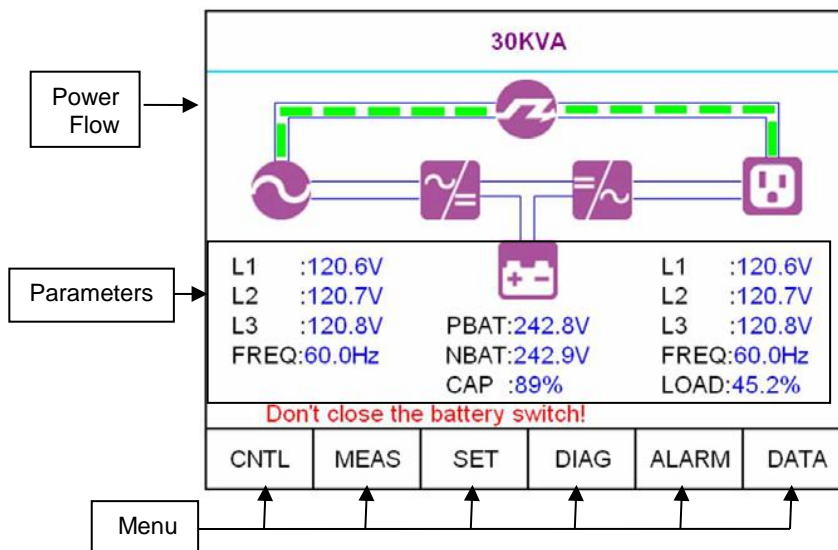

Figure 16 - Typical Main screen

4.2.1 Main Screen

The main screen will show the UPS power flow 1-line. This screen will display the following data:

- Input Line-Neutral Voltage (L1, L2, L3)
- Input Frequency
- Battery Positive-Half Voltage
- Battery Negative-Half Voltage
- Battery Capacity
- Output Line-Neutral Voltage (L1, L2, L3)
- Output Frequency
- Load Percentage

Using Escape (**ESC**) key or Home Icon from any screen of any submenu will return back to main screen.

4.2.2 Control (CNTL) Menu

This menu has basic controls of the UPS

- ON – Turns the UPS On (see [Section 3.1](#))
- OFF – Turns the UPS Off (see [Section 3.2](#))
- Bat. Test – Initiate a Manual Battery Test
- Back – Return to Main screen

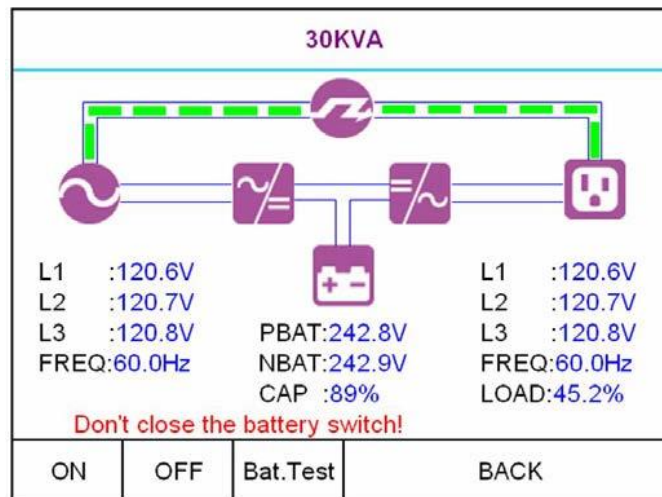

Figure 17 - Typical Control Screen

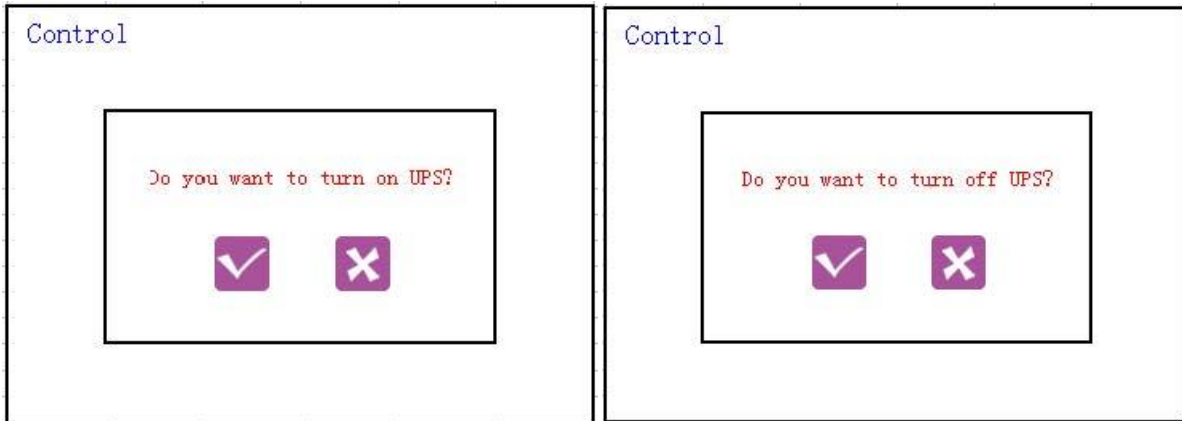

Figure 18 - UPS ON/OFF Screens

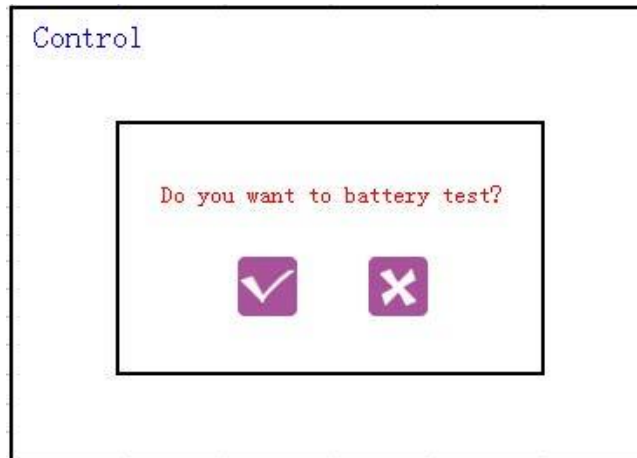

Figure 19 - Manual Battery Test Screen

4.2.3 Measure (MEAS) Menu

This menu shows measurement values:

Page 1

Input Voltage (V) and Current (A)

V12 - Phase A-B Voltage; V1N - Phase A-N Voltage; I1 – Phase A Current
 V23 - Phase B-C Voltage; V2N - Phase B-N Voltage; I2 – Phase B Current
 V13 - Phase A-C Voltage; V3N - Phase C-N Voltage; I3 – Phase C Current

Output Voltage (V) and Current (A)

V12 - Phase A-B Voltage; V1N - Phase A-N Voltage; I1 – Phase A Current
 V23 - Phase B-C Voltage; V2N - Phase B-N Voltage; I2 – Phase B Current
 V13 - Phase A-C Voltage; V3N - Phase C-N Voltage; I3 – Phase C Current

DC Bus Voltage (V)

P - Positive Half-String Voltage; N - Negative Half-String Voltage

Battery Voltage (V)

P - Positive Half-String Voltage; N - Negative Half-String Voltage

Page 2

Bypass Voltage (V) and Current (A)

V1N - Phase A-N Voltage; I1 – Phase A Current
V2N - Phase B-N Voltage; I2 – Phase B Current
V3N - Phase C-N Voltage; I3 – Phase C Current

Inverter Voltage (V) and Current (A)

V1N - Phase A-N Voltage; I1 – Phase A Current
V2N - Phase B-N Voltage; I2 – Phase B Current
V3N - Phase C-N Voltage; I3 – Phase C Current

Charging Current (A)

P - Positive Half-String Current; N - Negative Half-String Current

Discharging Current (A)

P - Positive Half-String Current; N - Negative Half-String Current

Page 3

Frequency

Input (Hz)

Bypass (Hz)

Output (Hz)

Temperature

Rectifier (°C)

Inverter (°C)

Battery (°C)

Input Apparent Power (VA) and Active Power (W)

L1: Phase A (VA); L1: Phase A (W)

L2: Phase B (VA); L2: Phase B (W)

L3: Phase C (VA); L3: Phase C (W)

Input Total Power

Total of all 3 phases (VA) & (W)

Input Power Factor

L1: Phase A; L2: Phase B; L3: Phase C

Page 4

Output Apparent Power (VA) and Active Power (W)

L1: Phase A (VA); L1: Phase A (W)

L2: Phase B (VA); L2: Phase B (W)

L3: Phase C (VA); L3: Phase C (W)

Output Total Power

Total of all 3 phases (VA) & (W)

Output Power Factor

L1: Phase A; L2: Phase B; L3: Phase C

Output % Load (%)

L1: Phase A; L2: Phase B; L3: Phase C

Total Load (%)

IN – Input Total Load; OUT – Output Total Load

Estimated Backup Time (Min)

Estimated of battery runtime at current load

4.2.4 Setting (SET) Menu

This menu shows values that can be adjusted:

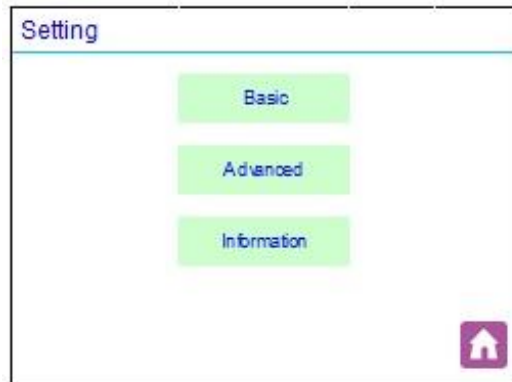

Figure 20 - Setting Menu

4.2.4.1 Basic Settings

Page 1

- Theme Setting – Change the color scheme of the front LCD screen
- Clock – Set time hh:mm:ss (hours/minutes/seconds)(24hr format)
- Date – Set date dd/mm/yy (day/month/year)
- Language – Set language on Front LCD screen
(US English\UK English \Chinese\Japanese\German\Spanish\French)
- Modbus Adress - (1-246)
- Service Phone Number - (XXXX-XXXXXXX)
- Service Contactor – Set name of Service Contractor
- Service Mail – Set Service Contractor's email address
- Service Address – Set Service Contractor's mailing address

Page 2

- Port 0 Baud Rate – Set Baud rate for port #0 (1200/2400/4800/9600/19200)
- Port 0 Parity – Set Parity type for Port #0 (None/Odd/Even)
- Port 0 Stop Bits – Set number of Stop Bits for Port #0 (1/2)
- Port 0 Protocol – Set protocol type for Port #0 (Sec/Modbus)
- Port 2 Baud Rate – Set Baud rate for Port #2 (1200/2400/4800/9600/19200)
- Port 2 Parity – Set Parity type for Port #2 (None/Odd/Even)
- Port 2 Stop Bits – Set number of Stop Bits for Port #2 (1/2)
- Port 2 Protocol – Set protocol type for Port #2 (Sec/Modbus)

Page 3

- Automatic Battery Test Setting:
 - Type – How often the battery test is performed (Disabled/Weekly/Monthly/Yearly)
 - Weekday – If Type is set to “Weekly”, sets day of the week the test will start (Mon/Tue/Wed/Thu/Fri/Sat/Sun)
 - Hour:Minute – If automatic battery test is enabled, set time of day the test starts (hh:mm – 24-hr format)
 - Month/Day – If battery test is set for “Monthly” or “Yearly”, sets month and day of month the test will start.
- Application Setting – Set to 3Ph_4Wire
- Buzzer permanently muted – “Yes” will disable audible alarm, “No” will allow audible alarms

4.2.4.2 Advanced Setting



Password (01899) must be entered to activate write access to any Advance menu options.

Rate Values

These setting are not recommended to be changed without factory authorization.

Parameters

These setting are not recommended to be changed without factory authorization except for the following if unit is part of parallel system: Page 3 – Parallel Address, Parallel Unit, and Parallel Total Number

Calibration

These setting are not recommended to be changed without factory authorization.

System Initial

These setting are not recommended to be changed without factory authorization.

4.2.4.3 Information

Shows the configuration of UPS

Page 1

LCD Version
DSP Version
UC Version
Serial Number
Service Phone*
Service Contractor*
Service email*
Service Address*

Page 2

Input Voltage**
Output Voltage**
IP. V Min Margin**
IP.V. Max Margin**
Bps. V Min Margin**
Bps.V. Max Margin**
DC Bus Voltage**
OP. Current**
Battery Charging Current**
UPS Configuration**

*Service Information is set in Basic Setting Menu (see [Section 4.2.4.1](#))

**Rated Values are set in Rated Values settings (see [Section 4.2.4.2](#))

4.2.3 ALARM

When Alarms appear in the Main Menu, only one alarm is visible. The Alarm Menu will list all active alarms.

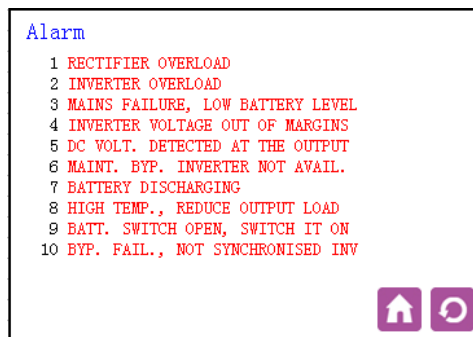

Figure 21 - Alarm Screen

[Appendix A](#) lists all the possible alarms that can be displayed.

5. Maintenance

5.1 Basic Maintenance Guide



The uninterruptible power system is designed and produced to last, even in the most severe service conditions. It is an electronic power unit, which requires periodic maintenance. Moreover, some components have a limited lifespan and as such must be periodically checked and replaced should conditions so dictate: in particular the batteries, the fans and in some cases the electrolytic capacitors. It is therefore recommended to implement a preventive maintenance program with a specialized personnel authorized by the manufacturer. Our Technical Support Team will be happy to recommend the various personalized options for preventive maintenance.

5.1.1 Periodic maintenance (to be carried out by trained personnel and with doors closed)

The following operations should be carried out periodically (e.g. once a month, or more frequently in particularly difficult environmental conditions):

- Ensure that the air intake slots (located on the front door and at the back of the cabinet) and the output grilles located on the top of the cabinet are clean;
- Perform a battery test.

5.1.2 Maintenance inside the UPS (factory authorized personnel only)

Danger



Maintenance inside the UPS may only be carried out by trained personnel. The UPS is designed to power the load when it is disconnected from the mains power supply.

High voltage is present inside the UPS even when the mains power supply and the battery have been disconnected.

After disconnecting the input utility and the battery source, trained service personnel must wait at least ten minutes for the capacitors to discharge before working on the inside of the UPS.

5.1.3 Ordinary maintenance for batteries (trained personnel only)

The system automatically controls the efficiency of the batteries every 24 hours, and sounds an alarm when the efficiency is lower than that calculated, according to the stored capacity value.

The lifespan of the batteries is linked to the operating temperature and to the number of charge and discharge cycles the battery has experienced.

The capacity is not constant, but increases after some charge and discharge cycles; it then remains constant for several hundreds of cycles before decreasing permanently.

Preventive maintenance of the battery:

- Keep the operating temperature within the range of 20 - 25°C;
- Perform two or three discharge and charge cycles during the first month of use;
- Repeat this operation every six months after the first month of use.

Danger



Maintenance inside the UPS may only be carried out by trained personnel.

Since the batteries are a source of energy, opening the battery circuit breaker/disconnect does not eliminate the voltage inside the battery cabinet. **DO NOT TRY TO ACCESS THE INSIDE OF THE BATTERY CABINET. THERE ARE ALWAYS DANGEROUS VOLTAGES FROM THE BATTERIES.** If the batteries are thought to be faulty in any way, please contact Staco technical support.

Warning



If the batteries need to be replaced, this must be done by **factory authorized personnel**. The replaced parts must be sent to a specialized company for disposal by means of recycling. Batteries are classified by law as “toxic waste”.

5.2 Internal Battery Replacement

Danger



The internal battery compartment contains high voltage and should only be serviced by qualified technical personnel. Battery trays are very heavy. Removing a battery tray from the UPS should only be done with the use of a mechanical lift (fork lift).

When replacing batteries use only the same type and size rating as the battery being replaced.

1. Verify the UPS is completely off and the mains power is disconnected. Open the battery fuse disconnect Q3.
2. Remove the side panels from both sides of the cabinet.
3. Locate the large battery connector between the battery compartment and the front panel as shown in [Figure 22](#).



Battery Connector

Battery Mounting
Screws

Figure 22 - UPS Internal Battery trays

4. Pull the two halves of the battery connector apart to disconnect the battery.
5. The batteries are mounted into two trays that bolt down to the chassis as shown in [Figure 22](#). Remove all of these bolts.



Before disconnecting any battery wires they should be marked to identify where they were connected. The battery string is made up of 36 batteries with three connections at Positive, Center Tap, and Negative. The wires from the battery connector are as follows: Red to Positive, Blue to center tap, and black to Negative.

6. Carefully slide top tray out of the battery compartment just enough to expose the battery terminals. Locate the wires from the battery connector that connect to the batteries on the top tray and disconnect those wires from the batteries. The tray may need to slide out slightly in both directions to access all of the battery connection wires, depending on the size battery that is installed. The top tray is now free to completely remove from the battery compartment.
7. Repeat the previous step to remove the bottom tray.
8. Insure that the replacement batteries are installed in the trays in exactly the same orientation as the original factory installation.
9. Install the battery trays starting with the bottom tray. Insure the proper wire termination is made based on the color of the connector.
10. Once both trays are installed and all of the connections are made you can reconnect the multi-colored battery connector halves.

Replace the cabinet sides and follow the startup procedure to restart the UPS. [See Section 3.1](#)

5.3 Recommended Replacement Intervals

The Staco UPS has a long design life. Due to the characteristics of the part, not the design of the UPS, certain components used in the design have a limited life, even with proper maintenance.



Service and maintenance work must be performed only by factory authorized personnel.

Staco recommends these limited-life components be periodically inspected and replaced before the expected expiration of their life cycle. The recommended replacement schedule is an estimate only. The life of these parts depends on site conditions such as ambient temperature, load profile, cleanliness of environment and other factors. See Section **6.1 Technical Specifications**

Staco Recommends a Factory Authorized Preventative Maintenance review is schedule at least once a year.

Component	Recommend Replace in:
Fans	4-6 years
Batteries	4 years
AC Filter Capacitors	4-6 years
DC Filter Capacitors	4-6 years

Table 2 - Recommended Replacement Intervals

The functional lifetime of batteries is significantly affected by the temperature at which they are stored and operated. Ideally, batteries should be used in a 21° C (70° F) environment. For every 8.3° C (15° F) increase in temperature, the life expectancy of a battery will be halved.

Exposure to temperatures in excess of 32° C (90° F) should be limited to no more than 30 days per year. Under no circumstances should the battery be exposed to temperatures over 40° C (104° F) which can lead to thermal runaway, a condition that damages the battery. Thermal runaway can cause batteries to swell. If the battery cases burst, the hazardous contents may be exposed.

Maintaining proper ambient temperature usually requires installing the product in a temperature controlled space. Equipment rooms without cooling systems do not generally maintain the proper conditions for good battery life.

6. Specifications

6.1 Technical Specifications

UPS Rating kVA/kW	10/9	15/13.5	20/18	30/27	40/36
Input					
Voltage	208 VAC, Three Phase, 4 wire plus ground				
Range	+15% / -20% (Battery Discharge@-15% with full load)				
Frequency	50/60Hz +/- 5.0 Hz				
Power Factor	0.99 at 100% load, 0.98 minimum at 50% load				
Reflected Current Distortion (THD)	Less than 1% (100% load), Less than 2% (50% load), less than 5% (10% load)				
Input Current	Nom: 28A Max: 33A	Nom: 42A Max: 49A	Nom: 55A Max: 65A	Nom: 83A Max: 97A	Nom: 111A Max: 130A
Input Current Inrush	No inrush current on startup, Input current increases from zero to 100% in less than 10 seconds				
Output					
Voltage	208 VAC, Three Phase, 4 wire plus ground				
Static Voltage Regulation	+/- 2%				
Voltage Transient Response	Voltage transient response shall not exceed the following, and shall recover to 95% within 10 milliseconds: a) +/- 15% at the first cycle for a 100% step load b) +/- 1% (loss or return of AC input)				
Frequency (inverter synchronous)	60Hz (tracks frequency of static bypass source) +/-, 0.5, 1.0, 2.0, 5.0 Hz (user settable).				
Frequency Slew Rate	± 10 Hz per second (inverter synchronized to static bypass)				
Free Running Frequency	60Hz +/- 0.01Hz (on battery or asynchronous)				
Voltage Distortion (THD)	Less than 1% (Linear load), Less than 2% with crest factor 2.5 to 1				
Inverter Overload	125 % for 10 min, 150 % for 60 sec				
Bypass Overload	400% for 10 seconds , 1000% for half line cycle				
Bypass Input Synch Voltage Range	-0.8				
Bypass Input Frequency Tracking Range	+/- 5Hz				
Inverter Efficiency	Up to 94%				
Overall Efficiency	Up to 93%				
Output Current	28A	42A	55A	83A	111A
Heat Rejection (BTU/Hr) @ 100% load	2500	3800	5000	7500	10000
Battery					
Charger Current @ Full Load	5.9A	8.6A	11.6A	17.2A	24.1A
Environmental					
Altitude	< 2000 meters Derate load capability above 1000 meters 1% per 100 meters				
Operating Temperature	0 ~ 40°C				
Audible Noise (dbA)	<69		<75		
General					
Dimensions (DxWxH)	31.7 in (805mm) x 20.3 in (515mm) x 47.25 in (1200mm)		32.7 in (830mm) x 23.25 in (590mm) x 52 in (1320mm)		
Weight	408lbs (185 kg)		585lbs (265 kg)		
Standards	UL listed to 1778, CUL to CSA C22.2, NEMA PE-1, ASME, ASA-C-39.1-1984, FCC Part 15 Subpart J Class B, NEC, OSHA, IEEE587, ANSI C 62.41-1980, ISO9000, 14000				

6.2 Battery Runtime

kVA	CSB Battery	Strings	0.9 pf Run Time
10-3	HRL 1234W	1	9.1
10-2	HR 1251W	1	18.1
10-1	HR 1290W	1	37.5
15-3	HRL 1234W	1	3.6
15-2	HR 1251W	1	10.3
15-1	HR 1290W	1	21.4
20-2	HR 1251W	1	6.6
20-1	HR 1290W	1	14.6
30-1	HR 1290W	1	8
40-1	HR 1290W	1	4.2



Runtime is approximate depending on several factors including battery age and condition.

Danger



There is a risk of damage if batteries are replaced by an incorrect type. Replace with same type and rating only.

6.3 Rated Currents and Field Wiring Information

Model	kVA/kW	Current (A)			Field Wiring	
		Input	Bypass/ Output	Battery	AWG IP / OP / Bat	Torque
FLP-010 / FLP-924-9	10/9	28	28	26	10 / 10 / 10	49.5 lb-in
FLP-015 / FLP-924-13	15/13.5	40	41	39	8 / 8 / 8	49.5 lb-in
FLP-020 / FLP-924-18	20/18	53	55	53	4 / 6 / 6	49.5 lb-in
FLP-030 / FLP-924-27	30/27	80	82	79	3 / 4 / 4	70 lb-in
FLP-040 / FLP-924-36	40/36	107	110	105	1/0 / 2 / 2	70 lb-in

NOTE 1: It is recommended to use 75°C copper wire.

NOTE 2: Recommended cable sized based on THW cables at 30°C ambient (NEC Table 310.16). If different cables are used or installed at higher ambient, the cable size need to be reviewed.

NOTE 3: Any external battery wires use reinforced insulation or double insulated wire.

Appendix A – Alarms

<u>Alarm #</u>	<u>Alarm Name</u>	<u>Definition</u>
1	Rectifier Overload.	Indicates that the rectifier is overloaded. The rectifier overload appears when the input current of any phase is greater than the following ratio: $I_{in-ovl} = 0,326 \times P_{out} / V_{out_p-n}$ Where: - I_{in-ovl} is Overload Input Current (A) - P_{out} is Rated Output Apparent Power (VA) - V_{out_p-n} is Rated Output Voltage phase-to-neutral (V)
2	Inverter Overload.	Indicates that the inverter is overloaded. The inverter overload appears either when the output current of any phase is greater than the rated output current $I_{out-ovl} = P_{out} / (V_{out_p-n} \times 3)$ Where: <ul style="list-style-type: none"> • I_{out} is rated Output Current (A) • P_{out} is Rated Output Apparent Power (VA) • V_{out_p-n} is Rated Output Voltage phase-to-neutral (V) or when the total output active power is greater than the following formula: $P_{act_out-ovl} = P_{out} \times 0,8$ Where: <ul style="list-style-type: none"> • $P_{act_out-ovl}$ is the Overload Output Active Power (W) • P_{out} is Rated Output Apparent Power (VA)
3	Mains Failure. Battery Low Level.	Appears when the input the unit is under main failure condition and the level of battery is lower than 11.5V/bat.
4	Inverter Voltage Out of Margins.	Appears when the inverter output voltage phase to neutral in any phase is out of margins over +/-6%.
5	DC Voltage Detected at the Output.	Appears when there is an offset voltage higher than 5V, in any phase of the inverter output voltage phase to neutral.
6	Maintenance Bypass. Inverter Not Available.	When the maintenance bypass switch is ON the UPS inverter will not be available.
7	Battery Discharging.	The mains failure occurs when any phase to neutral voltage is out of the set margins (Default: +15%/-20%) or the input frequency is out of the set margins (Default: ± 0.5Hz).
8	High Temperature. Reduce Output Load.	When the inverter or PFC temperature sensors measure temperatures over the programmed values (Default: 70°C).
9	Battery Switch Open. Switch it ON.	Signals to turn Battery switch to ON position when the battery switch is OFF and the DC bus is charged to the battery voltage level.
10	Bypass Failure. Not Synchronised Inverter.	Indicates that the bypass input voltage (Default: +12%/-17%) or the bypass input frequency (Default: ±0.5Hz.) are out of programmable margins.
11	Unit on Bypass. Initialise UPS.	The UPS is on bypass for any reason. It must be restarted by display keypad.
12	Some Unit(s) Blocked due to Maintenance Bypass.	<u>For parallel systems.</u> It appears when some UPS of the parallel system block because the maintenance bypass switch of any unit is switched ON.
13	CAN BUS 1 Communication Failure.	Indicates that the CAN BUS #1 fails. This communication channel is used for remote control.
14	CAN BUS 2 Communication Failure.	<u>For parallel systems.</u> Indicates that the CAN BUS #2 fails. This channel is used for data communication between UPS's.
15	End of Battery Life.	The estimated end of life of the battery bank.
16	Battery Temperature too High.	The temperature of battery cabinet (in case of separate battery cabinet) or battery place (in case of battery are located inside the UPS) is higher than 40°C.
17	Battery Test Not Succeeded.	Battery test (automatic or manual) is unsuccessfully.

Alarm #	Alarm Name	Definition
18	Battery Disconnection. Shutdown & Restart.	Two possible reasons: <ul style="list-style-type: none"> • During the unit start up, message appears indicating that the battery switch can be switched ON. After some period of time without switching ON, this alarm appears. • When the unit is running under normal conditions and the battery switch is switched OFF.
19	Mains Phase Rotation. UPS Start Disabled.	Input phase rotation error is detected and the start up procedure is inhibited.
20	Bypass Phase Rotation. UPS Start Disabled.	Bypass phase rotation error is detected and the start up procedure is inhibited.
21	Input Voltage Wrong. Rectifier Stop.	Any rectifier input voltage phase to neutral is out of the set margins (Default: +15%/-20%) or the rectifier input frequency is out of the set margins (Default: $\pm 0,5\text{Hz}$). Then the rectifier is shut down.
22	Rectifier Desaturation. Rectifier Stop.	Any IGBT in the rectifier side, desaturates the number of times programmed by display (Default: 50).
23	DSP Internal Error. Rectifier Stop.	Appears when there is a DSP Internal Error* in the rectifier module, shutting down the rectifier immediately. There will be 3 more retries before the rectifier blocking.
24	Input Phase Rotation. Rectifier Stop.	When a mains phase rotation error is detected and the rectifier is attempted to be turned ON, an input phase rotation alarm appears shutting down the rectifier.
25	Inverter Desaturation. Inverter Stop.	Appears when any IGBT in the inverter side, de-saturates the number of times programmed by display (Default: 200).
26	Inverter Overload. Inverter Stop.	When the inverter output is overloaded. Depending on the level of this overload, the inverter will be shut down after some time according to the UPS overload curve.
27	Inverter Stopped due to Shutdown.	When an external shutdown signal is enabled. The inverter will shut down.
28	Maintenance Bypass. Inverter Stop.	When the inverter is running and the maintenance bypass switch is turned ON the inverter shuts down immediately.
29	Parallel System Disconnection. Inverter Stop.	<u>For parallel systems.</u> Appears when, in a parallel system, one UPS goes to battery mode. The inverter will shut down.
30	High Overload. Inverter Stop.	<u>For parallel systems.</u> This message indicates that one UPS is running over 160% of load in a parallel system.
31	Overtemperature. Inverter Stop.	When an over temperature is detected by the PFC or inverter temperature sensors. After 1 minute, the inverter will be turned off automatically. If over temperature condition remains after another 1 minute with the rectifier working, rectifier is also blocked (see Alarm 60).
32	Rectifier Overload. Inverter stop	The rectifier is overloaded, depending on the level of this overload, the inverter will be shut down after some time according to the rectifier overload curve. If this overload is still present with the inverter switched off, the rectifier will be blocked after 30 seconds and a blocking alarm 61 will appear.
33	DSP Internal Error. Inverter Stop.	This alarm appears when there is a DSP Internal Error* in the inverter module, shutting down the inverter immediately. There will be 4 more retries before the inverter blocking.
34	Output Short-circuit. Inverter Stop.	Appears when an output short-circuit is detected limiting the output RMS current up to the set value (Default: 150% of nominal current). The short-circuit is detected when the output voltage phase to neutral is lower than 8% of nominal voltage. The system will retry restart two times.
35	Bypass Phase Rotation. Inverter Stop.	With the inverter is running and a bypass phase rotation error, the inverter will shut down.

Alarm #	Alarm Name	Definition
36	Low Battery. UPS Stop.	Appears when there is a DSP Internal Error* in the UPS module, shutting down the UPS immediately. There will be 2 more retries before the UPS blocking.
37	DSP Internal Error. UPS Stop.	In battery mode, the battery bank reaches the 10.5V/bat. This is the end of backup time, shutting down the UPS.
38	Emergency Power Off. No Output Voltage.	The EPO (Emergency Power Off) switch is ON. The UPS and the static bypass are switched off and no AC voltage present at the output anymore.
39	Output Short-circuit. No Output Voltage.	Appears after detecting output short-circuit 3 times. Then the UPS and the static bypass are switched off and no AC voltage present at the output anymore.
40	DSP Internal Error. UPS Block All.	Appears when there is a DSP Internal Error* in the UPS module, for three times shutting down the UPS. The UPS blocks including the bypass, so no AC voltage present at the output anymore.
41	DC BUS Voltage Wrong. Rectifier Block.	This alarm appears when there is one of the following conditions: <ul style="list-style-type: none"> • Positive DC bus voltage over 275V. • Positive DC bus voltage less than 200V. • Negative DC bus voltage over -275V (absolute value).
42	Rectifier Blocked. BLK. UPS -> BLK Rectifier.	Appears when the UPS is blocked for any reason. This condition also blocks the rectifier.
43	Rectifier Desaturations. Rectifier Block.	After 3 attempts to shut down the rectifier for desaturation and retry.
44	Voltage Ramp Error. Rectifier Block.	An error in the initial rectifier ramp is detected during the PFC start up.
45	DSP Execution Error. Rectifier Block.	There is a command from the microprocessor to the DSP, with no response from the rectifier module of the DSP.
46	DSP Internal Error. Rectifier Block.	After 4 attempts shutting down the rectifier because of DSP Internal Error* in the rectifier module.
47	Contactors Test Failure. Rectifier Block.	The input contactor test failed during start-up.
48	Voltage Ramp Error. Inverter Block.	The output voltage ramp doesn't work properly during the inverter start up the inverter will be blocked (See Alarm 67).
49	Output DC Voltage. Inverter Block.	Appears when there is an offset voltage higher than 8V, in any phase of the inverter output voltage phase to neutral. Then the inverter will be blocked.
50	Inverter Blocked. BLK. UPS -> BLK Inverter.	Appears when the UPS is blocked for any reason. This condition blocks also the inverter.
51	Inverter Desaturations. Inverter Block.	After 3 attempts shutting down the inverter for desaturation and retry.
52	DSP Execution Error. Inverter Block.	There is a command from the microprocessor to the DSP, with no response from the inverter module of the DSP. The inverter will block.
53	DSP Internal Error. Inverter Block.	After 5 attempts shutting down the inverter because of DSP Internal Error* in the inverter module.
54	UPS Blocked. BLK. Rectifier -> BLK. UPS.	Appears when the rectifier is blocked for some reasons that can also blocks the UPS.
55	Internal Initialisation Error. UPS Block (DSP).	Appears when the DSP doesn't response to the microprocessor during the initial procedure before the start up.
56	Internal Execution Error. UPS Block (DSP).	There is a command from the microprocessor to the DSP, with no response from the UPS module of DSP. The UPS will block.
57	UPS Blocked. BLK. Inverter -> BLK. UPS.	Appears when the inverter is blocked for some reasons that can also blocks the UPS.
58	Internal Communication. UPS Block (DSP).	There is an internal error in the communication channel between microprocessor and DSP.
59	Parallel System Discharging. UPS Block.	<u>For parallel systems.</u> Appears when one UPS goes to battery mode. After some period of time, the UPS will shut down.

Alarm #	Alarm Name	Definition
60	UPS Overtemperature. UPS Block.	When an overtemperature is detected by the PFC or inverter temperature sensors, first the inverter will be turned off automatically after 1 minute time (see Alarm 31). If one minute later the overtemperature is still detected, the UPS will be completely blocked (rectifier also shut-down) and the alarm appears.
61	Rectifier Overload. UPS Block.	When the rectifier is overloaded, depending on the level of this overload, the inverter will be shut down after some time according to the rectifier overload curve (see Alarm 32). If this overload is still present with the inverter switched off, the UPS will be completely blocked (rectifier also shut-down) after seconds.
62	Inverter Desaturations. UPS Block.	When any inverter IGBT desaturates the number of times programmed by display (default: 200t) the inverter blocks. After two more attempts this alarm appears indicating UPS blocked.
63	DSP Internal Error. UPS Block.	After 3 attempts shutting down the UPS because of DSP Internal Error* in the UPS module.
64	PFC & Inverter Blockage. UPS Block.	There is a blocking condition for the inverter and also a blocking condition for the PFC.
65	Inverter Failure/Overload. Inverter Stop.	This alarm can be activated due to a connection of a load with high inrush current, or also, if it is detected a wrong transient voltage in the inverter (i.e., if there is a fault in an inverter transistor. The inverter will shut down for a while and load will be transferred to bypass immediately. The UPS will attempt to start up the inverter several times (see Alarm 66)
66	Inverter Failure. Inverter Block	After several attempts detecting "Inverter Fault/Overload" (see Alarm 65), the inverter will be blocked permanently, and output will be transferred to bypass.
67	Voltage Ramp Error. Inverter Stop.	During voltage ramp any fault is detected, the inverter will be shut down, and it will attempt to start it up several times (see Alarm 48). (During Voltage ramping, rms value from sine wave voltage starts at 0Vrms until reaching its preset nominal value, i.e., 230Vrms).
68	DC BUS Voltage Wrong. Rectifier Stop.	High or low DC bus voltage is detected. Rectifier is shut down, in order to retry to start up later on (see Alarm 41).
69	Parallel System Rectifier Stop.	<u>For parallel systems.</u> Rectifiers from the UPS of the system connected in parallel can be shut down, due to the management of system as a whole.
70	Parallel System Inverter Stop.	<u>For parallel systems.</u> Inverters of the UPS of the system connected at the output can be shut down, due to the management of system as a whole.
71	Pfc., Inv. Stop UPS Stop.	Combined shutdown of the PFC-rectifier and inverter has been done at the same time.
72	Parallel System UPS Stop.	<u>For parallel systems</u> UPS of the system connected at the output can be shut down (complete shutdown of the rectifier and inverter), due to the management of system as a whole.
73	Error Coms. Paral. Master Fixed.	<u>For parallel systems</u> One UPS (or more) that detect(s) communication errors, due to several reasons (parallel communication cables are disconnected, wrong connected, in bad status, wrong configuration of any of the units; etc.). Therefore, one UPS is set as a fixed Master of the system, and the rest of the units can only be slaves permanently (or till UPS is shut down and they will be started up again to test).
74	Alarm Paral. Sist. Redundancy Lost.	<u>For parallel systems</u> With N+M configuration, where: N: # units to size the system according to the maximum permissible load. M: # redundant units in the system. The alarm is displayed when the load exceeds the maximum permissible load by N units. In this condition, the UPS are not overloaded individually; meanwhile the load doesn't exceed the maximum load of N+M units.

Alarm #	Alarm Name	Definition
75	Cont. Test Fail Rectifier Stop.	Input contactor from the UPS faults. The DC bus voltage is not kept at certain level when closing input contactor. (see Alarm 47).
76	Paral. Coms Error UPS Block.	<u>For parallel systems</u> After the first error in the parallel system communication, when one UPS has already been chosen as a Fix Master in the system, a second error or break in the communications has been detected by the Slave unit(s) Unit will be blocked permanently (Rectifier and Inverter are shutdown, output voltage is not supplied to the output of the system).
77	EEPROM Failure.	Error in configuration memory

(*) DSP Internal Error can happen for the following reasons:

- Watch Dog failure.
- Wrong ADC measures.
- Communication errors between DSP and processor.